



# Maintenance and Service Guide

## **SUMMARY**

This guide provides information about spare parts, removal and replacement of parts, security, backing up, and more.

© Copyright 2020 HP Development Company, L.P.

Bluetooth is a trademark owned by its proprietor and used by HP Inc. under license. Intel, Core, Iris, Optane, Thunderbolt, vPro, and XMM are trademarks of Intel Corporation or its subsidiaries in the U.S. and/or other countries. Microsoft and Windows are either registered trademarks or trademarks of Microsoft Corporation in the United States and/or other countries. NVIDIA, GeForce, and Optimus are trademarks and/or registered trademarks of NVIDIA Corporation in the U.S. and other countries. The microSD Logo and microSD are trademarks of SD-3C LLC. USB Type-C and USB-C are registered trademarks of USB Implementers Forum. DisplayPort™ and the DisplayPort™ logo are trademarks owned by the Video Electronics Standards Association (VESA®) in the United States and other countries. Miracast is a registered trademark of Wi-Fi Alliance.

The information contained herein is subject to change without notice. The only warranties for HP products and services are set forth in the express warranty statements accompanying such products and services. Nothing herein should be construed as constituting an additional warranty. HP shall not be liable for technical or editorial errors or omissions contained herein.

First Edition: October 2020

Document Part Number: M11679-001

## Product notice

This guide describes features that are common to most models. Some features may not be available on your computer.

Not all features are available in all editions or versions of Windows. Systems may require upgraded and/or separately purchased hardware, drivers, software or BIOS update to take full advantage of Windows functionality. Windows 10 is automatically updated, which is always enabled. ISP fees may apply and additional requirements may apply over time for updates. Go to <http://www.microsoft.com> for details.

To access the latest user guides, go to <http://www.hp.com/support>, and follow the instructions to find your product. Then select **Manuals**.

## Software terms

By installing, copying, downloading, or otherwise using any software product preinstalled on this computer, you agree to be bound by the terms of the HP End User License Agreement (EULA). If you do not accept these license terms, your sole remedy is to return the entire unused product (hardware and software) within 14 days for a full refund subject to the refund policy of your seller.

For any further information or to request a full refund of the price of the computer, please contact your seller.

## Safety warning notice

Reduce the possibility of heat-related injuries or of overheating the computer by following the practices described.

---

 **WARNING!** To reduce the possibility of heat-related injuries or of overheating the computer, do not place the computer directly on your lap or obstruct the computer air vents. Use the computer only on a hard, flat surface. Do not allow another hard surface, such as an adjoining optional printer, or a soft surface, such as pillows or rugs or clothing, to block airflow. Also, do not allow the AC adapter to come into contact with the skin or a soft surface, such as pillows or rugs or clothing, during operation. The computer and the AC adapter comply with the user-accessible surface temperature limits defined by applicable safety standards.

---



---

# Table of contents

<b>1 Product description .....</b>	<b>1</b>
<b>2 Components .....</b>	<b>6</b>
Right .....	6
Left .....	7
Display .....	8
Keyboard area .....	9
Touchpad .....	9
Touchpad settings .....	9
Adjusting touchpad settings .....	9
Turning on the touchpad .....	9
Touchpad components .....	10
Lights .....	10
Button, speakers, and fingerprint reader .....	11
Special keys .....	13
Hot keys (select products only) .....	14
Bottom .....	14
Rear .....	15
Labels .....	15
<b>3 Illustrated parts catalog .....</b>	<b>18</b>
Computer major components .....	18
Display assembly subcomponents .....	20
Cable Kit .....	22
Miscellaneous parts .....	22
<b>4 Removal and replacement procedures preliminary requirements .....</b>	<b>25</b>
Tools required .....	25
Service considerations .....	25
Plastic parts .....	25
Cables and connectors .....	25
Drive handling .....	25
Workstation guidelines .....	26
Electrostatic discharge information .....	26
Generating static electricity .....	27
Preventing electrostatic damage to equipment .....	27

Personal grounding methods and equipment .....	28
Grounding the work area .....	28
Recommended materials and equipment .....	28
Packaging and transporting guidelines .....	29

## **5 Removal and replacement procedures for authorized service provider parts ..... 30**

Component replacement procedures .....	30
Preparation for disassembly .....	30
Bottom cover .....	30
Battery .....	31
Memory modules .....	33
WLAN module .....	34
WWAN module .....	36
Solid-state drive .....	38
RTC battery .....	39
I/O board .....	39
Touchpad .....	40
Fan .....	41
Fingerprint reader board .....	42
Heat sink .....	43
System board .....	45
Speakers .....	48
Power connector cable .....	49
Display assembly .....	50
Top cover with keyboard .....	57

## **6 Computer Setup (BIOS), TPM, and HP Sure Start ..... 59**

Using Computer Setup .....	59
Navigating and selecting in Computer Setup .....	59
Restoring factory settings in Computer Setup .....	59
Updating the BIOS .....	60
Determining the BIOS version .....	60
Preparing for a BIOS update .....	60
Downloading a BIOS update .....	60
Installing a BIOS update .....	61
Changing the boot order using the f9 prompt .....	61
TPM BIOS settings (select products only) .....	61
Using HP Sure Start (select products only) .....	62

<b>7 Backing up, restoring, and recovering .....</b>	<b>63</b>
Backing up information and creating recovery media .....	63
Using Windows tools for backing up .....	63
Using the HP Cloud Recovery Download Tool to create recovery media (select products only) .....	63
Restoring and recovering your system .....	63
Creating a system restore .....	64
Restoring and recovery methods .....	64
Recovering using HP Recovery media .....	64
Changing the computer boot order .....	64
Using HP Sure Recover (select products only) .....	65
<b>8 Using HP PC Hardware Diagnostics .....</b>	<b>66</b>
Downloading the HP PC Hardware Diagnostics Windows from the Microsoft Store .....	66
Customizing Remote HP PC Hardware Diagnostics UEFI settings .....	66
<b>9 Specifications .....</b>	<b>67</b>
Computer specifications .....	67
39.6 cm (15.6 in) display specifications .....	67
Solid-state drive specifications .....	68
<b>10 Statement of memory volatility .....</b>	<b>70</b>
Current BIOS steps .....	70
Nonvolatile memory usage .....	72
Questions and answers .....	74
Using HP Sure Start (select products only) .....	75
<b>11 Statement of memory volatility .....</b>	<b>76</b>
Current BIOS steps .....	76
Nonvolatile memory usage .....	78
Questions and answers .....	80
Using HP Sure Start (select products only) .....	81
<b>12 Power cord set requirements .....</b>	<b>82</b>
Requirements for all countries .....	82
Requirements for specific countries and regions .....	82
<b>13 Recycling .....</b>	<b>84</b>
<b>Index .....</b>	<b>85</b>





# 1 Product description

This table provides detailed product information.

**Table 1-1 Product components and their descriptions**

Category	Description
<b>Product Name</b>	<b>HP ProBook 450 G8 Notebook PC</b>
<b>Processors</b>	<p><b>Intel® processors</b></p> <p>Intel Core® i7-1185G7 (3.0 GHz, 4 cores, 3200 MHz, 12 MB L3 cache, 15 W)</p> <p>Intel Core® i7-1165G7 (2.8 GHz, 4 cores, 3200 MHz, 12 MB L3 cache, 15 W)</p> <p>Intel Core i5-1135G7 (2.4 GHz, 4 cores, 3200 MHz, 8 MB L3 cache, 15 W)</p> <p>Intel Core i3-1115G7 (3.0 GHz, 2 cores, 3200 MHz, 6 MB L3 cache, 15 W)</p>
<b>Graphics</b>	<p><b>Internal graphics</b></p> <p>Intel Iris® Xe Graphics</p> <p><b>Discrete graphics</b></p> <p>NVIDIA® GeForce® MX450 graphics</p> <p>Supports CUDA, Optimus™, PhysX, GPU Boost 2.0</p> <p>Supports HD Decode, DX12, and HDMI 1.4b, HDCP 2.3 via DisplayPort up to 4 K @ 60 Hz</p> <p>Supports maximum of three independent displays when on the HP USB-C Dock G4; Max resolution = 4 K @ 30 Hz (DisplayPort 1 and DisplayPort 2)</p> <p>Supports maximum of three independent displays when on the HP Thunderbolt™ Dock 120 W G2 (through USB-C); Max resolution = 4 K @ 30 Hz (DisplayPort 1 and DisplayPort 2)</p>
<b>Display</b>	<p><b>39.6 cm (15.6 in), full high definition (FHD) (1920 × 1080), UWVA, narrow bezel, antiglare, bent</b></p> <p>250 nits, 45% CG, eDP 1.2 without PSR, no camera</p> <p>250 nits, 45% CG, eDP 1.2 without PSR, HD camera</p> <p>250 nits, 45% CG, eDP 1.2 without PSR, HD + IR camera</p> <p>250 nits, 45% CG, eDP 1.2 without PSR, HD camera, WWAN models</p> <p>250 nits, 45% CG, eDP 1.2 without PSR, HD camera, Touch-on Panel (TOP)</p> <p>250 nits, 45% CG, eDP 1.2 without PSR, HD camera, Touch-on Panel (TOP), WWAN models</p> <p>400 nits, sRGB 100, eDP, low power, HD camera</p> <p>400 nits, sRGB 100, eDP, low power, HD + IR camera</p> <p>1000 nits, 72% CG, eDP 1.4 + PSR2, SVG3, HD + IR camera</p> <p>1000 nits, 72% CG, eDP 1.4 + PSR2, SVG3, HD camera</p> <p><b>High definition (HD) (1366 × 768), SVA, narrow bezel, antiglare, bent</b></p> <p>250 nits, 45% CG, eDP 1.2 without PSR, no camera</p>

**Table 1-1 Product components and their descriptions (continued)**

Category	Description
	250 nits, 45% CG, eDP 1.2 without PSR, HD camera
	250 nits, 45% CG, eDP 1.2 without PSR, HD + IR camera
	250 nits, 45% CG, eDP 1.2 without PSR, HD camera, WWAN models
<b>Memory</b>	Two customer-accessible memory module slots supporting up to 32 GB of RAM
	DDR4-3200 dual-channel support
	Supports the following configurations:
	<ul style="list-style-type: none"> <li>• 32 GB (16 × 2)</li> <li>• 16 GB (8 × 2) or (16 × 1)</li> <li>• 12 GB (8 + 4)</li> <li>• 8 GB (8 × 1 or 4 × 2)</li> <li>• 4 GB (4 × 1)</li> </ul>
<b>Primary storage</b>	<b>M.2 2280 solid-state drives, PCIe, NVMe</b>
	1 TB, PCIe, Gen3 × 4, TLC
	512 GB, PCIe (Gen3 × 2 × 2) + 32 GB Optane™ memory module
	512 GB, PCIe, value
	256 GB, PCIe, value
	128 GB, PCIe, Gen3 × 2, TLC
<b>Audio and video</b>	HP Audio Control
	Stereo speakers (2)
	Microphone (dual-array)
	Camera, HD 720p (select products only)
	Camera, HD 720p + IR (infrared) (select products only)
	Supports WDR (Wide Dynamic Range)
<b>RJ-45 (network) jack</b>	Realtek RTL8111HSH-CG 10/100/1000
	The following support S4/S5 wake on LAN (via out of band) and S0/S3/S4/S5 MPAT (via out of band): HP Docking Station, HP USB-C Mini Dock, HP USB-C/A Universal Dock G2, HP USB-C Dock G5, HP Thunderbolt Dock 120 W G2.
<b>Wireless</b>	<b>Wireless Local Area Network (WLAN)</b> (select products only)
	Intel Wireless-AC 9560 802.11ac 2 × 2 Wi-Fi + Bluetooth® 5 (MU-MIMO supported)
	Intel Wi-Fi 6 AX201 + Bluetooth 5 (non-vPro) (802.11ax 2 × 2, MU-MIMO, supporting gigabit file transfer speeds)
	Realtek RTL8822BE 802.11ac/abgn 2 × 2 + Bluetooth 5 (MU-MIMO supported)
	Compatible with Miracast® devices
	Two WLAN antennas configured at top of panel
	Supports HP Connection Optimizer (with data analytics)

**Table 1-1 Product components and their descriptions (continued)**

<b>Category</b>	<b>Description</b>
	Supports Static BIOS SAR for Intel modules and Realtek modules
	Supports HP Extended Range Wireless LAN
	Supports HP LAN-Wireless Protection (WLAN/LAN/WWAN switching)
	<b>Wireless Wide Area Network (WWAN)</b> (select products only)
	Intel XMM™ 7360 LTE-Advanced (Cat 9)
	WWAN antennas (worldwide 5 band, in WWAN panels)
	WWAN cards are compatible with a programmable removable eSIM
<b>Ports</b>	HDMI 1.4b
	Audio-out (headphone)/audio-in (microphone) combo jack
	(3) USB 3.1 Gen 1 Type-A ports
	USB 3.1 Gen 2 Type-C port
	RJ-45 (network) jack
	AC Smart Pin adapter plug, 4.5 mm
<b>Media card reader</b>	microSD™ memory card reader
<b>Sensors</b>	Hall sensor
	Ambient light sensor
<b>Keyboard/pointing devices</b>	<b>Keyboard</b>
	Backlit, spill resistant
	Not backlit, spill resistant
	Backlit, spill resistant, privacy
	<b>Clickpad</b>
	Firmware PTP
	Microsoft® precision touchpad default gestures support
	No hybrid mode support
<b>Power requirements</b>	<b>Battery</b>
	3 cell, 45 Whr, HP Long Life
	HP Fast Charge Technology
	Supports Modern Standby
	<b>Smart AC adapters</b>
	65 W, 4.5 mm
	65 W, right angle, nPFC, 4.5 mm, 1.8 m (6 ft)
	65 W, 7.4 mm,
	65 W, LC, USB Type-C

**Table 1-1 Product components and their descriptions (continued)**

<b>Category</b>	<b>Description</b>
	65 W, straight, nPFC, USB Type-C, 1.8 m (6 ft)
	65 W, USB Type-C, slim travel adapter
	45 W, 4.5 mm
	45 W, nPFC, right angle
	45 W, 4.5 mm (Japan only)
	45 W, LC, USB Type-C
	45 W, nPFC, USB Type-C, straight
	45 W, nPFC, standard C8 for 2 prong barrel
	<b>Power cord</b>
	C7, 1.0 m (3.3 ft), conventional
	C5, 1.0 m (3.3 ft), conventional
<b>Security</b>	Trusted Platform Module (TPM) 2.0
	Nano cable lock
	Touch fingerprint sensor (select products only)
	HP SureKey Standard/Nano/Wedge Cable Lock
<b>Operating system</b>	Windows® 10 Home 64
	Windows 10 Home 64 Advanced
	Windows 10 Home 64 Advanced Single Language
	Windows 10 Home 64 Chinese Market CPPP
	Windows 10 Home 64 High-End Chinese Market CPPP
	Windows 10 Home 64 Plus
	Windows 10 Home 64 Plus Single Language
	Windows 10 Home 64 Plus Single Language Africa Market PPP
	Windows 10 Home 64 Plus Single Language APAC EM PPP
	Windows 10 Home 64 Plus Single Language India Market PPP
	Windows 10 Home 64 Plus Single Language Indonesia Market PPP
	Windows 10 Home 64 Single Language
	Windows 10 Home 64 Single Language Africa Market PPP
	Windows 10 Home 64 Single Language APAC EM PPP
	Windows 10 Home 64 Single Language India Market PPP
	Windows 10 Home 64 Single Language Indonesia Market PPP
	Windows 10 Home 64 StF MSNA for Higher Education Strategic
	Windows 10 Enterprise 64

**Table 1-1 Product components and their descriptions (continued)**

<b>Category</b>	<b>Description</b>
	Windows 10 Enterprise 64 LTSC 1809 (RS5)
	Windows 10 Pro 64
	Windows 10 Pro CBB 1909
	Windows 10 Pro 64 Chinese Market
	Windows 10 Pro 64 StF MSNA Plus
	Windows 10 Pro 64 StF MSNA Standard
	Windows 10 Pro 64 StF MSNA Strategic
	FreeDOS 3.0
	<b>Restore media</b>
	Windows 10 Professional 64 bit OS DVD
	Windows 10 Professional 64 bit OS USB
	<b>Certified</b>
	Microsoft WHQL
<b>Serviceability</b>	<b>End user replaceable parts</b>
	AC adapter

## 2 Components



Your computer features top-rated components. This chapter provides details about your components, where they are located, and how they work.

### Right

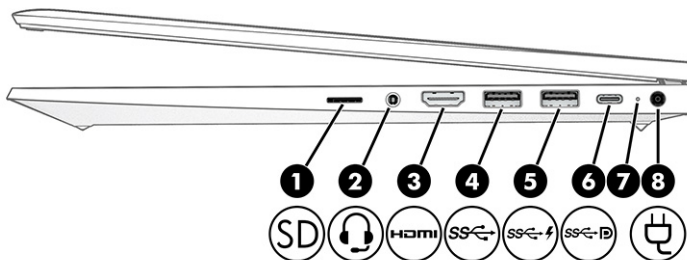



Use the illustration and table to identify the components on the right side of the computer.



**Table 2-1 Right-side components and their descriptions**

Component	Description
<p>(1)  microSD memory card reader</p>	<p>Reads optional memory cards that store, manage, share, or access information.</p> <p>To insert a card:</p> <ol style="list-style-type: none"> <li>1. Hold the card label-side up, with the connectors facing the computer.</li> <li>2. Insert the card into the memory card reader, and then press in on the card until it is firmly seated.</li> </ol> <p>To remove a card:</p> <ul style="list-style-type: none"> <li>▲ Press in on the card, and then remove it from the memory card reader.</li> </ul>
<p>(2)  Audio-out (headphone)/Audio-in (microphone) combo jack</p>	<p>Connects optional powered stereo speakers, headphones, earbuds, a headset, or a television audio cable. Also connects an optional headset microphone. This jack does not support optional standalone microphones.</p> <p><b>WARNING!</b> To reduce the risk of personal injury, adjust the volume before putting on headphones, earbuds, or a headset. For additional safety information, see the <i>Regulatory, Safety, and Environmental Notices</i>.</p> <p>To access this guide:</p> <ul style="list-style-type: none"> <li>▲ Type <b>HP Documentation</b> in the taskbar search box, and then select <b>HP Documentation</b>.</li> </ul> <p><b>NOTE:</b> When a device is connected to the jack, the computer speakers are disabled.</p>

**Table 2-1 Right-side components and their descriptions (continued)**



Component	Description
(3)  HDMI port	Connects an optional video or audio device, such as a high-definition television, any compatible digital or audio component, or a high-speed High Definition Multimedia Interface (HDMI) device.
(4)  USB SuperSpeed port	Connects a USB device, provides high-speed data transfer, and (for select products) charges small devices when the computer is on or in Sleep mode.
(5)  USB SuperSpeed port with HP Sleep and Charge	Connects a USB device, provides high-speed data transfer, and charges small devices, even when the computer is off.
(6)  USB Type-C® power connector port, SuperSpeed port, and DisplayPort™ connector	<p>Connects an AC adapter that has a USB Type-C connector, supplying power to the computer and, if needed, charging the computer battery.</p> <p>– and –</p> <p>Connects a USB device, provides high-speed data transfer, and (for select products) charges small devices when the computer is on or in Sleep mode.</p> <p>– and –</p> <p>Connects a display device that has a USB Type-C connector, providing DisplayPort output.</p> <p><b>NOTE:</b> Cables, adapters, or both (purchased separately) might be required.</p>
(7) Battery light	<p>When AC power is connected:</p> <ul style="list-style-type: none"> <li>• White: The battery charge is greater than 90%.</li> <li>• Amber: The battery charge is from 0 to 90%.</li> <li>• Off: The battery is not charging.</li> </ul> <p>When AC power is disconnected (battery not charging):</p> <ul style="list-style-type: none"> <li>• Blinking amber: The battery has reached a low battery level. When the battery has reached a critical battery level, the battery light begins blinking rapidly.</li> <li>• Off: The battery is not charging.</li> </ul>
(8)  Power connector	Connects an AC adapter.

## Left

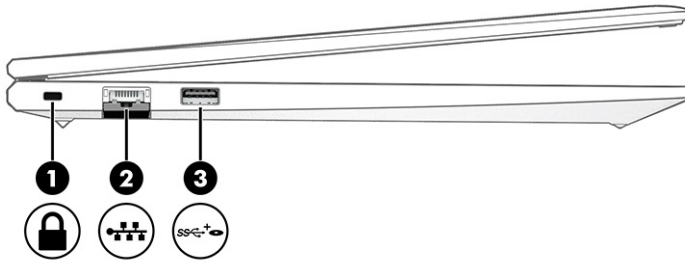
Use the illustration and table to identify the components on the left side of the computer.

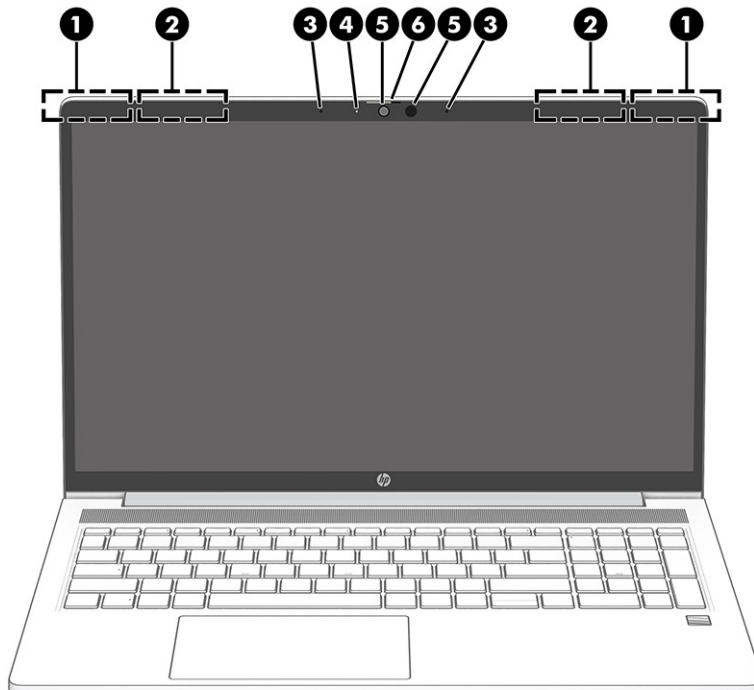

**Table 2-2 Left-side components and their descriptions**

Component	Description
(1) 	Security cable slot Attaches an optional security cable to the computer. <b>NOTE:</b> The security cable is designed to act as a deterrent, but it might not prevent the computer from being mishandled or stolen.
(2) 	RJ-45 (network) jack/status lights Connects a network cable. <ul style="list-style-type: none"> <li>• Green (left): The network is connected.</li> <li>• Amber (right): Activity is occurring on the network.</li> </ul>
(3) 	USB SuperSpeed powered port Connects and supplies power to a USB device, provides high-speed data transfer, and (for select products) charges small devices when the computer is on or in Sleep mode.

## Display

Use the illustration and table to identify the display components.





**Table 2-3 Display components and their descriptions**

Component	Description
(1) WLAN antennas* (select products only)	Send and receive wireless signals to communicate with wireless local area networks (WLANs).
(2) WWAN antennas* (select products only)	Send and receive wireless signals to communicate with wireless wide area networks (WWANs).
(3) Internal microphones	Record sound.
(4) Camera light (select products only)	On: The camera is in use.
(5) Camera(s) (select products only)	Allow(s) you to video chat, record video, and record still images. Some cameras also allow a facial recognition logon to Windows, instead of a password logon. <b>NOTE:</b> Camera functions vary depending on the camera hardware and software installed on your product.
(6) Camera privacy cover (select products only)	By default, the camera lens is uncovered, but you can slide the camera privacy cover to block the camera's view. To use the camera, slide the camera privacy cover in the opposite direction to reveal the lens. <b>NOTE:</b> If you have both front-facing and rear-facing cameras, when one camera lens is revealed and ready to use, the other is concealed.

\*The antennas are not visible from the outside of the computer. For optimal transmission, keep the areas immediately around the antennas free from obstructions.

For wireless regulatory notices, see the section of the *Regulatory, Safety, and Environmental Notices* that applies to your country or region.

To access this guide:

▲ Type `HP Documentation` in the taskbar search box, and then select **HP Documentation**.

## Keyboard area

Keyboards can vary by language.

## Touchpad

The touchpad settings and components are described here.

### Touchpad settings

You learn how to adjust the touchpad settings and components here.

#### Adjusting touchpad settings

Use these steps to adjust touchpad settings and gestures.

1. Type `touchpad settings` in the taskbar search box, and then press [enter](#).
2. Choose a setting.

#### Turning on the touchpad

Follow these steps to turn on the touchpad.

1. Type `touchpad settings` in the taskbar search box, and then press `enter`.
2. Using an external mouse, click the **Touchpad** button.

If you are not using an external mouse, press the `Tab` key repeatedly until the pointer rests on the **touchpad** button. Then press the `spacebar` to select the button.

## Touchpad components

Use the illustration and table to identify the touchpad components.

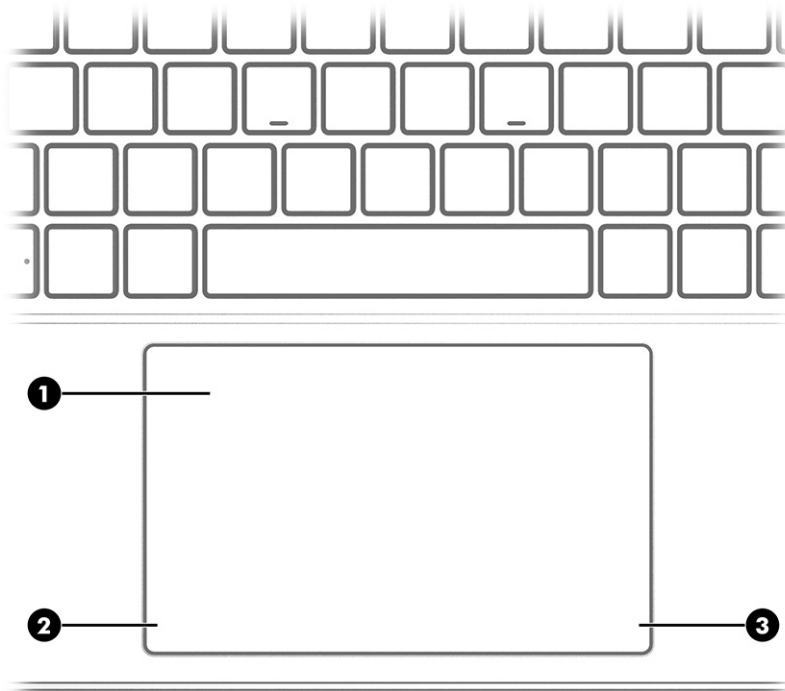
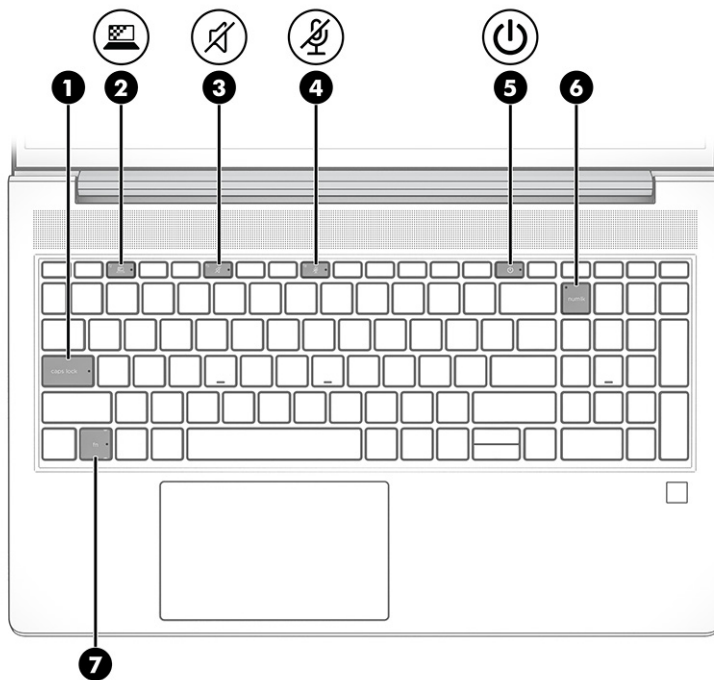

**Table 2-4 Touchpad components and their descriptions**





Component	Description
(1) Touchpad zone	Reads your finger gestures to move the pointer or activate items on the screen.
(2) Left control zone	Textured area that allows you to perform additional gestures.
(3) Right control zone	Textured area that allows you to perform additional gestures.

## Lights

Use the illustration and table to identify the lights on the computer.



**Table 2-5 Lights and their descriptions**

Component	Description
(1) Caps lock light	On: Caps lock is on, which switches the key input to all capital letters.
(2) Privacy key light	On: Privacy screen is on, which helps prevent side-angle viewing.
(3)  Mute light	<ul style="list-style-type: none"> <li>On: Computer sound is off.</li> <li>Off: Computer sound is on.</li> </ul>
(4)  Microphone mute light	<ul style="list-style-type: none"> <li>On: Microphone is off.</li> <li>Off: Microphone is on.</li> </ul>
(5)  Power light	<ul style="list-style-type: none"> <li>On: The computer is on.</li> <li>Blinking (select products only): The computer is in the Sleep state, a power-saving state. The computer shuts off power to the display and other unnecessary components.</li> <li>Off: Depending on your computer model, the computer is off, in Hibernation, or in Sleep. Hibernation is the power-saving state that uses the least amount of power.</li> </ul>
(6)  Num Lk light	On: Num Lk is on.
(7) Fn lock light	On: The <b>fn</b> key is locked. For more information, see <a href="#">Hot keys (select products only) on page 14</a> .



## Button, speakers, and fingerprint reader

Fingerprint readers can be located on the touchpad, on a side panel of the computer, or on the top cover below the keyboard.

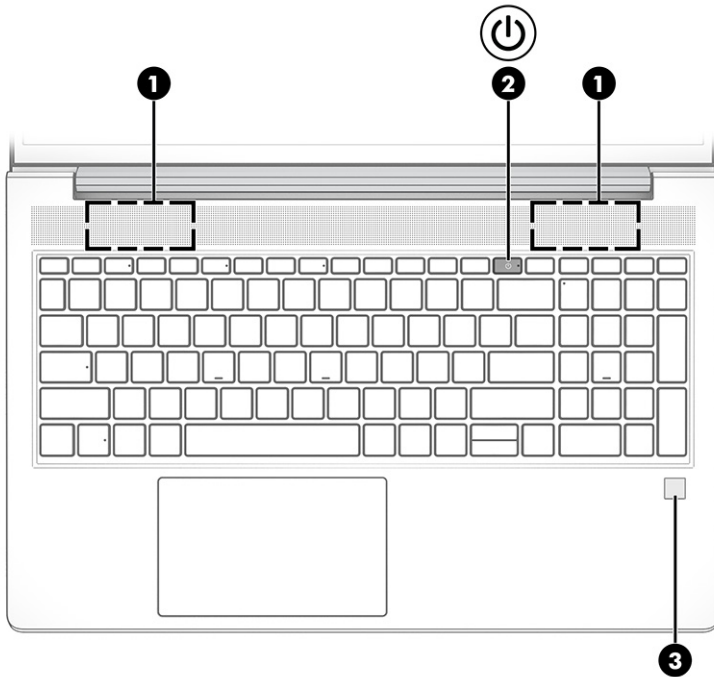
**IMPORTANT:** To verify that your computer supports fingerprint reader sign-in, type *Sign-in options* in the taskbar search box and follow the on-screen instructions. If **Fingerprint reader** is not listed as an option, then your notebook does not include a fingerprint reader.



**Table 2-6 Button, speakers, and fingerprint reader and their descriptions**

Component	Description
(1) Speakers	Produce sound.
(2)  Power button	<ul style="list-style-type: none"> <li>When the computer is off, press the button briefly to turn on the computer.</li> <li>When the computer is on, press the button briefly to initiate Sleep.</li> <li>When the computer is in the Sleep state, press the button briefly to exit Sleep (select products only).</li> <li>When the computer is in Hibernation, press the button briefly to exit Hibernation.</li> </ul> <p><b>IMPORTANT:</b> Pressing and holding down the power button results in the loss of unsaved information.</p> <p>If the computer has stopped responding and shutdown procedures are ineffective, press and hold the power button for at least 4 seconds to turn off the computer.</p> <p>To learn more about your power settings, see your power options.</p> <p>▲ Right-click the <b>Power meter</b> icon  and then select <b>Power Options</b>.</p>
(3) Fingerprint reader (select products only)	<p>Allows a fingerprint logon to Windows, instead of a password logon.</p> <p>▲ Touch your finger to the fingerprint reader.</p>

**Table 2-6 Button, speakers, and fingerprint reader and their descriptions (continued)**



Component	Description
	<b>IMPORTANT:</b> To prevent fingerprint logon issues, make sure when you register your fingerprint that all sides of your finger are registered by the fingerprint reader.

## Special keys

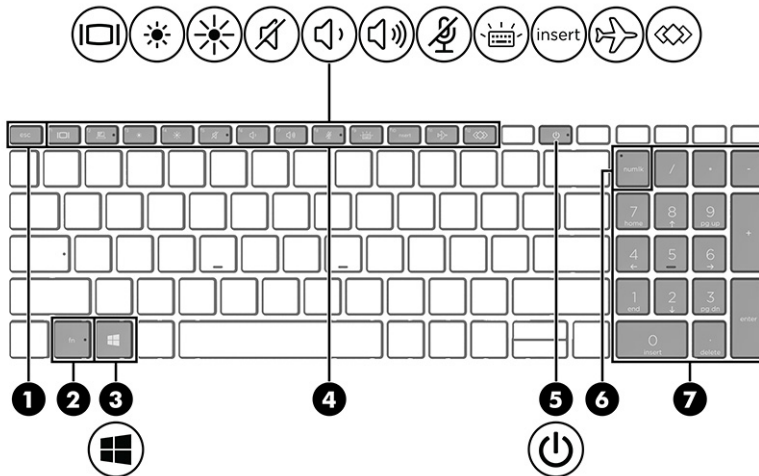
Use the illustration and table to identify the special keys.



**Table 2-7 Special keys and their descriptions**

Component	Description
(1) <code>esc</code> key	Displays system information when pressed in combination with the <code>fn</code> key.
(2) <code>fn</code> key	Executes frequently used system functions when pressed in combination with another key. Such key combinations are called <i>hot keys</i> . See <a href="#">Hot keys (select products only) on page 14</a> .
(3)  Windows key	Opens the Start menu. <b>NOTE:</b> Pressing the Windows key again will close the Start menu.
(4) Action keys	Execute frequently used system functions.
(5)  Power button	<ul style="list-style-type: none"> <li>When the computer is off, press the button briefly to turn on the computer.</li> <li>When the computer is on, press the button briefly to initiate Sleep.</li> <li>When the computer is in the Sleep state, press the button briefly to exit Sleep (select products only).</li> <li>When the computer is in Hibernation, press the button briefly to exit Hibernation.</li> </ul> <b>IMPORTANT:</b> Pressing and holding down the power button results in the loss of unsaved information.

**Table 2-7 Special keys and their descriptions (continued)**

Component	Description
	<p>If the computer has stopped responding and shutdown procedures are ineffective, press and hold the power button for at least 4 seconds to turn off the computer.</p> <p>To learn more about your power settings, see your power options.</p> <p>▲ Right-click the <b>Power meter</b> icon  and then select <b>Power Options</b>.</p>
(6) num lk key	<p>Turns the embedded numeric keypad on and off when pressed in combination with the <b>fn</b> key.</p> <p>– or –</p> <p>Turns the embedded numeric keypad on and off.</p> <p>– or –</p> <p>Alternates between the navigational and numeric functions on the integrated numeric keypad.</p>
(7) Integrated numeric keypad	<p>A separate keypad to the right of the alphabet keyboard. When <b>num lk</b> is pressed, the integrated keypad can be used like an external numeric keypad.</p> <p><b>NOTE:</b> If the keypad function is active when the computer is turned off, that function is reinstated when the computer is turned back on.</p>

## Hot keys (select products only)

A hot key is the combination of the **fn** key and another key. Use the table to identify the hot keys.

To use a hot key:

- ▲ Press the **fn** key, and then press one of the keys listed in the following table.

**Table 2-8 Hot keys and their descriptions**

Key	Description
C	Turns on scroll lock.
E	Turns on the insert function.
R	Breaks the operation.
S	Sends a programing query.
W	Pauses the operation.

## Bottom

Use the illustration and table to identify the bottom component.

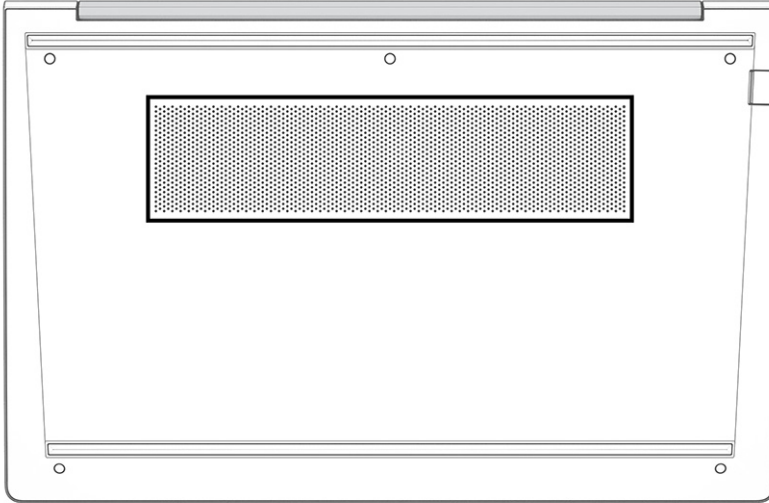

**Table 2-9 Bottom component and its description**

Component	Description
Vent	Enables airflow to cool internal components. <b>NOTE:</b> The computer fan starts up automatically to cool internal components and prevent overheating. It is normal for the internal fan to cycle on and off during routine operation.

## Rear

Use the illustration and table to identify the rear component.



**Table 2-10 Rear component and its description**

Component	Description
Vent	Enables airflow to cool internal components. <b>NOTE:</b> The computer fan starts up automatically to cool internal components and prevent overheating. It is normal for the internal fan to cycle on and off during routine operation.

## Labels

The labels affixed to the computer provide information you might need when you troubleshoot system problems or travel internationally with the computer. Labels might be in paper form or imprinted on the product.

 **IMPORTANT:** Check the following locations for the labels described in this section: the bottom of the computer, inside the battery bay, under the service door, on the back of the display, or on the bottom of a tablet kickstand.

- Service label—Provides important information to identify your computer. When contacting support, you might be asked for the serial number, the product number, or the model number. Locate this information before you contact support.

Your service label will resemble one of these examples. Refer to the illustration that most closely matches the service label on your computer.

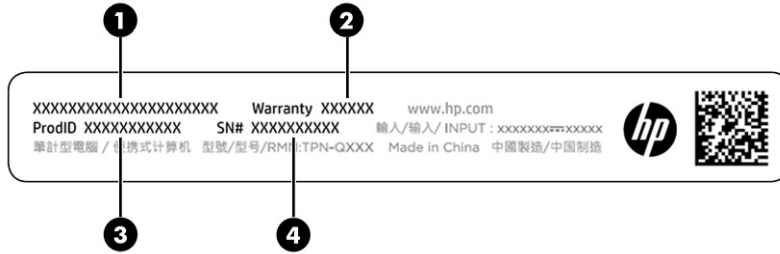

**Table 2-11 Service label components**

Component	
(1)	HP product name
(2)	Warranty period
(3)	Product ID
(4)	Serial number

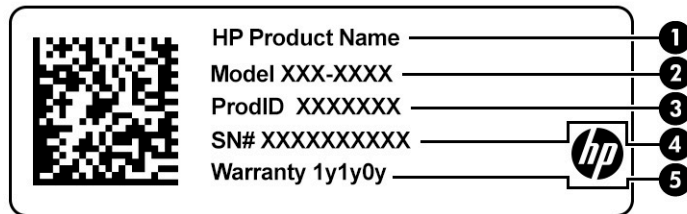

**Table 2-12 Service label components**

Component	
(1)	HP product name
(2)	Model number
(3)	Product ID
(4)	Serial number
(5)	Warranty period



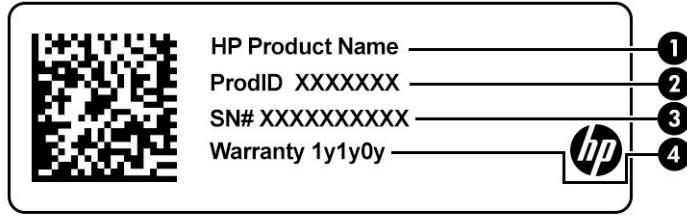

**Table 2-13 Service label components**

Component	
(1)	HP product name
(2)	Product ID
(3)	Serial number
(4)	Warranty period

- Regulatory labels—Provide regulatory information about the computer.
- Wireless certification labels—Provide information about optional wireless devices and the approval markings for the countries or regions in which the devices have been approved for use.

# 3 Illustrated parts catalog

Use this table to determine the spare parts that are available for the computer.

## Computer major components

To identify the computer major components, use this illustration and table.

**NOTE:** HP continually improves and changes product parts. For complete and current information about supported parts for your computer, go to <http://partsurfer.hp.com>, select your country or region, and then follow the on-screen instructions.

**NOTE:** Details about your computer, including model, serial number, product key, and length of warranty, are on the service tag at the bottom of your computer.

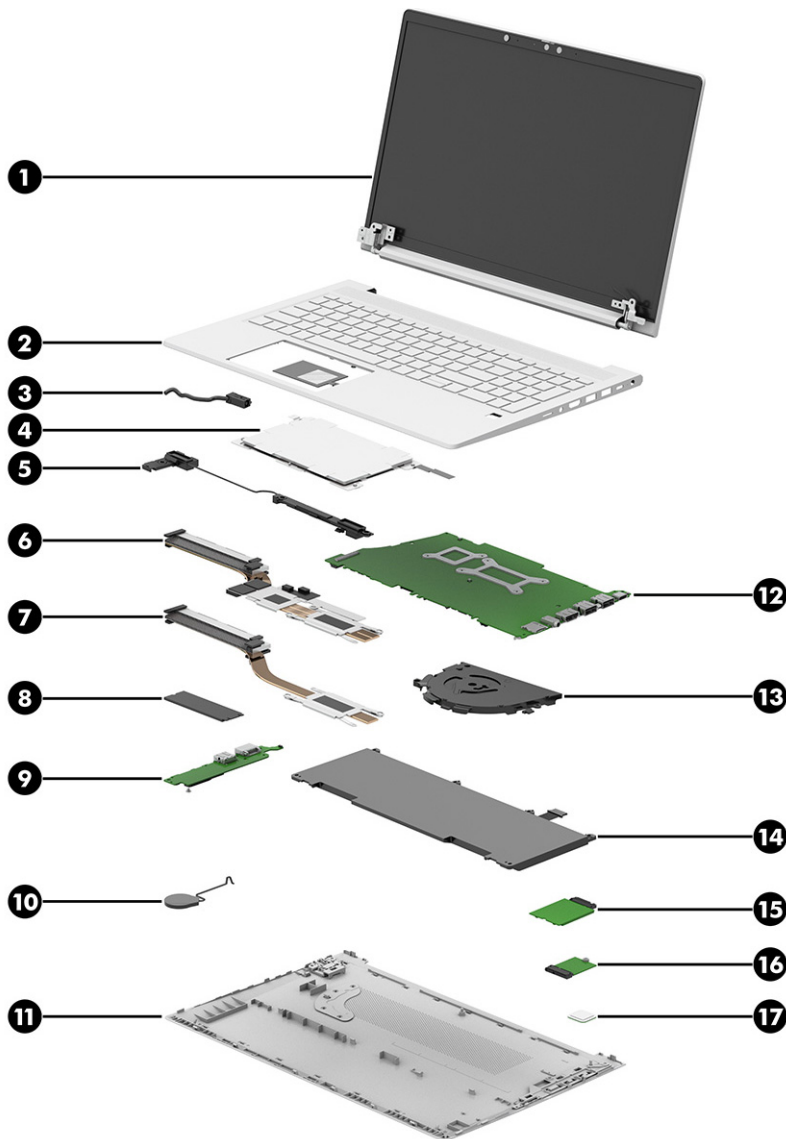

**Table 3-1 Computer major component descriptions and part numbers**

Item	Component	Spare part number
(1)	<b>Display assembly</b> <b>NOTE:</b> Display spare parts are available only as subcomponents. For spare part information, see <a href="#">Display assembly subcomponents on page 20</a> .	not available as a spare part
(2)	<b>Top cover/keyboard</b> <b>NOTE:</b> For a detailed list of country codes, see <a href="#">Top cover with keyboard on page 57</a> .	
	Not backlit	M21740-xx1
	Backlit, for use in privacy models	M21741-xx1
	Backlit	M21742-xx1
(3)	<b>Power connector cable</b>	M21725-001
(4)	<b>Touchpad</b> <b>NOTE:</b> The touchpad cable is available in the Cable Kit as spare part number M21713-001.	M21999-001
(5)	<b>Speaker</b>	M21723-001
	<b>Heat sink</b> (includes replacement thermal material)	
(6)	Discrete graphics models	M21717-001
(7)	UMA graphics models	M21716-001
(8)	<b>Solid-state drive</b>	
	1 TB, PCIe, TLC	L85348-002
	1 TB, locked	M31024-001
	512 GB, PCIe, value	L85364-002
	512 GB solid-state drive + 32 GB Optane memory	L85366-002
	256 GB, PCIe, value	L85354-002
	128 GB, PCIe, TLC	M06792-002
(9)	<b>I/O board</b> (includes cable) <b>NOTE:</b> The I/O board cables are available in the Cable Kit as spare part number M21713-001. The RJ-45 door is available in the Plastics Kit as spare part number M21714-001.	M21712-001
(10)	<b>RTC battery</b>	M34737-001
(11)	<b>Bottom cover</b>	
	For use in models with discrete graphics memory	M21721-001
	For use in models with UMA graphics memory	M21720-001
(12)	<b>System board</b> (includes integrated processor) <b>NOTE:</b> All system board spare part kits include replacement thermal material. All system boards use the following part numbers: xxxxxx-001: Non-Windows operating systems xxxxxx-601: Windows operating system	
	For use in models with discrete graphics	

**Table 3-1 Computer major component descriptions and part numbers (continued)**

Item	Component	Spare part number
	<ul style="list-style-type: none"> <li>Intel Core i7-1185G7 processor</li> </ul>	M21690-xx1
	<ul style="list-style-type: none"> <li>Intel Core i7-1165G7 processor</li> </ul>	M21692-xx1
	<ul style="list-style-type: none"> <li>Intel Core i5-1145G7 processor</li> </ul>	M21686-xx1
	<ul style="list-style-type: none"> <li>Intel Core i5-1135G7 processor</li> </ul>	M21688-xx1
	<ul style="list-style-type: none"> <li>Intel Core i3-1115G4 processor</li> </ul>	M21684-xx1
	For use in models with UMA graphics	
	<ul style="list-style-type: none"> <li>Intel Core i7-1185G7 processor</li> </ul>	M21706-xx1
	<ul style="list-style-type: none"> <li>Intel Core i7-1165G7 processor</li> </ul>	M21708-xx1
	<ul style="list-style-type: none"> <li>Intel Core i5-1135G7 processor</li> </ul>	M21702-xx1
	<ul style="list-style-type: none"> <li>Intel Core i5-1135G7 processor (WWAN models)</li> </ul>	M21704-xx1
	<ul style="list-style-type: none"> <li>Intel Core i3-1115G4 processor</li> </ul>	M21696-xx1
	<ul style="list-style-type: none"> <li>Intel Core i3-1115G4 processor (WWAN models)</li> </ul>	M21698-xx1
<b>(13)</b>	<b>Fan</b>	
	For use in models with discrete graphics	M21719-001
	For use in models with UMA graphics	M21718-001
<b>(14)</b>	<b>Battery</b> (3 cell, 45 Whr)	M02027-002
<b>(15)</b>	<b>WWAN module</b> (Intel XMM 7360 LTE-Advanced (Cat 9))	L70670-002
<b>(16)</b>	<b>WLAN module</b>	
	Intel Wi-Fi 6 AX201 + Bluetooth 5 (non-vPro)	L92724-002
	Intel Wireless-AC 9560 802.11ac 2 × 2 Wi-Fi + Bluetooth 5 (MU-MIMO supported)	L22634-002
	Realtek RTL8822BE 802.11ac/abgn 2 × 2 + Bluetooth 5 (MU-MIMO supported)	L44796-002
<b>(17)</b>	<b>Fingerprint reader</b> (includes conductive tape)	M21724-001
	<b>NOTE:</b> The fingerprint reader cable is available in the Cable Kit as spare part number M21713-001. The fingerprint reader bracket is available in the Bracket Kit as spare part number M21715-001.	
	<b>Memory modules</b> (DDR4, PC-3200; not illustrated)	
	16 GB	L67710-002
	8 GB	L46598-002
	4 GB	L83673-002

## Display assembly subcomponents

To identify the display assembly subcomponents, use this illustration and table.

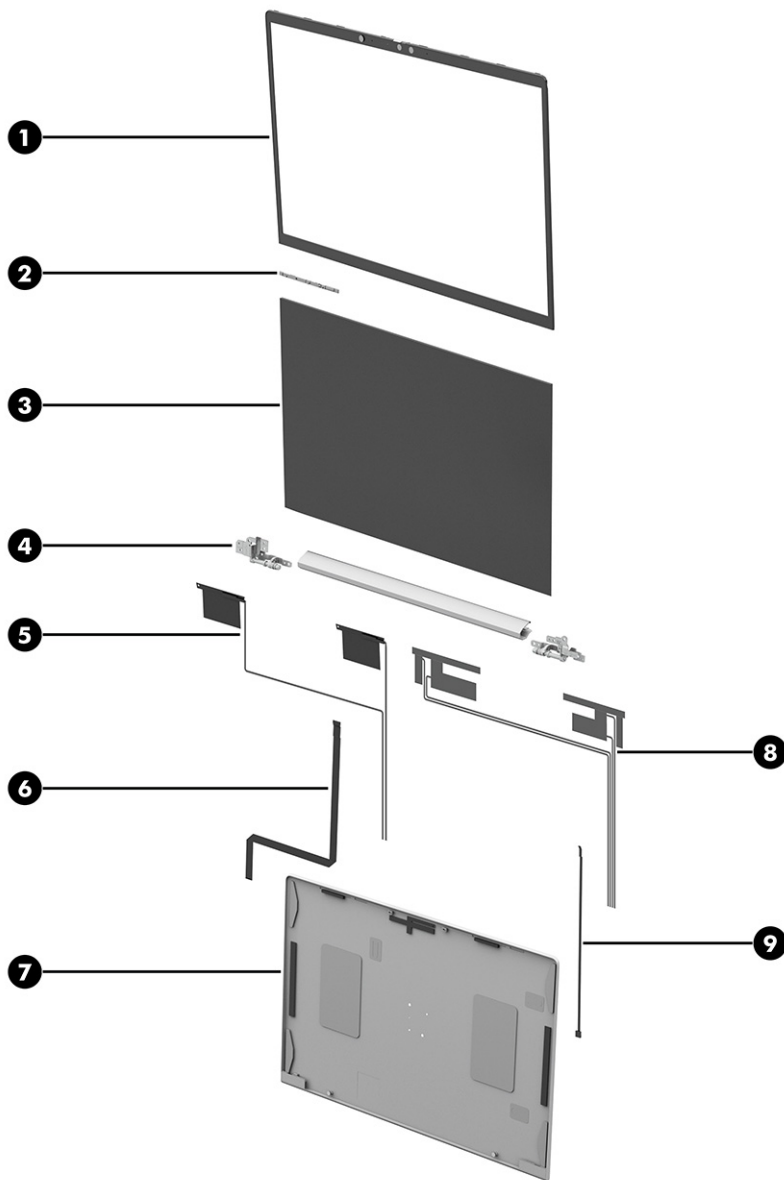

**Table 3-2 Display component descriptions and part numbers**

Item	Component	Spare part number
<b>(1)</b>	<b>Display bezel</b>	
	For use in models without a camera	M21991-001
	For use in models with an HD camera	M21992-001
	For use in models with an HD + IR camera	M21993-001
<b>(2)</b>	<b>Camera module</b> (includes camera adhesive, display panel adhesive and bezel adhesive)	
	HD camera	M29583-001
	IR camera	M27889-001
	<b>Microphone module</b> (for use in models without a camera module; includes display panel adhesive and bezel adhesive)	M27888-001

**Table 3-2 Display component descriptions and part numbers (continued)**

Item	Component	Spare part number
<b>(3)</b>	<b>Display panel</b> (includes display panel adhesive and bezel adhesive)	
	FHD, privacy, 1000 nits	M21739-001
	FHD, 400 nits	M22541-001
	FHD, 400 nits, locked	M31023-001
	HD, SVA, 250 nits	M21736-001
	FHD, UWVA, 250 nits	M21737-001
	FHD, UWVA, 250 nits, Touch-on Panel (TOP)	M21738-001
	FHD, UWVA, 250 nits, locked	M31021-001
	<b>LCD Support Kit</b> (includes display panel adhesive and bezel adhesive; not illustrated)	M23560-001
<b>(4)</b>	<b>Hinges</b> (left and right; includes bezel trim pieces, bezel trim protective shielding, display panel adhesive, and bezel adhesive)	M21732-001
<b>(5)</b>	<b>WLAN antennas and cables</b> (includes display panel adhesive and bezel adhesive)	M21727-001
<b>(6)</b>	<b>Display/camera cable</b> (includes display panel adhesive and bezel adhesive)	M21733-001
<b>(7)</b>	<b>Display back cover</b> (includes bezel adhesive)	
	Models with a 250 nit display panel, WLAN, no WWAN	M21987-001
	Models with a 250 nit display panel, WLAN, and WWAN	M21988-001
	Models with a 400 nit display panel, WLAN	M21989-001
<b>(8)</b>	<b>WWAN antennas and cables</b> (includes display panel adhesive and bezel adhesive)	M21728-001
<b>(9)</b>	<b>WWAN cable</b> (included in the LCD cable kit)	M21733-001

## Cable Kit

To identify the contents of the Cable Kit, use this table.

**Table 3-3 Cable Kit content descriptions and part number**

Component	Spare part number
<b>Cable Kit</b> , includes:	M21713-001
I/O board cable	
I/O board cable (USB 3.0)	
Touchpad cable	
Fingerprint reader board cable	

## Miscellaneous parts

To identify the miscellaneous parts, use this table.

**Table 3-4 Miscellaneous part descriptions and part numbers**

<b>Component</b>	<b>Spare part number</b>
<b>AC adapters</b>	
65 W, nPFC, SMART, 4.5 mm, EM	913691-850
65 W, nPFC, SMART, 3 pin, 4.5 mm	710412-001
65 W, nPFC, USB-C, 1.8 m (6 ft)	L67440-001
65 W, nPFC, USB Type-C, travel adapter	L21487-001
45 W, nPFC, SMART, RC, 4.5 mm, nonslim	741727-001
45 W, nPFC, SMART, RC, 4.5 mm, 2 pin	742436-001
45 W, nPFC, USB-C, 3 pin	934739-850
45 W, nPFC, USB Type-C, 1.8 m (6 ft), 3. pin	L43407-001
<b>Metal top weight</b>	M21726-001
<b>Screw Kit</b>	M21734-001
<b>Plastics Kit</b> (includes smart card insert, SIM card insert, RJ-45 door, and cable holder)	M21714-001
<b>Rubber Kit</b> (includes microphone rubber with mesh, conductive base tape, and memory module protective shielding)	M21394-001
<b>Power cord (C7, conventional, 1.0 m [3.3 ft])</b>	
Japan	L19375-001
<b>Power adapter, duckhead</b>	
Japan	L33157-001
<b>Power cord (C5, premium, 1.0 m [3.3 ft])</b>	
People's Republic of China	920689-014
<b>Power cord (C5, conventional, 1.0 m [3.3 ft])</b>	
Argentina	L19357-001
Australia	L19358-001
Denmark	L19360-001
Europe (Austria, Belgium, Finland, France, Germany, the Netherlands, Norway, and Sweden)	L19361-001
India	L19363-001
Israel	L19362-001
Italy	L19364-001
Japan	L19365-001
North America	L19367-001
People's Republic of China	L19368-001
South Africa	L19369-001
South Korea	L19366-001
Switzerland	L19370-001

**Table 3-4 Miscellaneous part descriptions and part numbers (continued)**

<b>Component</b>	<b>Spare part number</b>
Taiwan	L19372-001
Thailand	L19371-001
The United Kingdom	L19373-001
<b>Power cord (C5, conventional, 1.8 m [6 ft])</b>	
Argentina	L19357-002
Australia	L19358-002
Denmark	L19360-002
Europe (Austria, Belgium, Finland, France, Germany, the Netherlands, Norway, and Sweden)	L19361-002
India	L19363-002
Israel	L19362-002
Italy	L19364-002
Japan	L19365-002
North America	L19367-002
People's Republic of China	L19368-002
South Africa	L19369-002
South Korea	L19366-002
Switzerland	L19370-002
Taiwan	L19372-002
Thailand	L19371-002
The United Kingdom	L19373-002
People's Republic of China	L19368-001



---

## 4 Removal and replacement procedures preliminary requirements

Use this information to properly prepare to disassemble and reassemble the computer.

### Tools required

You need the following tools to complete the removal and replacement procedures:

- Tweezers
- Nonconductive, nonmarking pry tool
- Magnetic Phillips P1 screwdriver

### Service considerations

The following sections include some of the considerations that you must keep in mind during disassembly and assembly procedures.

---

 **NOTE:** As you remove each subassembly from the computer, place the subassembly (and all accompanying screws) away from the work area to prevent damage.

---

### Plastic parts

Using excessive force during disassembly and reassembly can damage plastic parts.

### Cables and connectors

Handle cables with extreme care to avoid damage.

---

 **IMPORTANT:** When servicing the computer, be sure that cables are placed in their proper locations during the reassembly process. Improper cable placement can damage the computer.

---

Apply only the tension required to unseat or seat the cables during removal and insertion. Handle cables by the connector whenever possible. In all cases, avoid bending, twisting, or tearing cables. Be sure that cables are routed so that they cannot be caught or snagged as you remove or replace parts. Handle flex cables with extreme care; these cables tear easily.

### Drive handling

Note the following guidelines when handling drives.



---

**IMPORTANT:** Drives are fragile components. Handle them with care. To prevent damage to the computer, damage to a drive, or loss of information, observe these precautions:

Before removing or inserting a hard drive, shut down the computer. If you are unsure whether the computer is off or in Hibernation, turn the computer on, and then shut it down through the operating system.

Before handling a drive, be sure that you are discharged of static electricity. While handling a drive, avoid touching the connector.

Before removing an optical drive, be sure that a disc is not in the drive, and be sure that the optical drive tray is closed.

Handle drives on surfaces covered with at least 2.54 cm (1 inch) of shock-proof foam.

Avoid dropping drives from any height onto any surface.

After removing a hard drive or an optical drive, place it in a static-proof bag.

Avoid exposing an internal hard drive to products that have magnetic fields, such as monitors or speakers.

Avoid exposing a drive to temperature extremes or liquids.

If a drive must be mailed, place the drive in a bubble pack mailer or other suitable form of protective packaging, and label the package “FRAGILE.”

---

## Workstation guidelines

Follow these grounding workstation guidelines:

- Cover the workstation with approved static-shielding material.
- Use a wrist strap connected to a properly grounded work surface and use properly grounded tools and equipment.
- Use conductive field service tools, such as cutters, screw drivers, and vacuums.
- When fixtures must directly contact dissipative surfaces, use fixtures made only of static-safe materials.
- Keep the work area free of nonconductive materials, such as ordinary plastic assembly aids and polystyrene foam.
- Handle ESD-sensitive components, parts, and assemblies by the case or PCM laminate. Handle these items only at static-free workstations.
- Avoid contact with pins, leads, or circuitry.
- Turn off power and input signals before inserting or removing connectors or test equipment.

## Electrostatic discharge information

A sudden discharge of static electricity from your finger or other conductor can destroy static-sensitive devices or microcircuitry. Often the spark is neither felt nor heard, but damage occurs. An electronic device exposed to electrostatic discharge (ESD) might not appear to be affected at all and can work perfectly throughout a normal cycle. The device might function normally for a while, but it has been degraded in the internal layers, reducing its life expectancy.

Networks built into many integrated circuits provide some protection, but in many cases, the discharge contains enough power to alter device parameters or melt silicon junctions.



**IMPORTANT:** To prevent damage to the device when you remove or install internal components, observe these precautions:

Keep components in their electrostatic-safe containers until you are ready to install them.

Before touching an electronic component, discharge static electricity by using the guidelines described [Personal grounding methods and equipment on page 28](#).

Avoid touching pins, leads, and circuitry. Handle electronic components as little as possible.

If you remove a component, place it in an electrostatic-safe container.

## Generating static electricity

Follow these static electricity guidelines.

- Different activities generate different amounts of static electricity.
- Static electricity increases as humidity decreases.

**Table 4-1 Static electricity occurrence based on activity and humidity**

Event	Relative humidity		
	55%	40%	10%
Walking across carpet	7,500 V	15,000 V	35,000 V
Walking across vinyl floor	3,000 V	5,000 V	12,000 V
Motions of bench worker	400 V	800 V	6,000 V
Removing DIPs (dual in-line packages) from plastic tube	400 V	700 V	2,000 V
Removing DIPs from vinyl tray	2,000 V	4,000 V	11,500 V
Removing DIPs from polystyrene foam	3,500 V	5,000 V	14,500 V
Removing bubble pack from PCB (printed circuit board)	7,000 V	20,000 V	26,500 V
Packing PCBs in foam-lined box	5,000 V	11,000 V	21,000 V

Multiple electric components can be packaged together in plastic tubes, trays, or polystyrene foam.



**NOTE:** As little as 700 V can degrade a product.

## Preventing electrostatic damage to equipment

Many electronic components are sensitive to ESD. Circuitry design and structure determine the degree of sensitivity. The following packaging and grounding precautions are necessary to prevent static electricity damage to electronic components.

- To avoid hand contact, transport products in static-safe containers such as tubes, bags, or boxes.
- Protect all electrostatic parts and assemblies with conductive or approved containers or packaging.
- Keep electrostatic-sensitive parts in their containers until they arrive at static-free stations.
- Place items on a grounded surface before removing them from their container.
- Always be properly grounded when touching a sensitive component or assembly.

- Avoid contact with pins, leads, or circuitry.
- Place reusable electrostatic-sensitive parts from assemblies in protective packaging or conductive foam.

## Personal grounding methods and equipment

Using certain equipment can prevent static electricity damage to electronic components.

- **Wrist straps** are flexible straps with a maximum of  $1\text{ M}\Omega \pm 10\%$  resistance in the ground cords. To provide proper ground, a strap must be worn snug against bare skin. The ground cord must be connected and fit snugly into the banana plug connector on the grounding mat or workstation.
- **Heel straps/Toe straps/Boot straps** can be used at standing workstations and are compatible with most types of shoes or boots. On conductive floors or dissipative floor mats, use them on both feet with a maximum of  $1\text{ M}\Omega \pm 10\%$  resistance between the operator and ground.

**Table 4-2 Static shielding protection levels**

Static shielding protection levels	
Method	Voltage
Antistatic plastic	1,500
Carbon-loaded plastic	7,500
Metallized laminate	15,000

## Grounding the work area

To prevent static damage at the work area, follow these precautions.

- Cover the work surface with approved static-dissipative material. Provide a wrist strap connected to the work surface and properly grounded tools and equipment.
- Use static-dissipative mats, foot straps, or air ionizers to give added protection.
- Handle electrostatic sensitive components, parts, and assemblies by the case or PCB laminate. Handle them only at static-free work areas.
- Turn off power and input signals before inserting and removing connectors or test equipment.
- Use fixtures made of static-safe materials when fixtures must directly contact dissipative surfaces.
- Keep work area free of nonconductive materials such as ordinary plastic assembly aids and polystyrene foam.
- Use field service tools, such as cutters, screwdrivers, and vacuums, that are conductive.

## Recommended materials and equipment

HP recommends certain materials and equipment to prevent static electricity.

- Antistatic tape
- Antistatic smocks, aprons, or sleeve protectors
- Conductive bins and other assembly or soldering aids
- Conductive foam
- Conductive tabletop workstations with ground cord of  $1\text{ M}\Omega \pm 10\%$  resistance

- Static-dissipative table or floor mats with hard tie to ground
- Field service kits
- Static awareness labels
- Wrist straps and footwear straps providing 1 M $\Omega$   $\pm$ 10% resistance
- Material handling packages
- Conductive plastic bags
- Conductive plastic tubes
- Conductive tote boxes
- Opaque shielding bags
- Transparent metallized shielding bags
- Transparent shielding tubes

## Packaging and transporting guidelines

Follow these grounding guidelines when packaging and transporting equipment.

- To avoid hand contact, transport products in static-safe tubes, bags, or boxes.
- Protect ESD-sensitive parts and assemblies with conductive or approved containers or packaging.
- Keep ESD-sensitive parts in their containers until the parts arrive at static-free workstations.
- Place items on a grounded surface before removing items from their containers.
- Always be properly grounded when touching a component or assembly.
- Store reusable ESD-sensitive parts from assemblies in protective packaging or nonconductive foam.
- Use transporters and conveyors made of antistatic belts and roller bushings. Be sure that mechanized equipment used for moving materials is wired to ground and that proper materials are selected to avoid static charging. When grounding is not possible, use an ionizer to dissipate electric charges.

# 5 Removal and replacement procedures for authorized service provider parts

This chapter provides removal and replacement procedures for authorized service provider parts.

 **IMPORTANT:** Components described in this chapter should be accessed only by an authorized service provider. Accessing these parts can damage the computer or void the warranty.

 **NOTE:** Details about your computer, including model, serial number, product key, and length of warranty, are on the service tag at the bottom of your computer.

## Component replacement procedures

To remove and replace computer components, use these procedures.

 **NOTE:** HP continually improves and changes product parts. For complete and current information about supported parts for your computer, go to <http://partsurfer.hp.com>, select your country or region, and then follow the on-screen instructions.

You must remove, replace, or loosen as many as 55 screws when you service the parts described in this chapter. Make special note of each screw size and location during removal and replacement.

## Preparation for disassembly

To remove and replace computer components, use these procedures.

See [Removal and replacement procedures preliminary requirements on page 25](#) for initial safety procedures.

1. Turn off the computer. If you are unsure whether the computer is off or in Hibernation, turn the computer on, and then shut it down through the operating system.
2. Disconnect the power from the computer by unplugging the power cord from the computer.
3. Disconnect all external devices from the computer.

## Bottom cover

To remove the bottom cover, use this procedure and illustration.

**Table 5-1 Bottom cover description and part number**

Description	Spare part number
Bottom cover for use in models with discrete graphics memory	M21721-001
Bottom cover for use in models with UMA graphics memory	M21720-001

Before removing the bottom cover, prepare the computer for disassembly ([Preparation for disassembly on page 30](#)).

Remove the bottom cover:

1. Loosen the three captive Phillips screws **(1)** and remove the two Phillips M2.0 × 4.0 screws **(2)** that secure the bottom cover to the computer.

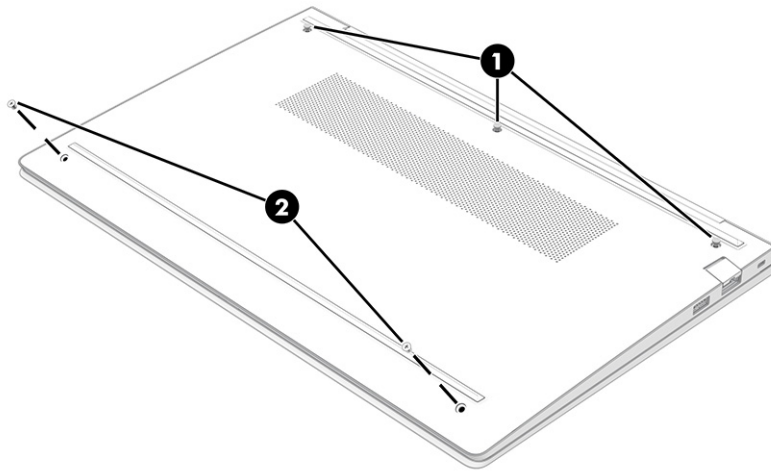

2. Starting near the hinges, use a nonmarking, nonconductive tool to release the edges of the bottom cover from the computer **(1)**.
3. Remove the bottom cover from the computer **(2)**.

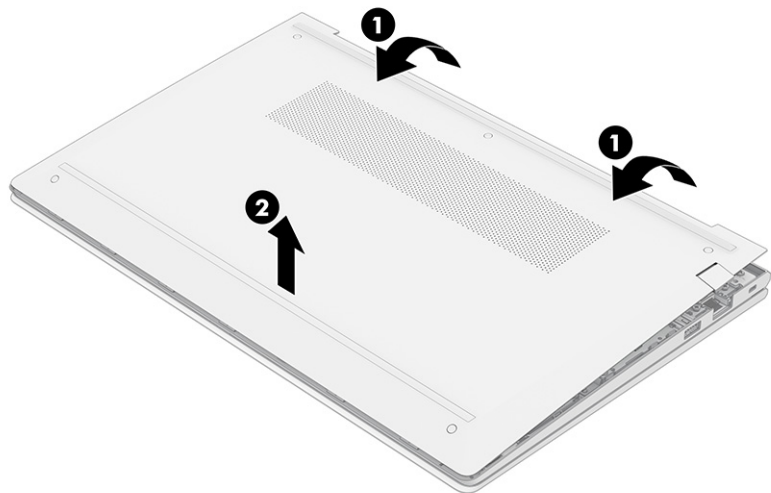

To replace the bottom cover, reverse the removal procedures.

## Battery

To remove the battery, use this procedure and illustration.

**Table 5-2 Battery description and part number**

Description	Spare part number
Battery, 3 cell, 45 Whr	M02027-002

 **WARNING!** To avoid personal injury and damage to the product:

- Do *not* puncture, twist, or crack the battery.
- Do *not* cause an external puncture or rupture to the battery. They can cause a short inside the battery, which can result in battery thermal runaway.
- Do *not* handle or touch the battery enclosure with sharp objects such as tweezers or pliers, which might puncture the battery.
- Do *not* compress or squeeze the battery case with tools or heavy objects stacked on top of the case. These actions can apply undue force on the battery.
- Do *not* touch the connectors with any metallic surface or object, such as metal tools, screws, or coins, which can cause shorting across the connectors.

Before removing the battery, follow these steps:

1. Prepare the computer for disassembly ([Preparation for disassembly on page 30](#)).
2. Remove the bottom cover ([Bottom cover on page 30](#)).

 **WARNING!** To reduce potential safety issues, use only the user-replaceable battery provided with the computer, a replacement battery provided by HP, or a compatible battery purchased from HP.

 **IMPORTANT:** Removing a battery that is the sole power source for the computer can cause loss of information. To prevent loss of information, save your work or shut down the computer through Windows before you remove the battery.

Remove the battery:

1. Disconnect the battery cable from the system board **(1)**.
2. Remove the six Phillips M2.0 × 4.0 screws **(2)** that secure the battery to the computer.



3. Remove the battery from the computer (3).

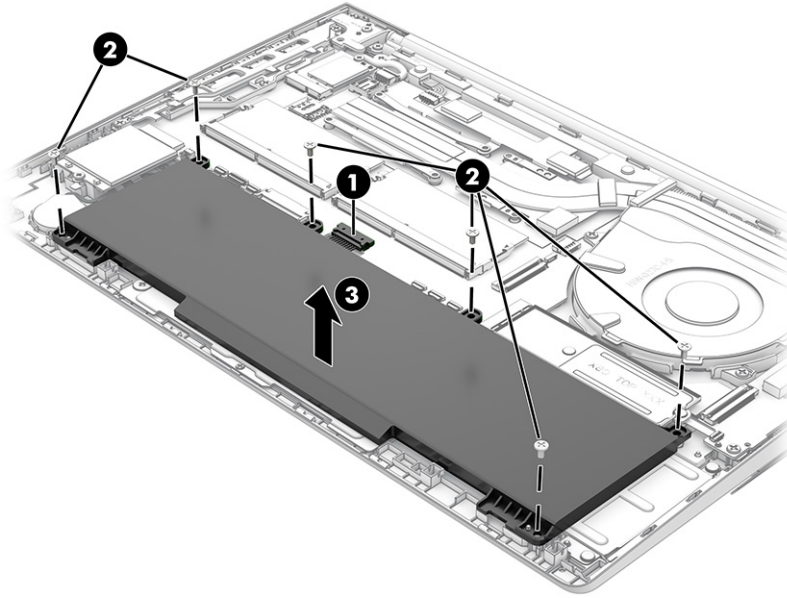

To insert the battery, reverse the removal procedures.

## Memory modules

To remove the memory modules, use this procedure and illustration.

**Table 5-3** Memory module descriptions and part numbers

Description	Spare part number
16 GB, DDR4-3200	L67710-002
8 GB, DDR4-3200	L46598-002
4 GB, DDR4-3200	L83673-002

Before removing the memory, follow these steps:

1. Prepare the computer for disassembly ([Preparation for disassembly on page 30](#)).
2. Remove the bottom cover ([Bottom cover on page 30](#)).
3. Disconnect the battery cable from the system board (see [Battery on page 31](#)).

If you are replacing a memory module, remove the existing memory module:

- ▲ Spread the two retention clips outward (1) until the memory module tilts up at a 45° angle, and then remove the module (2). Use the same procedure to remove all memory modules.

 **IMPORTANT:** To prevent damage to the memory module, hold the memory module by the edges only. Do not touch the components on the memory module.

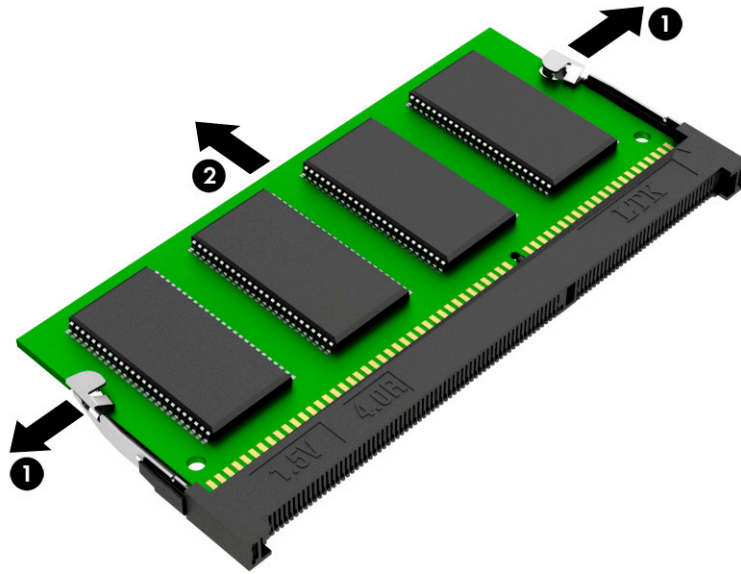

To protect a memory module after removal, place it in an electrostatic-safe container.

To install a memory module:

1. Align the notched edge of the module with the tab in the slot **(1)**, and then press the module into the slot at an angle until it is seated **(2)**.
2. Press down on the module until the side retention clips snap into place **(3)**.

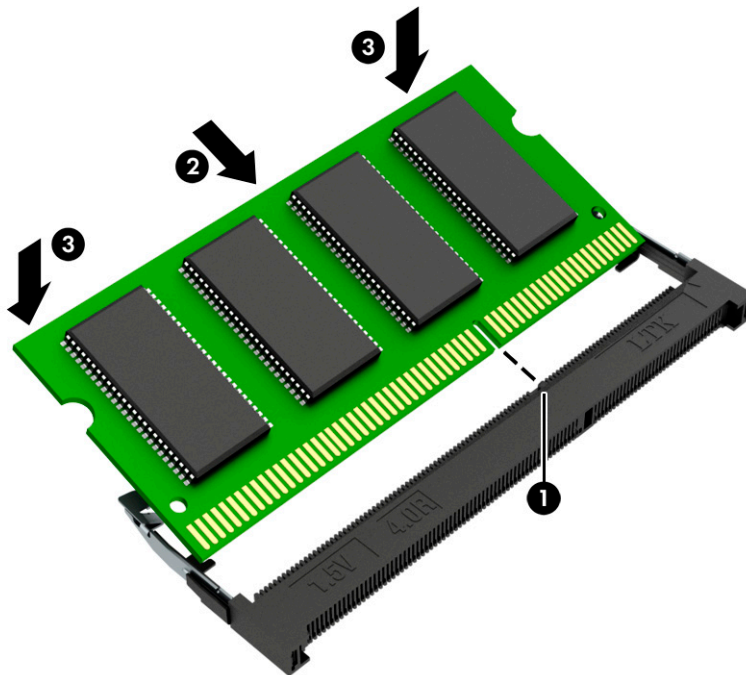

## WLAN module

To remove the WLAN module, use this procedure and illustration.

**Table 5-4 WLAN module descriptions and part numbers**

Description	Spare part number
Intel Wi-Fi 6 AX201 + Bluetooth 5 (non-vPro)	L92724-002
Intel Wireless-AC 9560 802.11ac 2 × 2 Wi-Fi + Bluetooth 5 (MU-MIMO supported)	L22634-002
Realtek RTL8822BE 802.11ac/abgn 2 × 2 + Bluetooth 5 (MU-MIMO supported)	L44796-002

 **IMPORTANT:** To prevent an unresponsive system, replace the wireless module only with a wireless module authorized for use in the computer by the governmental agency that regulates wireless devices in your country or region. If you replace the module and then receive a warning message, remove the module to restore device functionality, and then contact technical support.

Before removing the WLAN module, follow these steps:

1. Prepare the computer for disassembly ([Preparation for disassembly on page 30](#)).
2. Remove the bottom cover ([Bottom cover on page 30](#)).
3. Disconnect the battery cable from the system board (see [Battery on page 31](#)).

Remove the WLAN module:

1. Carefully disconnect the two antenna cables from the module **(1)**.
2. Remove the Phillips M2.0 × 2.5 screw **(2)**, and then remove the WLAN module **(3)**.

 **NOTE:** Models have either one or two WLAN antennas. On models with two antennas, the #1 white WLAN antenna cable connects to the WLAN module #1 Main terminal. The #2 black WLAN antenna cable connects to the WLAN module #1 Aux terminal.

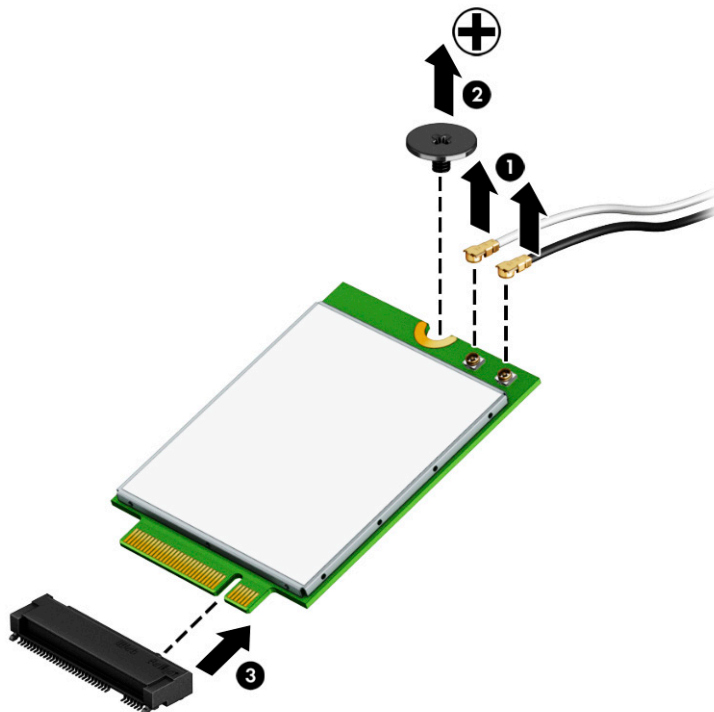

3. If the WLAN antenna is not connected to the terminal on the WLAN module, install a protective sleeve on the antenna connector, as shown in the following illustration.

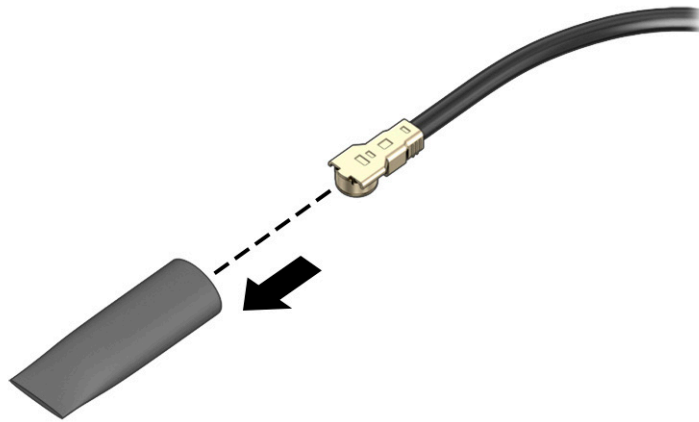

Reverse this procedure to install the WLAN module.

## WWAN module

To remove the WWAN module, use this procedure and illustration.

**Table 5-5 WWAN module descriptions and part numbers**

Description	Spare part number
Intel XMM 7360 LTE-Advanced (Cat 9)	L70670-002

**IMPORTANT:** To prevent an unresponsive system, replace the wireless module only with a wireless module authorized for use in the computer by the governmental agency that regulates wireless devices in your country or region. If you replace the module and then receive a warning message, remove the module to restore device functionality, and then contact technical support.

Before removing the WWAN module, follow these steps:

1. Prepare the computer for disassembly ([Preparation for disassembly on page 30](#)).
2. Remove the bottom cover ([Bottom cover on page 30](#)).
3. Disconnect the battery cable from the system board (see [Battery on page 31](#)).

Remove the WWAN module:

1. Disconnect the WWAN antenna cables **(1)** from the terminals on the WWAN module.  
The number of antennas can vary.
2. Remove the Phillips M2.0 × 2.0 screw **(2)** that secures the WWAN module to the bottom cover. (The WWAN module tilts up.)

3. Remove the WWAN module (3) by pulling the module away from the slot at an angle.

 **NOTE:** When viewed with the antenna terminals at the top of the module, the white WWAN antenna cables connects to the terminal to the left of the black WWAN antenna cables.

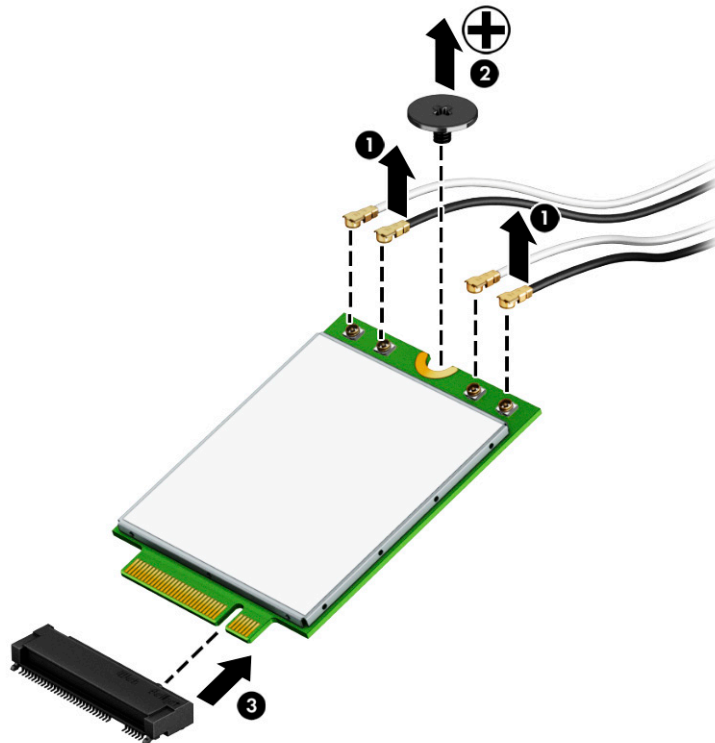

4. If the WWAN antenna is not connected to the terminal on the WWAN module, a protective sleeve must be installed on the antenna connector, as shown in the following illustration.

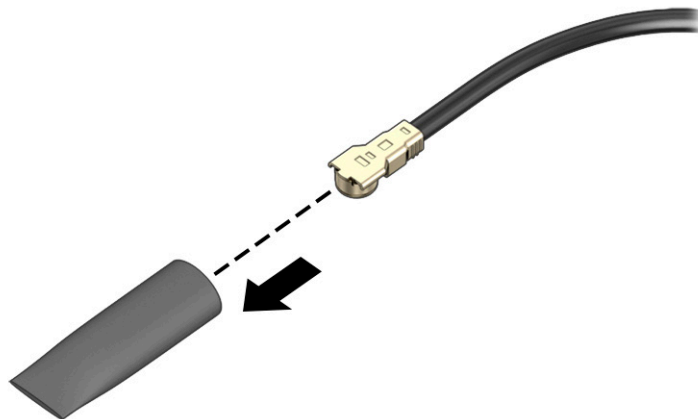

Reverse this procedure to install the WWAN module.

## Solid-state drive

To remove the M.2 solid-state drive, use this procedure and illustration.

**Table 5-6 Solid-state drive descriptions and part numbers**

Description	Spare part number
1 TB, PCIe, TLC	L85348-002
1 TB, locked	M31024-001
512 GB, PCIe, value	L85364-002
512 GB solid-state drive + 32 GB Optane memory	L85366-002
256 GB, PCIe, value	L85354-002
128 GB, PCIe, TLC	M06792-002

Before removing the solid-state drive, follow these steps:

1. Prepare the computer for disassembly ([Preparation for disassembly on page 30](#)).
2. Remove the bottom cover ([Bottom cover on page 30](#)).
3. Disconnect the battery cable from the system board (see [Battery on page 31](#)).

Remove the solid-state drive:

1. Remove the Phillips M2.0 × 2.5 screw **(1)** that secures the drive to the computer.
2. Pull the drive away from the socket to remove it **(2)**.

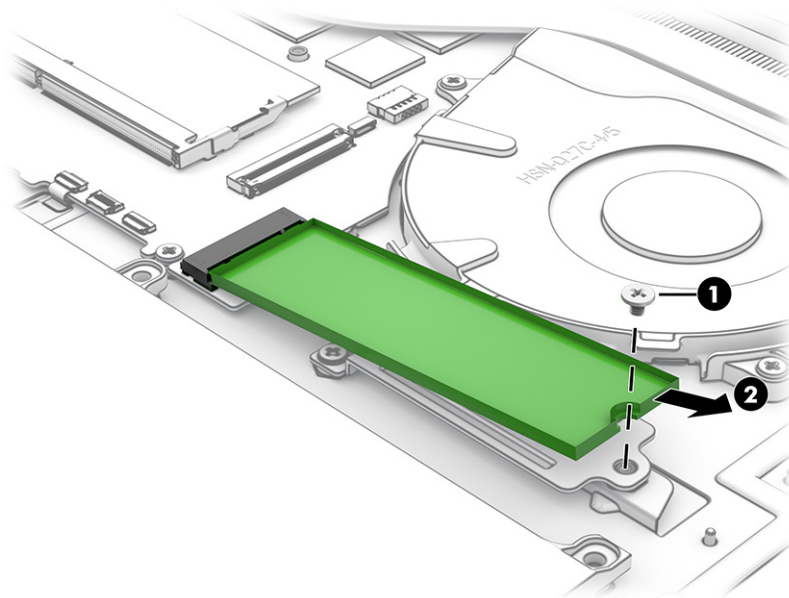

To install the solid-state drive, reverse the removal procedures.

 **NOTE:** Solid-state drives are designed with a notch to prevent incorrect insertion.

## RTC battery

To remove the RTC battery, use this procedure and illustration.

**Table 5-7** RTC battery description and part number

Description	Spare part number
RTC battery	M34737-001

Before removing the RTC battery, follow these steps:

1. Prepare the computer for disassembly ([Preparation for disassembly on page 30](#)).
2. Remove the bottom cover ([Bottom cover on page 30](#)).
3. Disconnect the battery cable from the system board (see [Battery on page 31](#)).

Remove the RTC battery:

1. Use a tool to release the battery from the computer **(1)**.
2. Disconnect the battery cable from the system board **(2)**.

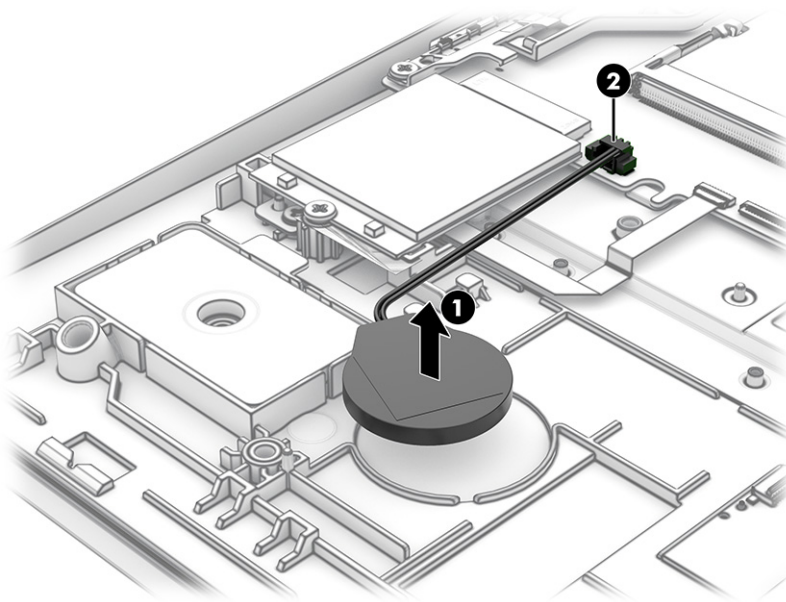

Reverse this procedure to install the RTC battery.

## I/O board

To remove the I/O board, use this procedure and illustration.

**Table 5-8** I/O board description and part number

Description	Spare part number
I/O board	M21712-001
I/O board cables (included in Cable Kit)	M21713-001
RJ-45 door (included in Plastics Kit)	M21714-001

Before removing the I/O board, follow these steps:

1. Prepare the computer for disassembly ([Preparation for disassembly on page 30](#)).
2. Remove the bottom cover ([Bottom cover on page 30](#)).
3. Disconnect the battery cable from the system board (see [Battery on page 31](#)).

Remove the I/O board:

1. Disconnect the cable from the larger ZIF connector **(1)** and smaller ZIF connector **(2)** on the I/O board.
2. Remove the three Phillips M2.0 × 4.0 screws **(3)** that secure the board to the computer, and then remove the network jack door from the board **(4)**.
3. Remove the board from the computer **(5)**.

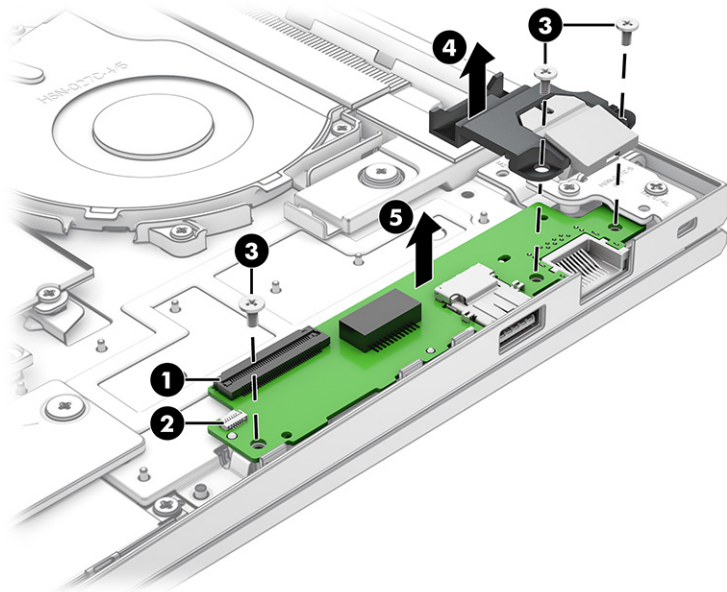

Reverse this procedure to install the I/O board.

## Touchpad

To remove the touchpad, use this procedure and illustration.

**Table 5-9 Touchpad description and part number**

Description	Spare part number
Touchpad	M21999-001
Touchpad cable (included in Cable Kit)	M21713-001

Before removing the touchpad, follow these steps:

1. Prepare the computer for disassembly ([Preparation for disassembly on page 30](#)).
2. Remove the bottom cover ([Bottom cover on page 30](#)).
3. Remove the battery (see [Battery on page 31](#)).

Remove the touchpad:



1. Disconnect the system board cable from the ZIF connector on the touchpad **(1)**.
2. Remove the five Phillips M2.0× 2.0 screws **(2)** that secure the touchpad to the computer.
3. Remove the Phillips M1.6 × 2.0 screw **(3)** that secures the touchpad to the computer.
4. Remove the touchpad from the computer **(4)**.

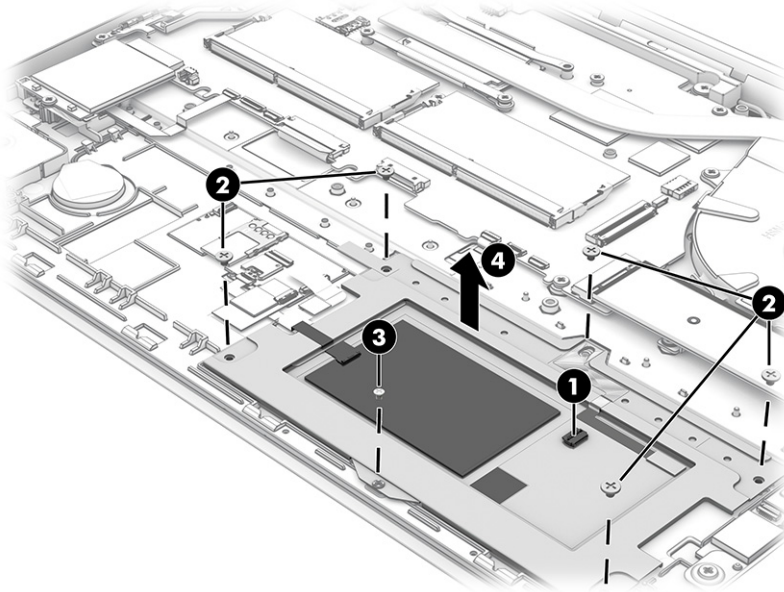

Reverse this procedure to install the touchpad.

## Fan

To remove the fan, use this procedure and illustration.

**Table 5-10 Fan description and part number**

Description	Spare part number
Fan for use in models with discrete graphics	M21719-001
Fan for use in models with UMA graphics	M21718-001

Before removing the fan, follow these steps:

1. Prepare the computer for disassembly ([Preparation for disassembly on page 30](#)).
2. Remove the bottom cover ([Bottom cover on page 30](#)).
3. Disconnect the battery cable from the system board (see [Battery on page 31](#)).

Remove the fan assembly:

1. Remove display cable from the clips on the right side of the fan **(1)**.
2. Remove the three Phillips 2.0 × 4.0 screws **(2)** that secure the fan to the computer.
3. Disconnect the fan cable from the system board **(3)**.

4. Remove the fan from the computer **(4)**.

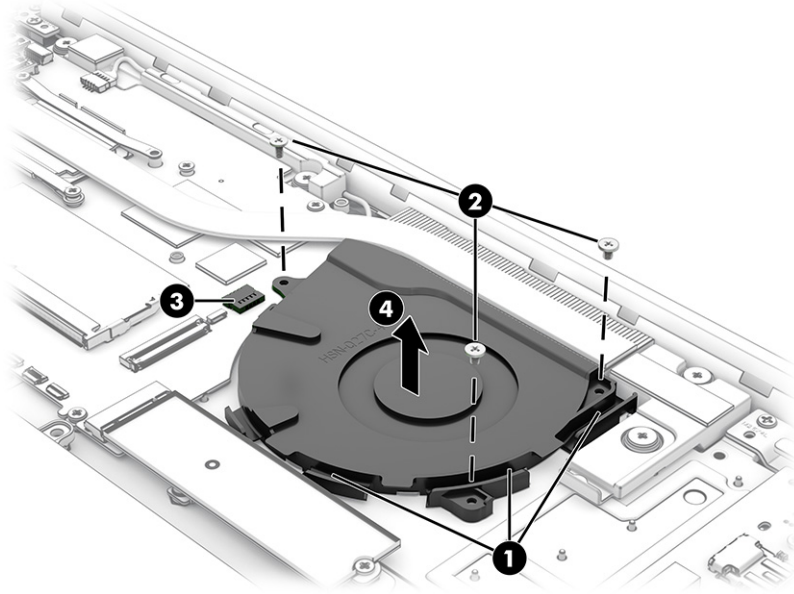

Reverse this procedure to install the fan assembly.

## Fingerprint reader board

To remove the fingerprint reader board, use this procedure and illustration.

**Table 5-11 Fingerprint reader board description and part number**

Description	Spare part number
Fingerprint reader board (includes conductive tape)	M21724-001
Fingerprint reader board cable (included in Cable Kit)	M21713-001
Fingerprint reader board bracket (included in Bracket Kit)	M21715-001

Before removing the fingerprint reader board, follow these steps:

1. Prepare the computer for disassembly ([Preparation for disassembly on page 30](#)).
2. Remove the bottom cover ([Bottom cover on page 30](#)).
3. Disconnect the battery cable from the system board (see [Battery on page 31](#)).

Remove the fingerprint reader board:

1. Disconnect the cable from the ZIF connector on the fingerprint reader board **(1)**.
2. Remove the Phillips M2.0 × 2.5 screw **(2)** that secures the fingerprint reader bracket to the computer, and then remove the bracket **(3)**.

3. Remove the fingerprint reader board from the computer (4).

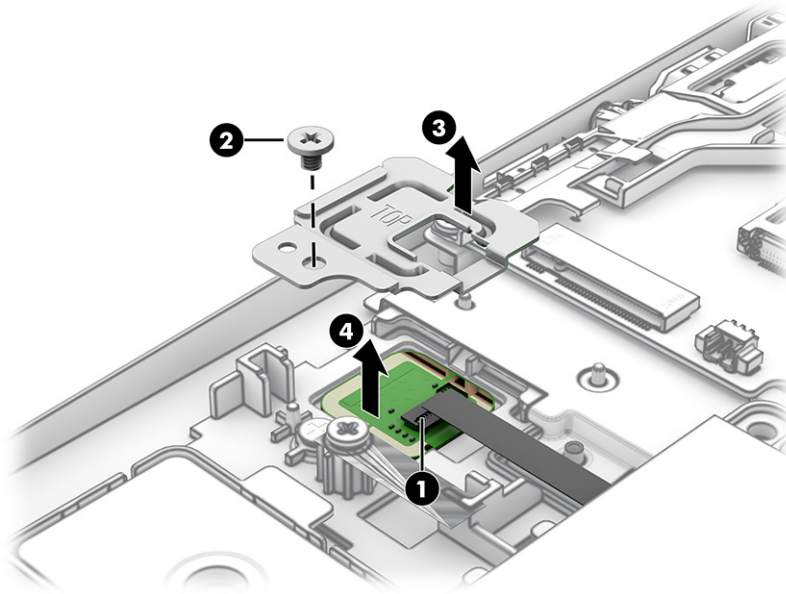

Reverse this procedure to install the fingerprint reader board.

## Heat sink

To remove the heat sink, use these procedures and illustrations.

**Table 5-12 Heat sink descriptions and part numbers**

Description	Spare part number
Heat sink for use in models with discrete graphics memory	M21717-001
Heat sink for use in models with UMA graphics memory	M21716-001

Before removing the heat sink, follow these steps:

1. Prepare the computer for disassembly ([Preparation for disassembly on page 30](#)).
2. Remove the bottom cover ([Bottom cover on page 30](#)).
3. Disconnect the battery cable from the system board (see [Battery on page 31](#)).

Remove the heat sink:

1. **Discrete graphics models:** In the order indicated on the heat sink, loosen the six captive Phillips screws (1) that secure the heat sink to the computer.

2. Remove the heat sink from the computer (2).

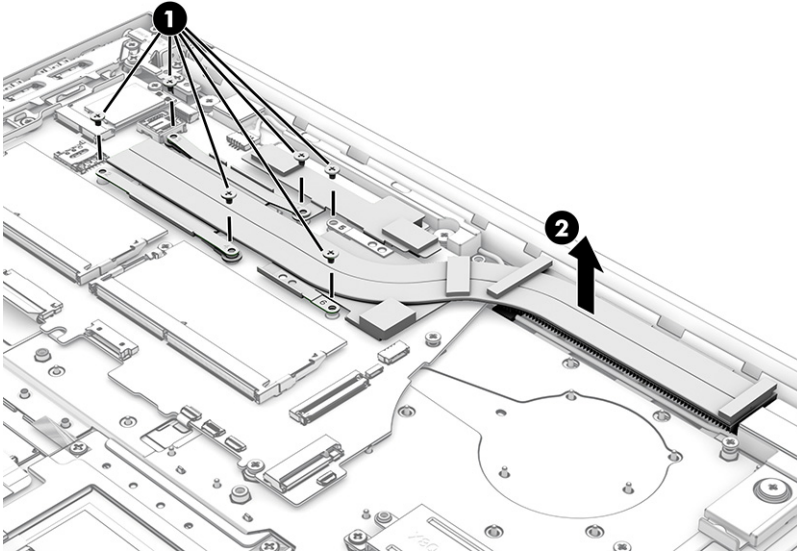

3. Thoroughly clean the thermal material from the surfaces of the heat sink and the system board components each time the heat sink is removed. Replacement thermal material is included with the heat sink and system board spare part kits. The following illustration shows the replacement thermal material locations.

Thermal material is used on the heat sink (1) and associated system board components (2).

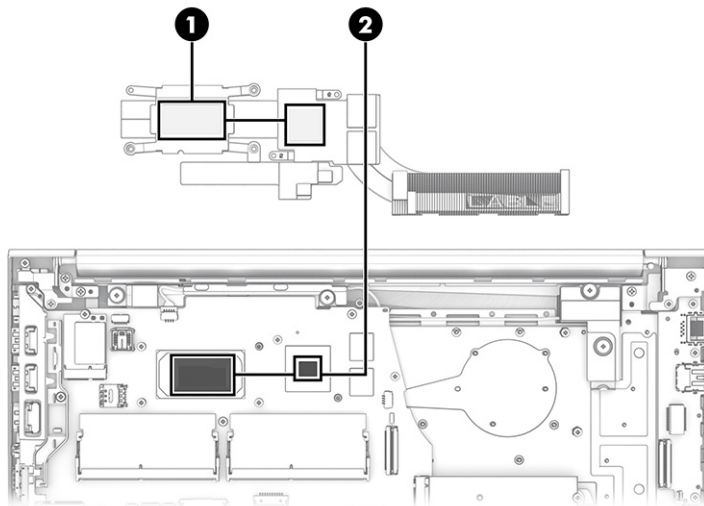

4. **UMA models:** In the order indicated on the heat sink, loosen the six captive Phillips screws (1) that secure the heat sink to the computer.

5. Remove the heat sink from the computer (2).

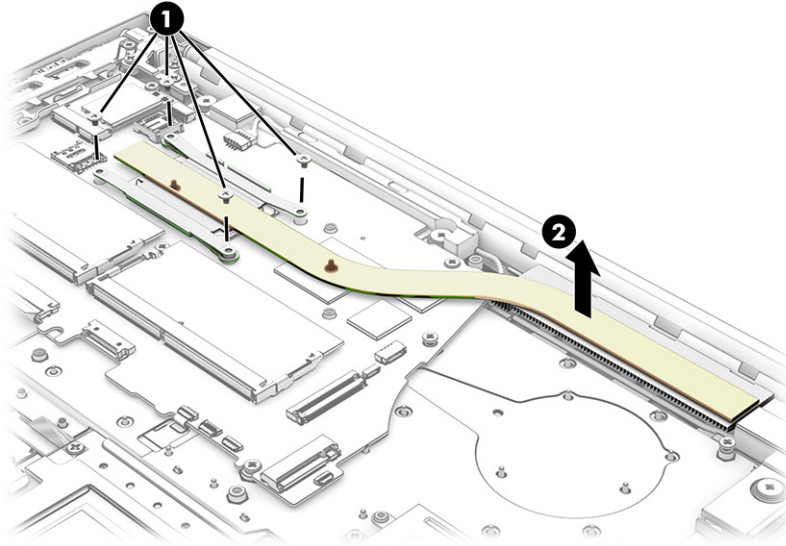

6. Thoroughly clean the thermal material from the surfaces of the heat sink and the system board components each time the heat sink is removed. Replacement thermal material is included with the heat sink and system board spare part kits. The following illustration shows the replacement thermal material locations.

Thermal material is used on the heat sink (1) and associated system board component (2).

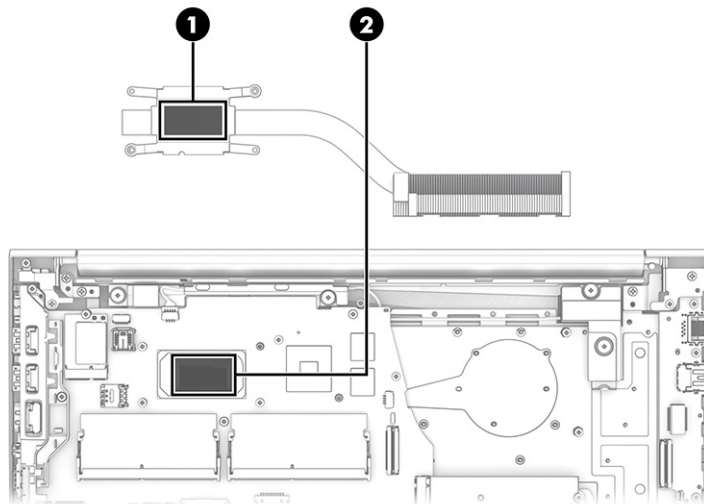

Reverse this procedure to install the heat sink.

## System board

To remove the system board, use these procedures and illustrations.

**Table 5-13 System board descriptions and part numbers**

Description	Spare part number
<b>System board</b> (includes integrated processor)	
All system boards use the following part numbers:	
xxxxxx-001: Non-Windows operating systems	
xxxxxx-601: Windows operating system	
System board for use in models with discrete graphics	
• Intel Core i7-1185G7 processor	M21690-xx1
• Intel Core i7-1165G7 processor	M21692-xx1
• Intel Core i5-1135G7 processor	M21688-xx1
• Intel Core i3-1115G4 processor	M21684-xx1
System board for use in models with UMA graphics	
• Intel Core i7-1185G7 processor	M21706-xx1
• Intel Core i7-1165G7 processor	M21708-xx1
• Intel Core i5-1135G7 processor	M21702-xx1
• Intel Core i5-1135G7 processor (WWAN models)	M21704-xx1
• Intel Core i3-1115G4 processor	M21696-xx1
• Intel Core i3-1115G4 processor (WWAN models)	M21698-xx1

Before removing the system board, follow these steps:

1. Prepare the computer for disassembly ([Preparation for disassembly on page 30](#)).
2. Remove the bottom cover ([Bottom cover on page 30](#)).
3. Remove the battery (see [Battery on page 31](#)).
4. Remove the fan (see [Fan on page 41](#)).

When you replace the system board, be sure to remove the following components (as applicable) from the defective system board and install them on the replacement system board:

- Memory modules (see [Memory modules on page 33](#)).
- WLAN module (see [WLAN module on page 34](#)).
- WWAN module (see [WWAN module on page 36](#)).
- Solid-state drive (see [Solid-state drive on page 38](#)).
- Heat sink (see [Heat sink on page 43](#)).

Remove the system board:

1. Disconnect the following cables from the system board:
  - Antenna cables from the WLAN module (select products only) **(1)**
  - Power connector cable **(2)**

- Speaker cable **(3)**
- Display cable **(4)**
- USB cable (ZIF) from USB board **(5)**
- USB cable (ZIF) from system board **(6)**
- Touchpad cable (ZIF) **(7)**
- Keyboard backlight cable (ZIF) (select products only) **(8)**
- Keyboard cable (ZIF) **(9)**
- Fingerprint reader cable (ZIF) (select products only) **(10)**
- RTC battery cable **(11)**
- WWAN cable **(12)**

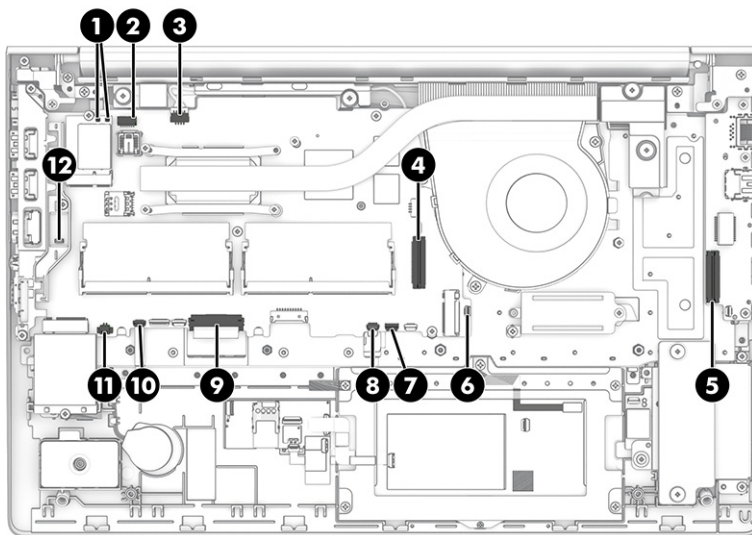

2. Remove the port bracket **(1)**, by removing the three Phillips M2.0 × 4.0 screws **(2)** that secure the bracket to the system board, and then removing the bracket **(3)**.
3. Remove the two Phillips M2.0 × 2.5 screws **(4)** that secure the system board to the computer.

4. Lift the side of the system board upward **(5)**, and then pull the system board away from the connectors on the side of the computer to remove it **(6)**.

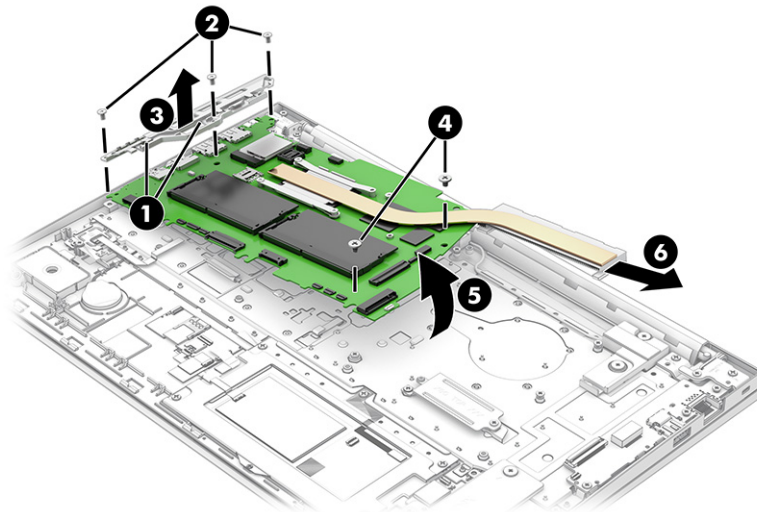

Reverse this procedure to install the system board.

## Speakers

To remove the speakers, use this procedure and illustration.

**Table 5-14 Speaker description and part number**

Description	Spare part number
Speakers	M21723-001

Before removing the speakers, follow these steps:

1. Prepare the computer for disassembly ([Preparation for disassembly on page 30](#)).
2. Remove the bottom cover ([Bottom cover on page 30](#)).
3. Remove the battery (see [Battery on page 31](#)).
4. Remove the system board (see [System board on page 45](#)).

Remove the speakers:

1. Remove the two Phillips M2.0 × 2.0 screws **(1)** that secure each speaker to the computer.



2. Remove the speakers from the computer **(2)** .

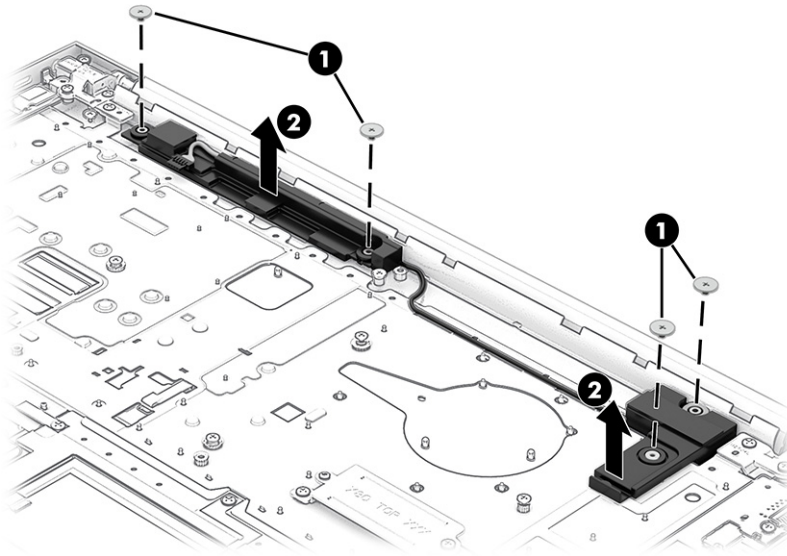

Reverse this procedure to install the speakers.

## Power connector cable

To remove the power connector cable, use this procedure and illustration.

**Table 5-15** Power connector cable description and part number

Description	Spare part number
Power connector cable	M21725-001

Before removing the power connector cable, follow these steps:

1. Prepare the computer for disassembly ([Preparation for disassembly on page 30](#)).
2. Remove the bottom cover ([Bottom cover on page 30](#)).
3. Disconnect the battery cable from the system board (see [Battery on page 31](#)).

Remove the power connector cable:

1. Remove the two Phillips M2.5 × 4.0 screws **(1)** that secure the right display hinge to the computer, and then rotate the hinge off the power connector **(2)**.
2. Remove the Phillips M2.0 × 4.0 screw **(3)** that secures the power connector to the computer.
3. Disconnect the cable from the system board **(4)**.

4. Remove the power connector cable from the computer (5).

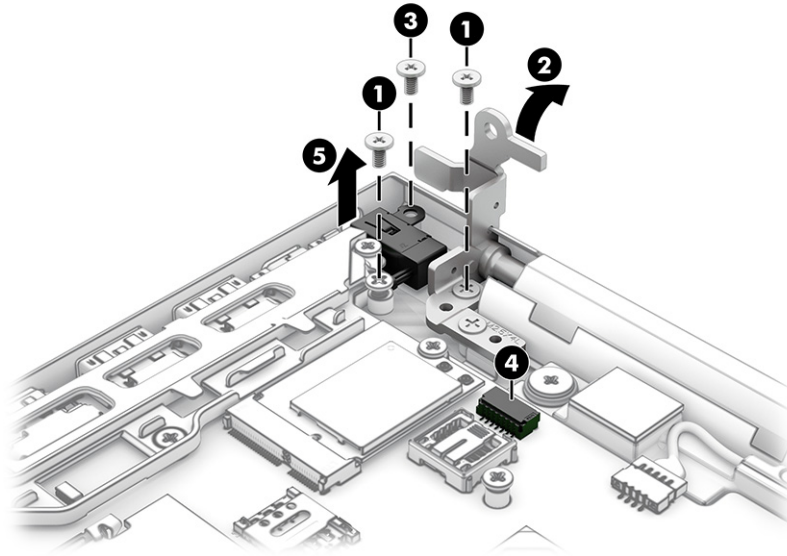

Reverse this procedure to install the power connector cable.

## Display assembly

To remove and disassemble the display assembly, use these procedures and illustrations.

Full hinge-up displays are not available as spare parts. Spare parts for displays are available only at the subcomponent level.

Before removing the display panel, follow these steps:

1. Prepare the computer for disassembly ([Preparation for disassembly on page 30](#)).
2. Remove the bottom cover ([Bottom cover on page 30](#)).
3. Disconnect the battery cable from the system board (see [Battery on page 31](#)).
4. Remove the power connector cable ([Power connector cable on page 49](#)).

Remove the display assembly:

1. If you need to remove the bezel:
  - a. Flex the top (1), the left and right sides (2), and then the bottom of the bezel (3) to release it.
  - b. Remove the bezel from the display (4).

The display bezel is available as the following spare part numbers:

M21991-001: Models without a camera

M21992-001: Models with an HD camera

M21993-001: Models with an HD + IR camera

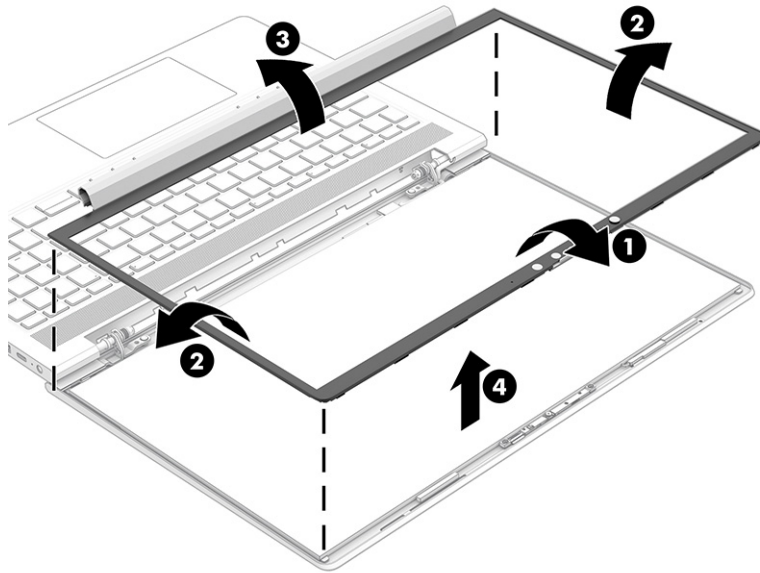

**2.** If you need to remove the display panel:

- a.** Check the fit of the various alignment tools on the display assembly. Make note of the best fitting alignment tool to use when replacing the display panel.
- b.** The display panel is secured to the display enclosure with tape that is installed under the left and right sides of the panel. You have to pull the tape out from behind the panel from all four corners of the panel. To remove the panel, use tweezers to grasp and pull the end of the tape out from behind the panel **(1)**. While turning the tweezers, wrap the tape around the tweezers **(2)** as you continue to pull the tape out from behind the display panel. You must pull the tape multiple times before it is completely removed.

- c. Rotate the display panel over and place it next to the display enclosure **(3)**.

Display panels are available as the following spare part numbers:

M21739-001: FHD, 1000 nit, privacy panel

M22541-001: FHD, 400 nit panel

M31023-001: FHD, 400 nit panel, locked

M21736-001: HD, SVA, 250 nits

M21737-001: FHD, UWVA, 250 nits

M21738-001: FHD, UWVA, 250 nits, TOP (Touch-on Panel)

M31021-001: FHD, UWVA, 250 nits, locked

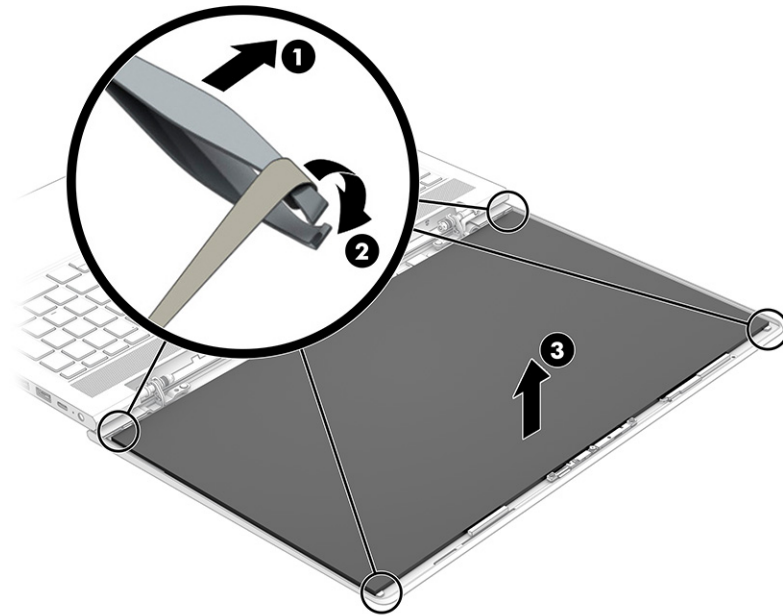

- d. Lift the tape from the connector on the display panel **(1)**, and then disconnect the cable from the panel **(2)**.

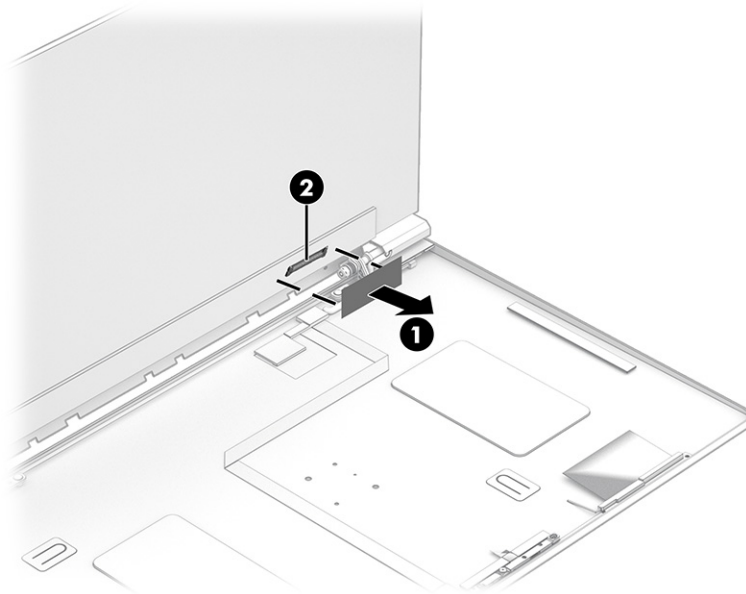

3. Use the following illustration to determine proper adhesive installation locations on the display rear cover. Before installing the display panel, be sure to connect the display cable to the back of the panel.

The display panel tape is available in the LCD Support Kit as spare part number M23560-001.

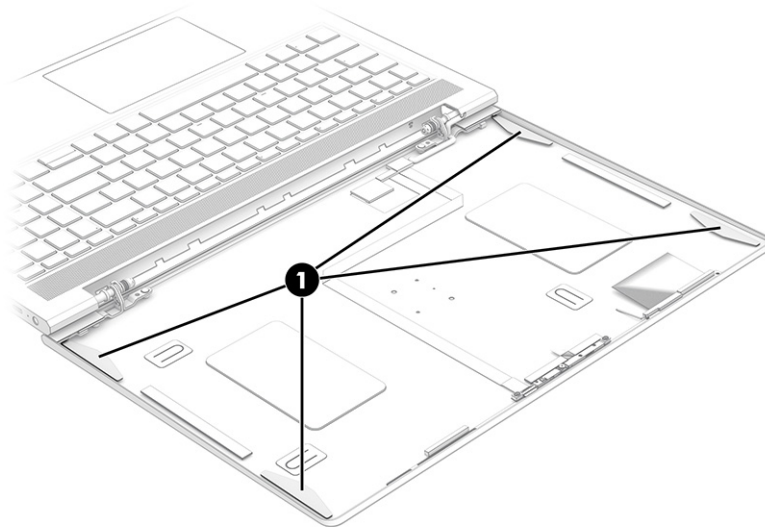

4. If you need to remove the camera module:
- ▲ Use a tool to lift up evenly across the module and peel the module up from the display back cover **(1)**, and then disconnect the cable from the reverse ZIF connector on the module **(2)**. The camera module is available as spare part number M29583-001 for HD cameras and M27889-001 for IR cameras. The microphone module (for use in models without a camera module) is available as spare part number M27888-001.

 **NOTE:** For installation, note that the cable routes under the camera module before it connects to the module.

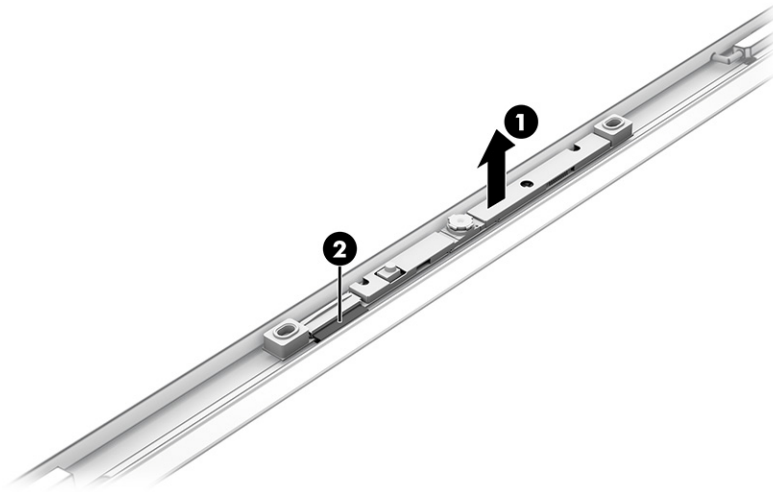

5. To remove the remainder of the display subcomponents, you must remove the display assembly from the computer. To remove the display assembly, disconnect the antenna cables from the WLAN module (1).
6. Remove the cables from the clips around the fan (2), and disconnect the display cable (3).
7. Disconnect the antenna cables from the WWAN module (4).
8. Remove the cables from the clips (5).
9. Disconnect the WWAN cable from the system board (6).

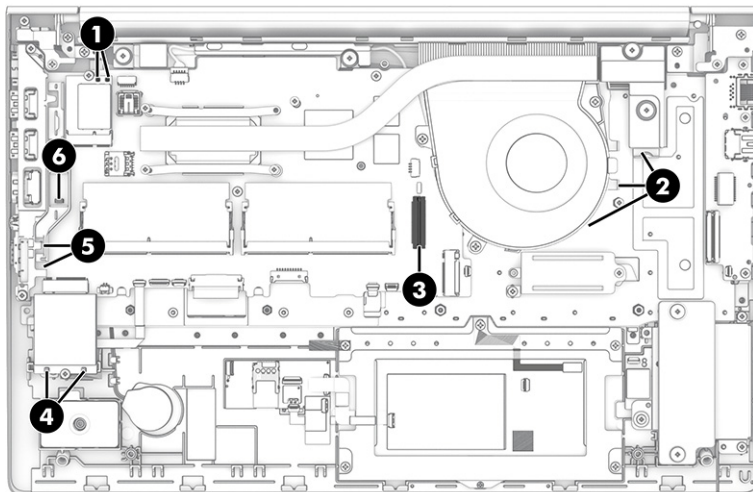

10. Remove the four Phillips M2.5 × 4.0 screws (1) that secure the display assembly to the computer.
11. Rotate the display to open the hinges (2).

- 12.** Separate the display assembly from the computer **(3)**.

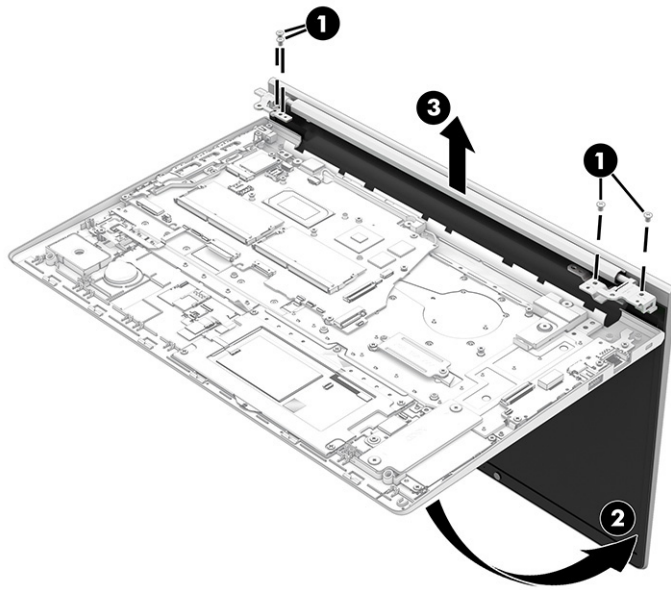

- 13.** If you need to remove the hinges from the display enclosure:

- a. Remove the trim pieces **(1)**.
- b. Remove the two Phillips M2.0 × 2.5 screws **(2)** from each hinge.
- c. Remove the Phillips M2.5 × 4.0 screw **(3)** from each hinge.
- d. Remove the hinges from the display **(4)**.

The hinges and associated parts are available in the Hinge Kit as spare part number M21732-001.

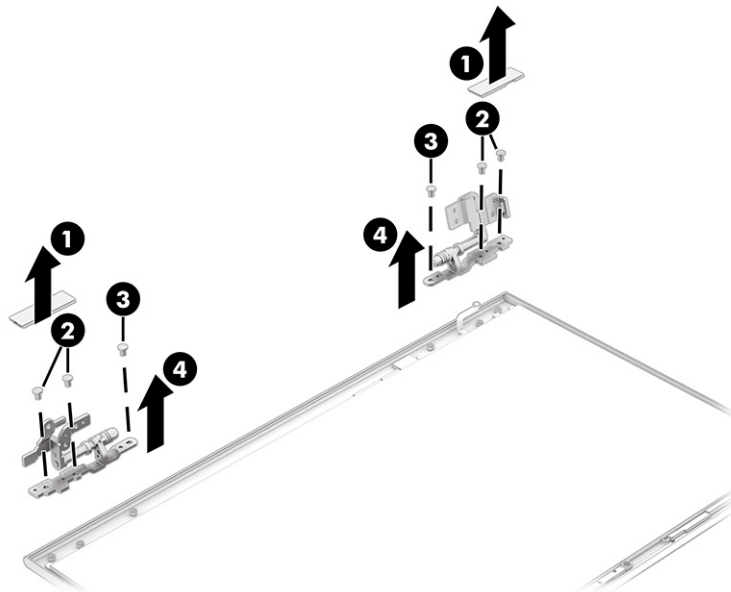

14. If you need to remove the display panel/camera cable, peel the cable up off the inside of the display rear cover.

The display panel/camera cable is available as spare part number M21733-001.

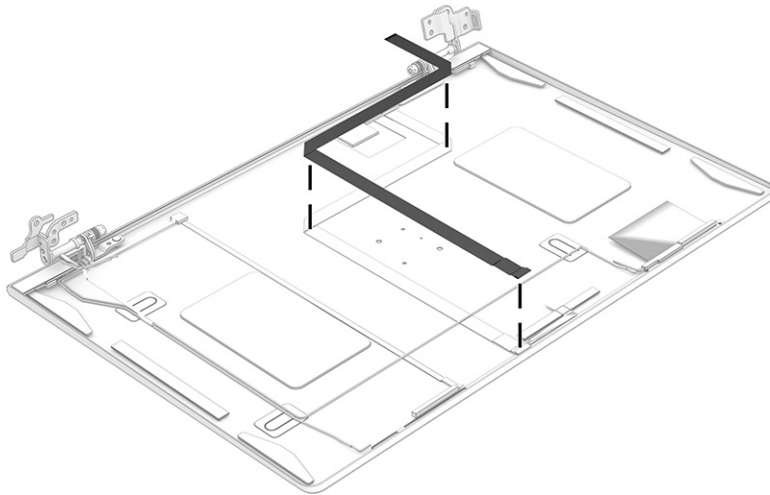

15. If you need to remove the WLAN antennas and cables, remove the cables from the plastic clips at the bottom-right and the clips on the inside of the display rear cover (1), and then peel the antennas off the cover (2). The WLAN antennas and cables are available as spare part number M21727-001.

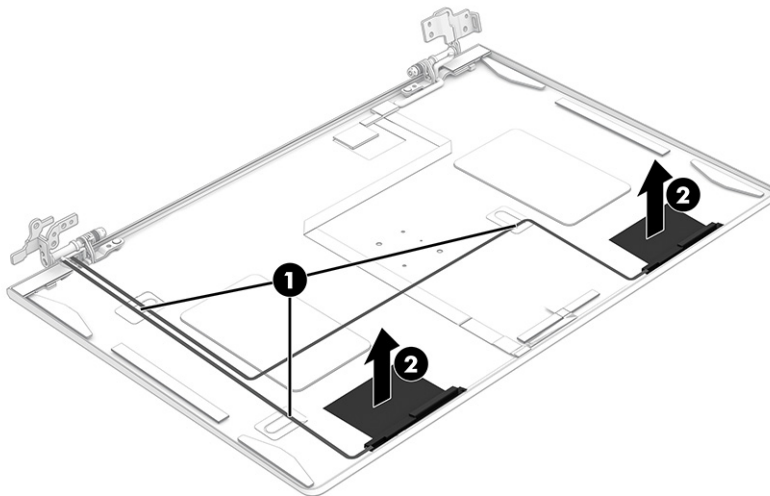



16. If you need to remove the WWAN antennas and cables, disconnect the cable from the WWAN antenna (1), remove the cables from the plastic clips and the clips on the inside of the display rear cover (2), and then peel the antennas off the cover (3). The WWAN antennas and cables are available as spare part number M21728-001.

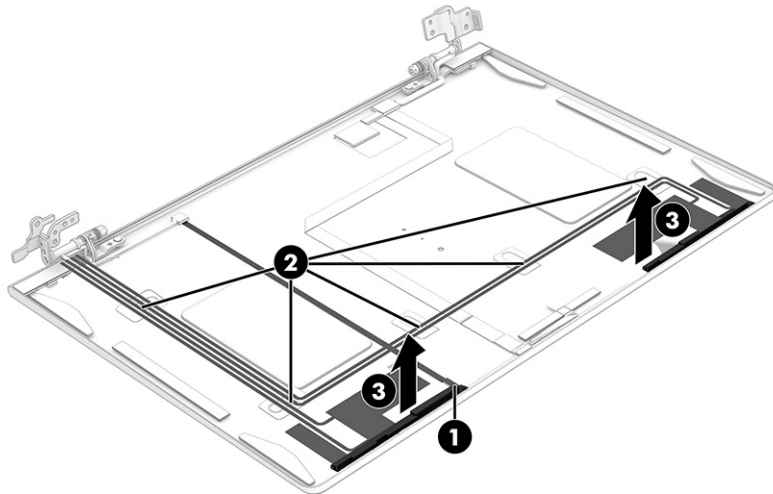

The display rear covers are available as the following spare part numbers:

M21987-001: Models with a 250 nit panel, WLAN, no WWAN

M21988-001: Models with a 250 nit panel, WLAN, and WWAN

M21989-001: Models with a 400 nit panel, WLAN, no WWAN

Reverse this procedure to reassemble and replace the display assembly.

## Top cover with keyboard

The top cover with keyboard remains after removing all other spare parts from the computer. In this section, the first table provides the main spare part number for the top cover/keyboards. The second table provides the country codes.

**Table 5-16 Top cover with keyboard descriptions and part numbers**

Description	Spare part number
Top cover with keyboard, not backlit	M21740-xx1
Top cover with keyboard, backlit, for use in privacy models	M21741-xx1
Top cover with keyboard, backlit	M21742-xx1

**Table 5-17 Spare part country codes**

For use in country or region	Spare part number	For use in country or region	Spare part number	For use in country or region	Spare part number
Belgium	-A41	Hungary	-211	Saudi Arabia	-171
Brazil	-201	Iceland	-DD1	Slovenia	-BA1

**Table 5-17 Spare part country codes (continued)**

<b>For use in country or region</b>	<b>Spare part number</b>	<b>For use in country or region</b>	<b>Spare part number</b>	<b>For use in country or region</b>	<b>Spare part number</b>
Bulgaria	-261	India	-D61	South Korea	-AD1
Chile	-161	Israel	-BB1	Spain	-071
Czech Republic/Slovakia	-FL1	Italy	-061	Switzerland	-BG1
Denmark	-081	Japan	-291	Taiwan	-AB1
Denmark, Finland, and Norway	-DH1	The Netherlands	-B31	Thailand	-281
French Canada	-DB1	Northern Africa	-FP1	Turkey	-141
Finland/Sweden	-B71	Norway	-091	Turkey-F	-541
France	-051	Portugal	-131	Ukraine	-BD1
Germany	-041	Romania	-271	United Kingdom	-031
Greece	-151	Russia	-251	United States	-001

---

# 6 Computer Setup (BIOS), TPM, and HP Sure Start

HP provides several tools to help set up and protect your computer.

## Using Computer Setup

Computer Setup, or Basic Input/Output System (BIOS), controls communication between all the input and output devices on the system (such as hard drives, display, keyboard, mouse, and printer). Computer Setup includes settings for types of devices installed, the startup sequence of the computer, and amount of system and extended memory.

---

 **NOTE:** Use extreme care when making changes in Computer Setup. Errors can prevent the computer from operating properly.

---

To start Computer Setup, turn on or restart the computer, and when the HP logo appears, press **f10** to enter Computer Setup.

## Navigating and selecting in Computer Setup

You can navigate and select in Computer Setup using one or more methods.

- To select a menu or a menu item, use the **tab** key and the keyboard arrow keys and then press **enter**, or use a pointing device to select the item.
- To scroll up and down, select the up arrow or the down arrow in the upper-right corner of the screen, or use the up arrow key or the down arrow key on the keyboard.
- To close open dialog boxes and return to the main Computer Setup screen, press **esc**, and then follow the on-screen instructions.

To exit Computer Setup, choose one of the following methods:

- To exit Computer Setup menus without saving your changes, select **Main**, select **Ignore Changes and Exit**, and then select **Yes**.

---

 **NOTE:** If you are using arrow keys to highlight your choice, you must then press **enter**.

---

- To save your changes and exit Computer Setup menus, select **Main**, select **Save Changes and Exit**, and then select **Yes**.

---

 **NOTE:** If you are using arrow keys to highlight your choice, you must then press **enter**.

---

Your changes go into effect when the computer restarts.

## Restoring factory settings in Computer Setup

To return all settings in Computer Setup to the values that were set at the factory, follow these steps.

---

 **NOTE:** Restoring defaults will not change the hard drive mode.

---

1. Start Computer Setup. See [Using Computer Setup on page 59](#).
2. Select **Main**, select **Apply Factory Defaults and Exit**, and then select **Yes**.

---

 **NOTE:** If you are using arrow keys to highlight your choice, you must then press [enter](#).

 **NOTE:** On select products, the selections might display **Restore Defaults** instead of **Apply Factory Defaults and Exit**.

---

Your changes go into effect when the computer restarts.

---

 **NOTE:** Your password settings and security settings are not changed when you restore the factory settings.

---

## Updating the BIOS

Updated versions of the BIOS might be available on the HP website. Most BIOS updates on the HP website are packaged in compressed files called *SoftPaqs*.

Some download packages contain a file named *Readme.txt*, which contains information regarding installing and troubleshooting the file.

### Determining the BIOS version

To decide whether you need to update Computer Setup (BIOS), first determine the BIOS version on your computer.

You can access BIOS version information (also known as *ROM date* and *System BIOS*) by pressing [fn+esc](#) (if you are already in Windows) or by using Computer Setup.

1. Start Computer Setup. See [Using Computer Setup on page 59](#).
2. Select **Main**, and then select **System Information**.
3. To exit Computer Setup menus without saving your changes, select **Main**, select **Ignore Changes and Exit**, and then select **Yes**.

---

 **NOTE:** If you are using arrow keys to highlight your choice, you must then press [enter](#).

---

To check for later BIOS versions, see [Preparing for a BIOS update on page 60](#).

### Preparing for a BIOS update

Be sure to follow all prerequisites before downloading and installing a BIOS update.

---

 **IMPORTANT:** To reduce the risk of damage to the computer or an unsuccessful installation, download and install a BIOS update only when the computer is connected to reliable external power using the AC adapter. Do not download or install a BIOS update while the computer is running on battery power, docked in an optional docking device, or connected to an optional power source. During the download and installation, follow these instructions:

Do not disconnect power on the computer by unplugging the power cord from the AC outlet.

Do not shut down the computer or initiate Sleep.

Do not insert, remove, connect, or disconnect any device, cable, or cord.

---

### Downloading a BIOS update

After you review the prerequisites, you can check for and download BIOS updates.

1. Type `support` in the taskbar search box, and then select the HP Support Assistant app.  
– or –  
Select the question mark icon in the taskbar.
2. Select **Updates**, and then select **Check for updates and messages**.
3. Follow the on-screen instructions.
4. At the download area, follow these steps:
  - a. Identify the most recent BIOS update and compare it to the BIOS version currently installed on your computer. Make a note of the date, name, or other identifier. You might need this information to locate the update later, after it has been downloaded to your hard drive.
  - b. Follow the on-screen instructions to download your selection to the hard drive.  
  
Make a note of the path to the location on your hard drive where the BIOS update is downloaded. You will need to access this path when you are ready to install the update.

---

 **NOTE:** If you connect your computer to a network, consult the network administrator before installing any software updates, especially system BIOS updates.

---

### Installing a BIOS update

BIOS installation procedures vary. Follow any instructions that are displayed on the screen after the download is complete. If no instructions are displayed, follow these steps.

1. Type `file` in the taskbar search box, and then select **File Explorer**.
2. Select your hard drive designation. The hard drive designation is typically Local Disk (C:).
3. Using the hard drive path you recorded earlier, open the folder that contains the update.
4. Double-click the file that has an `.exe` extension (for example, `filename.exe`).  
  
The BIOS installation begins.
5. Complete the installation by following the on-screen instructions.

---

 **NOTE:** After a message on the screen reports a successful installation, you can delete the downloaded file from your hard drive.

---

### Changing the boot order using the f9 prompt

To dynamically choose a boot device for the current startup sequence, follow these steps.

1. Access the Boot Device Options menu:
  - Turn on or restart the computer, and when the HP logo appears, press **f9** to enter the Boot Device Options menu.
2. Select a boot device, press `enter`, and then follow the on-screen instructions.

## TPM BIOS settings (select products only)

TPM provides additional security for your computer. You can modify the TPM settings in Computer Setup (BIOS).

---

 **IMPORTANT:** Before enabling Trusted Platform Module (TPM) functionality on this system, you must ensure that your intended use of TPM complies with relevant local laws, regulations and policies, and approvals or licenses must be obtained if applicable. For any compliance issues arising from your operation or usage of TPM that violates the previously mentioned requirement, you shall bear all the liabilities wholly and solely. HP will not be responsible for any related liabilities.

 **NOTE:** If you change the TPM setting to Hidden, TPM is not visible in the operating system.

---

To access TPM settings in Computer Setup:

1. Start Computer Setup. See [Using Computer Setup on page 59](#).
2. Select **Security**, select **TPM Embedded Security**, and then follow the on-screen instructions.

## Using HP Sure Start (select products only)

Select computer models are configured with HP Sure Start, a technology that monitors the computer's BIOS for attacks or corruption. If the BIOS becomes corrupted or is attacked, HP Sure Start automatically restores the BIOS to its previously safe state, without user intervention.

HP Sure Start is configured and already enabled so that most users can use the HP Sure Start default configuration. Advanced users can customize the default configuration.

To access the latest documentation on HP Sure Start, go to <http://www.hp.com/support>. Select **Find your product**, and then follow the on-screen instructions.

---

# 7 Backing up, restoring, and recovering

You can use Windows tools or HP software to back up your information, create a restore point, reset your computer, create recovery media, or restore your computer to its factory state. Performing these standard procedures can return your computer to a working state faster.

---

 **IMPORTANT:** If you will be performing recovery procedures on a tablet, the tablet battery must be at least 70% charged before you start the recovery process.

**IMPORTANT:** For a tablet with a detachable keyboard, connect the tablet to the keyboard base before beginning any recovery process.

---

## Backing up information and creating recovery media

These methods of creating recovery media and backups are available on select products only.

### Using Windows tools for backing up

HP recommends that you back up your information immediately after initial setup. You can do this task either using Windows Backup locally with an external USB drive or using online tools.

---

 **IMPORTANT:** Windows is the only option that allows you to back up your personal information. Schedule regular backups to avoid information loss.

 **NOTE:** If computer storage is 32 GB or less, Microsoft System Restore is disabled by default.

---

### Using the HP Cloud Recovery Download Tool to create recovery media (select products only)

You can use the HP Cloud Recovery Download Tool to create HP Recovery media on a bootable USB flash drive.

For details:

- ▲ Go to <http://www.hp.com/support>, search for HP Cloud Recovery, and then select the result that matches the type of computer that you have.

---

 **NOTE:** If you cannot create recovery media yourself, contact support to obtain recovery discs. Go to <http://www.hp.com/support>, select your country or region, and then follow the on-screen instructions.

 **IMPORTANT:** HP recommends that you follow the [Restoring and recovery methods on page 64](#) to restore your computer before you obtain and use the HP recovery discs. Using a recent backup can return your machine to a working state sooner than using the HP recovery discs. After the system is restored, reinstalling all the operating system software released since your initial purchase can be a lengthy process.

---

## Restoring and recovering your system

You have several tools available to recover your system both within and outside of Windows if the desktop cannot load.

HP recommends that you attempt to restore your system using the [Restoring and recovery methods on page 64](#).

## Creating a system restore

System Restore is available in Windows. The System Restore software can automatically or manually create restore points, or snapshots, of the system files and settings on the computer at a particular point.

When you use System Restore, it returns your computer to its state at the time you made the restore point. Your personal files and documents should not be affected.

## Restoring and recovery methods

After you run the first method, test to see whether the issue still exists before you proceed to the next method, which might now be unnecessary.

1. Run a Microsoft System Restore.
2. Run Reset this PC.
3. Recover using HP Recovery media. For more information, see [Recovering using HP Recovery media on page 64](#).

For more information about the first two methods, see the Get Help app:

Select the **Start** button, select the **Get Help** app, and then enter the task you want to perform.



---

**NOTE:** You must be connected to the internet to access the Get Help app.

---

## Recovering using HP Recovery media

You can use HP Recovery media to recover the original operating system and software programs that were installed at the factory. On select products, it can be created on a bootable USB flash drive using the HP Cloud Recovery Download Tool.

For details, see [Using the HP Cloud Recovery Download Tool to create recovery media \(select products only\) on page 63](#).



---

**NOTE:** If you cannot create recovery media yourself, contact support to obtain recovery discs. Go to <http://www.hp.com/support>, select your country or region, and then follow the on-screen instructions.

---

To recover your system:

- ▲ Insert the HP Recovery media, and then restart the computer.



---

**NOTE:** HP recommends that you follow the [Restoring and recovery methods on page 64](#) to restore your computer before you obtain and use the HP recovery discs. Using a recent backup can return your machine to a working state sooner than using the HP recovery discs. After the system is restored, reinstalling all the operating system software released since your initial purchase can be a lengthy process.

---

## Changing the computer boot order

If your computer does not restart using the HP Recovery media, you can change the computer boot order, the order of devices listed in BIOS for startup information. You can select an optical drive or a USB flash drive, depending on the location of your HP Recovery media.



---

**IMPORTANT:** For a tablet with a detachable keyboard, connect the tablet to the keyboard base before beginning these steps.

---

To change the boot order:



1. Insert the HP Recovery media.
2. Access the system **Startup** menu.
  - For computers or tablets with keyboards attached, turn on or restart the computer or tablet, quickly press **esc**, and then press **f9** for boot options.
  - For tablets without keyboards, turn on or restart the tablet, quickly press and hold the volume up button, and then select **f9**.  
– or –  
Turn on or restart the tablet, quickly press and hold the volume down button, and then select **f9**.
3. Select the optical drive or USB flash drive from which you want to boot, and then follow the on-screen instructions.

## Using HP Sure Recover (select products only)

Select computer models are configured with HP Sure Recover, a PC OS recovery solution built into the hardware and software. HP Sure Recover can fully restore the HP OS image without installed recovery software.

Using HP Sure Recover, an administrator or user can restore the system and install:

- Latest version of the operating system
- Platform-specific device drivers
- Software applications, in the case of a custom image

To access the latest documentation for HP Sure Recover, go to <http://www.hp.com/support>. Follow the on-screen instructions to find your product and locate your documentation.

---

## 8 Using HP PC Hardware Diagnostics

You can use the HP PC Hardware Diagnostics utility to determine whether your computer hardware is running properly. The three versions are HP PC Hardware Diagnostics Windows, HP PC Hardware Diagnostics UEFI (Unified Extensible Firmware Interface), and (for select products only) Remote HP PC Hardware Diagnostics UEFI, a firmware feature.

### Downloading the HP PC Hardware Diagnostics Windows from the Microsoft Store

You can download the HP PC Hardware Diagnostics Windows from the Microsoft Store.

1. Select the Microsoft Store app on your desktop or enter `Microsoft Store` in the taskbar search box.
2. Enter `HP PC Hardware Diagnostics Windows` in the **Microsoft Store** search box.
3. Follow the on-screen directions.

The tool downloads to the selected location.

### Customizing Remote HP PC Hardware Diagnostics UEFI settings

Using the Remote HP PC Hardware Diagnostics setting in Computer Setup (BIOS), you can perform several customizations.

- Set a schedule for running diagnostics unattended. You can also start diagnostics immediately in interactive mode by selecting **Execute Remote HP PC Hardware Diagnostics**.
- Set the location for downloading the diagnostic tools. This feature provides access to the tools from the HP website or from a server that has been preconfigured for use. Your computer does not require the traditional local storage (such as a hard drive or USB flash drive) to run remote diagnostics.
- Set a location for storing the test results. You can also set the user name and password that you use for uploads.
- Display status information about the diagnostics run previously.

To customize Remote HP PC Hardware Diagnostics UEFI settings, follow these steps:

1. Turn on or restart the computer, and when the HP logo appears, press **F10** to enter Computer Setup.
2. Select **Advanced**, and then select **Settings**.
3. Make your customization selections.
4. Select **Main**, and then **Save Changes and Exit** to save your settings.

Your changes take effect when the computer restarts.

# 9 Specifications

This chapter provides specifications for your computer.

## Computer specifications

This section provides specifications for your computer. When traveling with your computer, the computer dimensions and weights, as well as input power ratings and operating specifications, provide helpful information.

**Table 9-1 Computer specifications**

	Metric	U.S.
<b>Dimensions</b>		
Width	<b>359.4 mm</b>	14.15 in
Depth	<b>233.95 mm</b>	9.21 in
Height	<b>19.95 mm</b>	0.79 in
<b>Weight</b>	<b>1.74 kg</b>	3.84 lbs
<b>Input power</b>		
Operating voltage and current	19.5 V dc @ 2.31 A – 45 W 19.5 V dc @ 3.33 A – 65 W	
<b>Temperature</b>		
Operating	<b>5°C to 35°C</b>	41°F to 95°F
Nonoperating	<b>-20°C to 60°C</b>	-4°F to 140°F
<b>Relative humidity</b> (noncondensing)		
Operating	10% to 90%	
Nonoperating	5% to 95%	
<b>Maximum altitude</b> (unpressurized)		
Operating	<b>-15 m to 3,048 m</b>	-50 ft to 10,000 ft
Nonoperating	<b>-15 m to 12,192 m</b>	-50 ft to 40,000 ft
<b>NOTE:</b> Applicable product safety standards specify thermal limits for plastic surfaces. The device operates well within this range of temperatures.		

## 39.6 cm (15.6 in) display specifications

This section provides specifications for your display.

**Table 9-2 Display specifications**

	<b>Metric</b>	<b>U.S.</b>
Active diagonal size	<b>39.6 cm</b>	15.6 in
Resolution	1920 × 1080 1366 × 768	
Surface treatment	Antiglare	
Brightness	250 nits (45% CG panels) 400 nits (sRGB panels) 1000 nits (72% CG)	
Viewing angle	UWVA (FHD panels) SVA (HD panels)	
Backlight	WLED	
Display panel interface	eDP	

## Solid-state drive specifications

This section provides specifications for your solid-state drives.

**Table 9-3 Solid-state drive specifications**

	<b>256 GB*</b>	<b>512 GB*</b>	<b>1 TB*</b>
<b>Dimensions</b>			
Height	1.0 mm	1.0 mm	1.0 mm
Length	50.8 mm	50.8 mm	50.8 mm
Width	28.9 mm	28.9 mm	28.9 mm
Weight	< 10 g	< 10 g	< 10 g
<b>Interface type</b>			
Ready time, maximum (to not busy)	1.0 ms	< 1.0 ms	1.0 ms
Access times, logical	0.1 ms	0.1 ms	0.1 ms
<b>Transfer rate</b>			
Sequential read	up to 2150 MB/s	up to 2150 MB/s	up to 2150 MB/s
Random read	Up to 300,000 IOPs	Up to 300,000 IOPs	Up to 300,000 IOPs
Sequential write	up to 1550 MB/s	up to 1550 MB/s	up to 1550 MB/s
Random write	Up to 100,000 IOPs	Up to 100,000 IOPs	Up to 100,000 IOPs
<b>Total logical sectors</b>	468,883,296	1,000,215,216	1,500,336,388
<b>Operating temperature</b>	<b>0°C to 70°C (32°F to 158°F)</b>		

**Table 9-3 Solid-state drive specifications (continued)**

	256 GB*	512 GB*	1 TB*
<p>*1 GB = 1 billion bytes when referring to hard drive storage capacity. Actual accessible capacity is less. Actual drive specifications might differ slightly.</p>			
<p><b>NOTE:</b> Certain restrictions and exclusions apply. Contact support for details.</p>			

---

# 10 Statement of memory volatility

For general information regarding nonvolatile memory in HP Business computers, and to restore nonvolatile memory that can contain personal data after the system has been turned off and the hard drive has been removed, use these instructions.

HP Business computer products that use Intel®-based or AMD®-based system boards contain volatile DDR memory. The amount of nonvolatile memory present in the system depends upon the system configuration. Intel-based and AMD-based system boards contain nonvolatile memory subcomponents as originally shipped from HP, with the following assumptions:

- No subsequent modifications were made to the system.
- No applications, features, or functionality were added to or installed on the system.

Following system shutdown and removal of all power sources from an HP Business computer system, personal data can remain on volatile system memory (DIMMs) for a finite period of time and also remains in nonvolatile memory. Use the following steps to remove personal data from the computer, including the nonvolatile memory found in Intel-based and AMD-based system boards.

---

 **NOTE:** If your tablet has a keyboard base, connect to the keyboard base before beginning steps in this chapter.

---

## Current BIOS steps

Use these instructions to restore nonvolatile memory.

1. Follow these steps to restore the nonvolatile memory that can contain personal data. Restoring or reprogramming nonvolatile memory that does not store personal data is neither necessary nor recommended.

- a. Turn on or restart the computer, and then quickly press `esc`.

---

 **NOTE:** If the system has a BIOS administrator password, enter the password at the prompt.

---

- b. Select **Main**, select **Apply Factory Defaults and Exit**, and then select **Yes** to load defaults. The computer restarts.

- c. During the restart, press `esc` while the "Press the ESC key for Startup Menu" message is displayed at the bottom of the screen.

---

 **NOTE:** If the system has a BIOS administrator password, enter the password at the prompt.

---

- d. Select the **Security** menu, select **Restore Security Settings to Factory Defaults**, and then select **Yes** to restore security level defaults. The computer reboots.

- e. During the reboot, press `esc` while the "Press the ESC key for Startup Menu" message is displayed at the bottom of the screen.

---

 **NOTE:** If the system has a BIOS administrator password, enter the password at the prompt.

---

- f. If an asset or ownership tag is set, select the **Security** menu and scroll down to the **Utilities** menu. Select **System IDs**, and then select **Asset Tracking Number**. Clear the tag, and then make the selection to return to the prior menu.

- g. If a DriveLock password is set, select the **Security** menu, and scroll down to **Hard Drive Utilities** under the **Utilities** menu. Select **Hard Drive Utilities**, select **DriveLock**, and then clear the check box for **DriveLock password on restart**. Select **OK** to proceed.
- h. Select the **Main** menu, and then select **Reset BIOS Security to factory default**. Select **Yes** at the warning message. The computer reboots.
- i. During the reboot, press **esc** while the "Press the ESC key for Startup Menu" message is displayed at the bottom of the screen.



**NOTE:** If the system has a BIOS administrator password, enter the password at the prompt.

- j. Select the **Main** menu, select **Apply Factory Defaults and Exit**, select **Yes** to save changes and exit, and then select **Shutdown**.
  - k. Reboot the system. If the system has a Trusted Platform Module (TPM), fingerprint reader, or both, one or two prompts will appear—one to clear the TPM and the other to Reset Fingerprint Sensor. Press or tap **f1** to accept or **f2** to reject.
  - l. Remove all power and system batteries for at least 24 hours.
2. Complete one of the following:
- Remove and retain the storage drive.  
– or –
  - Clear the drive contents by using a third-party utility designed to erase data from an SSD.  
– or –
  - Clear the contents of the drive by using the following BIOS Setup Secure Erase command option steps:

If you clear data using Secure Erase, you cannot recover it.

- a. Turn on or restart the computer, and then quickly press **esc**.
- b. Select the **Security** menu and scroll down to the **esc** menu.
- c. Select **Hard Drive Utilities**.
- d. Under **Utilities**, select **Secure Erase**, select the hard drive storing the data you want to clear, and then follow the on-screen instructions to continue.

– or –

Clear the contents of the drive using the following Disk Sanitizer commands steps:

- i. Turn on or restart the computer, and then quickly press **esc**.
- ii. Select the **Security** menu and scroll down to the **Utilities** menu.
- iii. Select **Hard Drive Utilities**.
- iv. Under **Utilities**, select **Disk Sanitizer**, select the hard drive with the data that you want to clear, and then follow the on-screen instructions to continue.



**NOTE:** The amount of time it takes for Disk Sanitizer to run can take several hours. Plug the computer into an AC outlet before starting.

# Nonvolatile memory usage

Use this table to troubleshooting nonvolatile memory usage.

**Table 10-1 Troubleshooting steps for nonvolatile memory usage**

Nonvolatile memory type	Amount (Size)	Does this memory store customer data?	Does this memory retain data when power is removed?	What is the purpose of this memory?	How is data entered into this memory?	How is this memory write-protected?
HP Sure Start flash (select models only)	8 MB	No	Yes	Provides protected backup of critical System BIOS code, EC firmware, and critical computer configuration data for select platforms that support HP Sure Start.  For more information, see <a href="#">Using HP Sure Start (select products only) on page 75</a> .	Data cannot be written to this device via the host processor. The content is managed solely by the HP Sure Start Embedded Controller.	This memory is protected by the HP Sure Start Embedded Controller.
Real Time Clock (RTC) battery backed-up CMOS configuration memory	256 bytes	No	Yes	Stores system date and time and noncritical data.	RTC battery backed-up CMOS is programmed using Computer Setup (BIOS), or by changing the Windows date & time.	This memory is not write-protected.
Controller (NIC) EEPROM	64 KB (not customer accessible)	No	Yes	Stores NIC configuration and NIC firmware.	NIC EEPROM is programmed using a utility from the NIC vendor that can be run from DOS.	A utility must be used to write data to this memory and is available from the NIC vendor. Writing data to this ROM in an inappropriate manner will render the NIC non-functional.
DIMM Serial Presence Detect (SPD) configuration data	256 bytes per memory module, 128 bytes programmable (not customer accessible)	No	Yes	Stores memory module information.	DIMM SPD is programmed by the memory vendor.	Data cannot be written to this memory when the module is installed in a computer. The specific write-protection method varies by memory vendor.
System BIOS	9 MB	Yes	Yes	Stores system BIOS code and computer configuration data.	System BIOS code is programmed at the factory. Code is updated when the system BIOS is updated. Configuration data and settings are entered using the Computer Setup (BIOS) or a custom utility.	<b>NOTE:</b> Writing data to this ROM in an inappropriate manner can render the computer non-functional.  A utility must be used for writing data to this memory and is available



**Table 10-1 Troubleshooting steps for nonvolatile memory usage (continued)**

Nonvolatile memory type	Amount (Size)	Does this memory store customer data?	Does this memory retain data when power is removed?	What is the purpose of this memory?	How is data entered into this memory?	How is this memory write-protected?
Intel Management Engine Firmware (present only in select Elite or Z models. For more information, go to <a href="http://www.hp.com/support">http://www.hp.com/support</a> . Select <b>Identify your product for manuals and specific product information</b> , and then follow the on-screen instructions.)	1.5 MB or 7 MB	Yes	Yes	Stores Management Engine Code, Settings, Provisioning Data and iAMT third-party data store.	Management Engine Code is programmed at the factory. Code is updated via Intel secure firmware update utility. Unique Provisioning Data can be entered at the factory or by an administrator using the Management Engine (MEBx) setup utility. The third-party data store contents can be populated by a remote management console or local applications that have been registered by an administrator to have access to the space.	on the HP website; go to <a href="http://www.hp.com/support">http://www.hp.com/support</a> . Select <b>Find your product</b> , and then follow the on-screen instructions.
Bluetooth flash (select products only)	2 megabits	No	Yes	Stores Bluetooth configuration and firmware.	Bluetooth flash is programmed at the factory. Tools for writing data to this memory are not publicly available but can be obtained from the silicon vendor.	A utility must be used for writing data to this memory and is made available through newer versions of the driver whenever the flash requires an upgrade.
802.11 WLAN EEPROM	4 kilobits to 8 kilobits	No	Yes	Stores configuration and calibration data.	802.11 WLAN EEPROM is programmed at the factory. Tools for writing data to this memory are not made public.	A utility must be used for writing data to this memory and is typically not made available to the public unless a firmware upgrade is necessary to address a unique issue.
Camera (select products only)	64 kilobits	No	Yes	Stores camera configuration and firmware.	Camera memory is programmed using a utility from the device manufacturer that can be run from Windows.	A utility must be used for writing data to this memory and is typically not made available to the public unless a firmware upgrade is necessary to address a unique issue.
Fingerprint reader (select products only)	512 KB flash	Yes	Yes	Stores fingerprint templates.	Fingerprint reader memory is programmed by user enrollment in HP ProtectTools Security Manager.	Only a digitally signed application can make the call to write to the flash.

## Questions and answers

Use this section to answer your questions about nonvolatile memory.

### 1. How can the BIOS settings be restored (returned to factory settings)?

 **IMPORTANT:** The restore defaults feature does not securely erase any data on your hard drive. See question and answer 6 for steps to securely erase data.

The restore defaults feature does not reset the Custom Secure Boot keys. See question and answer 7 for information about resetting the keys.

- a. Turn on or restart the computer, and then quickly press `esc`.
- b. Select **Main**, and then select **Apply Factory Defaults and Exit**.
- c. Follow the on-screen instructions.
- d. Select **Main**, select **Save Changes and Exit**, and then follow the on-screen instructions.

### 2. What is a UEFI BIOS, and how is it different from a legacy BIOS?

The Unified Extensible Firmware Interface (UEFI) BIOS is an industry-standard software interface between the platform firmware and an operating system (OS). It replaces the older BIOS architecture but supports much of the legacy BIOS functionality.

Like the legacy BIOS, the UEFI BIOS provides an interface to display the system information and configuration settings and to change the configuration of your computer before an OS is loaded. BIOS provides a secure runtime environment that supports a Graphic User Interface (GUI). In this environment, you can use either a pointing device (touch screen, touchpad, pointing stick, or USB mouse) or the keyboard to navigate and make menu and configuration selections. The UEFI BIOS also contains basic system diagnostics.

The UEFI BIOS provides functionality beyond that of the legacy BIOS. In addition, the UEFI BIOS works to initialize the computer's hardware before loading and executing the OS; the runtime environment allows the loading and execution of software programs from storage devices to provide more functionality, such as advanced hardware diagnostics (with the ability to display more detailed system information) and advanced firmware management and recovery software.

HP has provided options in Computer Setup (BIOS) to allow you to run in legacy BIOS, if required by the operating system. Examples of this requirement would be if you upgrade or downgrade the OS.

### 3. Where is the UEFI BIOS located?

The UEFI BIOS is located on a flash memory chip. You must use a utility to write to the chip.

### 4. What kind of configuration data is stored on the DIMM Serial Presence Detect (SPD) memory module? How would this data be written?

The DIMM SPD memory contains information about the memory module, such as size, serial number, data width, speed and timing, voltage, and thermal information. This information is written by the module manufacturer and stored on an EEPROM. You cannot write to this EEPROM when the memory module is installed in a computer. Third-party tools do exist that can write to the EEPROM when the memory module is not installed in a computer. Various third-party tools are available to read SPD memory.

### 5. What is meant by “Restore the nonvolatile memory found in Intel-based system boards”?

This message relates to clearing the Real Time Clock (RTC) CMOS memory that contains computer configuration data.

### 6. How can the BIOS security be reset to factory defaults and erase the data?

---

 **IMPORTANT:** Resetting results in the loss of information.

These steps do not reset Custom Secure Boot Keys. See question and answer 7 for information about resetting the keys.

---

- a. Turn on or restart the computer, and then quickly press **esc**.
- b. Select **Main**, and then select **Reset Security to Factory Defaults**.
- c. Follow the on-screen instructions.
- d. Select **Main**, select **Save Changes and Exit**, and then follow the on-screen instructions.

#### 7. How can the Custom Secure Boot Keys be reset?

Secure Boot is a feature to ensure that only authenticated code can start on a platform. If you enabled Secure Boot and created Custom Secure Boot Keys, disabling Secure Boot does not clear the keys. You must also select to clear the Custom Secure Boot Keys. Use the same Secure Boot access procedure that you used to create the Custom Secure Boot Keys, but select to clear or delete all Secure Boot Keys.

- a. Turn on or restart the computer, and then quickly press **esc**.
- b. Select the **Security** menu, select **Secure Boot Configuration**, and then follow the on-screen instructions.
- c. At the **Secure Boot Configuration** window, select **Secure Boot**, select **Clear Secure Boot Keys**, and then follow the on-screen instructions to continue.

## Using HP Sure Start (select products only)

Select computer models are configured with HP Sure Start, a technology that continuously monitors your computer's BIOS for attacks or corruption.

If the BIOS becomes corrupted or is attacked, HP Sure Start restores the BIOS to its previously safe state, without user intervention. Those select computer models ship with HP Sure Start configured and enabled. HP Sure Start is configured and already enabled so that most users can use the HP Sure Start default configuration. Advanced users can customize the default configuration.

To access the latest documentation on HP Sure Start, go to <http://www.hp.com/support>.

---

# 11 Statement of memory volatility

For general information regarding nonvolatile memory in HP Business computers, and to restore nonvolatile memory that can contain personal data after the system has been turned off and the hard drive has been removed, use these instructions.

HP Business computer products that use Intel®-based or AMD®-based system boards contain volatile DDR memory. The amount of nonvolatile memory present in the system depends upon the system configuration. Intel-based and AMD-based system boards contain nonvolatile memory subcomponents as originally shipped from HP, with the following assumptions:

- No subsequent modifications were made to the system.
- No applications, features, or functionality were added to or installed on the system.

Following system shutdown and removal of all power sources from an HP Business computer system, personal data can remain on volatile system memory (DIMMs) for a finite period of time and also remains in nonvolatile memory. Use the following steps to remove personal data from the computer, including the nonvolatile memory found in Intel-based and AMD-based system boards.

---

 **NOTE:** If your tablet has a keyboard base, connect to the keyboard base before beginning steps in this chapter.

---

## Current BIOS steps

Use these instructions to restore nonvolatile memory.

1. Follow these steps to restore the nonvolatile memory that can contain personal data. Restoring or reprogramming nonvolatile memory that does not store personal data is neither necessary nor recommended.

- a. Turn on or restart the computer, and then quickly press `esc`.

---

 **NOTE:** If the system has a BIOS administrator password, enter the password at the prompt.

---

- b. Select **Main**, select **Apply Factory Defaults and Exit**, and then select **Yes** to load defaults. The computer restarts.

- c. During the restart, press `esc` while the "Press the ESC key for Startup Menu" message is displayed at the bottom of the screen.

---

 **NOTE:** If the system has a BIOS administrator password, enter the password at the prompt.

---

- d. Select the **Security** menu, select **Restore Security Settings to Factory Defaults**, and then select **Yes** to restore security level defaults. The computer reboots.

- e. During the reboot, press `esc` while the "Press the ESC key for Startup Menu" message is displayed at the bottom of the screen.

---

 **NOTE:** If the system has a BIOS administrator password, enter the password at the prompt.

---

- f. If an asset or ownership tag is set, select the **Security** menu and scroll down to the **Utilities** menu. Select **System IDs**, and then select **Asset Tracking Number**. Clear the tag, and then make the selection to return to the prior menu.

- g.** If a DriveLock password is set, select the **Security** menu, and scroll down to **Hard Drive Utilities** under the **Utilities** menu. Select **Hard Drive Utilities**, select **DriveLock**, and then clear the check box for **DriveLock password on restart**. Select **OK** to proceed.
  - h.** Select the **Main** menu, and then select **Reset BIOS Security to factory default**. Select **Yes** at the warning message. The computer reboots.
  - i.** During the reboot, press **esc** while the "Press the ESC key for Startup Menu" message is displayed at the bottom of the screen.
- 
-  **NOTE:** If the system has a BIOS administrator password, enter the password at the prompt.
- j.** Select the **Main** menu, select **Apply Factory Defaults and Exit**, select **Yes** to save changes and exit, and then select **Shutdown**.
  - k.** Reboot the system. If the system has a Trusted Platform Module (TPM), fingerprint reader, or both, one or two prompts will appear—one to clear the TPM and the other to Reset Fingerprint Sensor. Press or tap **f1** to accept or **f2** to reject.
  - l.** Remove all power and system batteries for at least 24 hours.

**2.** Complete one of the following:

- Remove and retain the storage drive.

– or –
- Clear the drive contents by using a third-party utility designed to erase data from an SSD.

– or –
- Clear the contents of the drive by using the following BIOS Setup Secure Erase command option steps:

If you clear data using Secure Erase, you cannot recover it.

- a.** Turn on or restart the computer, and then quickly press **esc**.
- b.** Select the **Security** menu and scroll down to the **esc** menu.
- c.** Select **Hard Drive Utilities**.
- d.** Under **Utilities**, select **Secure Erase**, select the hard drive storing the data you want to clear, and then follow the on-screen instructions to continue.

– or –

Clear the contents of the drive using the following Disk Sanitizer commands steps:

- i.** Turn on or restart the computer, and then quickly press **esc**.
- ii.** Select the **Security** menu and scroll down to the **Utilities** menu.
- iii.** Select **Hard Drive Utilities**.
- iv.** Under **Utilities**, select **Disk Sanitizer**, select the hard drive with the data that you want to clear, and then follow the on-screen instructions to continue.

---

 **NOTE:** The amount of time it takes for Disk Sanitizer to run can take several hours. Plug the computer into an AC outlet before starting.

---

# Nonvolatile memory usage

Use this table to troubleshooting nonvolatile memory usage.

**Table 11-1 Troubleshooting steps for nonvolatile memory usage**

Nonvolatile memory type	Amount (Size)	Does this memory store customer data?	Does this memory retain data when power is removed?	What is the purpose of this memory?	How is data entered into this memory?	How is this memory write-protected?
HP Sure Start flash (select models only)	8 MB	No	Yes	Provides protected backup of critical System BIOS code, EC firmware, and critical computer configuration data for select platforms that support HP Sure Start.  For more information, see <a href="#">Using HP Sure Start (select products only) on page 75</a> .	Data cannot be written to this device via the host processor. The content is managed solely by the HP Sure Start Embedded Controller.	This memory is protected by the HP Sure Start Embedded Controller.
Real Time Clock (RTC) battery backed-up CMOS configuration memory	256 bytes	No	Yes	Stores system date and time and noncritical data.	RTC battery backed-up CMOS is programmed using Computer Setup (BIOS), or by changing the Windows date & time.	This memory is not write-protected.
Controller (NIC) EEPROM	64 KB (not customer accessible)	No	Yes	Stores NIC configuration and NIC firmware.	NIC EEPROM is programmed using a utility from the NIC vendor that can be run from DOS.	A utility must be used to write data to this memory and is available from the NIC vendor. Writing data to this ROM in an inappropriate manner will render the NIC non-functional.
DIMM Serial Presence Detect (SPD) configuration data	256 bytes per memory module, 128 bytes programmable (not customer accessible)	No	Yes	Stores memory module information.	DIMM SPD is programmed by the memory vendor.	Data cannot be written to this memory when the module is installed in a computer. The specific write-protection method varies by memory vendor.
System BIOS	9 MB	Yes	Yes	Stores system BIOS code and computer configuration data.	System BIOS code is programmed at the factory. Code is updated when the system BIOS is updated. Configuration data and settings are entered using the Computer Setup (BIOS) or a custom utility.	<b>NOTE:</b> Writing data to this ROM in an inappropriate manner can render the computer non-functional.  A utility must be used for writing data to this memory and is available

**Table 11-1 Troubleshooting steps for nonvolatile memory usage (continued)**

Nonvolatile memory type	Amount (Size)	Does this memory store customer data?	Does this memory retain data when power is removed?	What is the purpose of this memory?	How is data entered into this memory?	How is this memory write-protected?
Intel Management Engine Firmware (present only in select Elite or Z models. For more information, go to <a href="http://www.hp.com/support">http://www.hp.com/support</a> . Select <b>Identify your product for manuals and specific product information</b> , and then follow the on-screen instructions.)	1.5 MB or 7 MB	Yes	Yes	Stores Management Engine Code, Settings, Provisioning Data and iAMT third-party data store.	Management Engine Code is programmed at the factory. Code is updated via Intel secure firmware update utility. Unique Provisioning Data can be entered at the factory or by an administrator using the Management Engine (MEBx) setup utility. The third-party data store contents can be populated by a remote management console or local applications that have been registered by an administrator to have access to the space.	on the HP website; go to <a href="http://www.hp.com/support">http://www.hp.com/support</a> . Select <b>Find your product</b> , and then follow the on-screen instructions.
Bluetooth flash (select products only)	2 megabits	No	Yes	Stores Bluetooth configuration and firmware.	Bluetooth flash is programmed at the factory. Tools for writing data to this memory are not publicly available but can be obtained from the silicon vendor.	A utility must be used for writing data to this memory and is made available through newer versions of the driver whenever the flash requires an upgrade.
802.11 WLAN EEPROM	4 kilobits to 8 kilobits	No	Yes	Stores configuration and calibration data.	802.11 WLAN EEPROM is programmed at the factory. Tools for writing data to this memory are not made public.	A utility must be used for writing data to this memory and is typically not made available to the public unless a firmware upgrade is necessary to address a unique issue.
Camera (select products only)	64 kilobits	No	Yes	Stores camera configuration and firmware.	Camera memory is programmed using a utility from the device manufacturer that can be run from Windows.	A utility must be used for writing data to this memory and is typically not made available to the public unless a firmware upgrade is necessary to address a unique issue.
Fingerprint reader (select products only)	512 KB flash	Yes	Yes	Stores fingerprint templates.	Fingerprint reader memory is programmed by user enrollment in HP ProtectTools Security Manager.	Only a digitally signed application can make the call to write to the flash.

## Questions and answers

Use this section to answer your questions about nonvolatile memory.

### 1. How can the BIOS settings be restored (returned to factory settings)?



**IMPORTANT:** The restore defaults feature does not securely erase any data on your hard drive. See question and answer 6 for steps to securely erase data.

The restore defaults feature does not reset the Custom Secure Boot keys. See question and answer 7 for information about resetting the keys.

- a. Turn on or restart the computer, and then quickly press `esc`.
- b. Select **Main**, and then select **Apply Factory Defaults and Exit**.
- c. Follow the on-screen instructions.
- d. Select **Main**, select **Save Changes and Exit**, and then follow the on-screen instructions.

### 2. What is a UEFI BIOS, and how is it different from a legacy BIOS?

The Unified Extensible Firmware Interface (UEFI) BIOS is an industry-standard software interface between the platform firmware and an operating system (OS). It replaces the older BIOS architecture but supports much of the legacy BIOS functionality.

Like the legacy BIOS, the UEFI BIOS provides an interface to display the system information and configuration settings and to change the configuration of your computer before an OS is loaded. BIOS provides a secure runtime environment that supports a Graphic User Interface (GUI). In this environment, you can use either a pointing device (touch screen, touchpad, pointing stick, or USB mouse) or the keyboard to navigate and make menu and configuration selections. The UEFI BIOS also contains basic system diagnostics.

The UEFI BIOS provides functionality beyond that of the legacy BIOS. In addition, the UEFI BIOS works to initialize the computer's hardware before loading and executing the OS; the runtime environment allows the loading and execution of software programs from storage devices to provide more functionality, such as advanced hardware diagnostics (with the ability to display more detailed system information) and advanced firmware management and recovery software.

HP has provided options in Computer Setup (BIOS) to allow you to run in legacy BIOS, if required by the operating system. Examples of this requirement would be if you upgrade or downgrade the OS.

### 3. Where is the UEFI BIOS located?

The UEFI BIOS is located on a flash memory chip. You must use a utility to write to the chip.

### 4. What kind of configuration data is stored on the DIMM Serial Presence Detect (SPD) memory module? How would this data be written?

The DIMM SPD memory contains information about the memory module, such as size, serial number, data width, speed and timing, voltage, and thermal information. This information is written by the module manufacturer and stored on an EEPROM. You cannot write to this EEPROM when the memory module is installed in a computer. Third-party tools do exist that can write to the EEPROM when the memory module is not installed in a computer. Various third-party tools are available to read SPD memory.

### 5. What is meant by “Restore the nonvolatile memory found in Intel-based system boards”?

This message relates to clearing the Real Time Clock (RTC) CMOS memory that contains computer configuration data.

### 6. How can the BIOS security be reset to factory defaults and erase the data?



---

 **IMPORTANT:** Resetting results in the loss of information.

These steps do not reset Custom Secure Boot Keys. See question and answer 7 for information about resetting the keys.

---

- a. Turn on or restart the computer, and then quickly press **esc**.
- b. Select **Main**, and then select **Reset Security to Factory Defaults**.
- c. Follow the on-screen instructions.
- d. Select **Main**, select **Save Changes and Exit**, and then follow the on-screen instructions.

#### 7. How can the Custom Secure Boot Keys be reset?

Secure Boot is a feature to ensure that only authenticated code can start on a platform. If you enabled Secure Boot and created Custom Secure Boot Keys, disabling Secure Boot does not clear the keys. You must also select to clear the Custom Secure Boot Keys. Use the same Secure Boot access procedure that you used to create the Custom Secure Boot Keys, but select to clear or delete all Secure Boot Keys.

- a. Turn on or restart the computer, and then quickly press **esc**.
- b. Select the **Security** menu, select **Secure Boot Configuration**, and then follow the on-screen instructions.
- c. At the **Secure Boot Configuration** window, select **Secure Boot**, select **Clear Secure Boot Keys**, and then follow the on-screen instructions to continue.

## Using HP Sure Start (select products only)

Select computer models are configured with HP Sure Start, a technology that continuously monitors your computer's BIOS for attacks or corruption.

If the BIOS becomes corrupted or is attacked, HP Sure Start restores the BIOS to its previously safe state, without user intervention. Those select computer models ship with HP Sure Start configured and enabled. HP Sure Start is configured and already enabled so that most users can use the HP Sure Start default configuration. Advanced users can customize the default configuration.

To access the latest documentation on HP Sure Start, go to <http://www.hp.com/support>.

# 12 Power cord set requirements

This chapter provides power cord requirements for countries and regions.

The wide-range input feature of the computer permits it to operate from any line voltage from 100 V ac to 120 V ac, or from 220 V ac to 240 V ac.

The 3-conductor power cord set included with the computer meets the requirements for use in the country or region where the equipment is purchased.

Power cord sets for use in other countries or regions must meet the requirements of the country and region where the computer is used.

## Requirements for all countries

These power cord requirements are applicable to all countries and regions.

- The length of the power cord set must be at least **1.0 m** (3.3 ft) and no more than **2.0 m** (6.5 ft).
- All power cord sets must be approved by an acceptable accredited agency responsible for evaluation in the country or region where the power cord set will be used.
- The power cord sets must have a minimum current capacity of 10 A and a nominal voltage rating of 125 V ac or 250 V ac, as required by the power system of each country or region.
- The appliance coupler must meet the mechanical configuration of an EN 60 320/IEC 320 Standard Sheet C13 connector for mating with the appliance inlet on the back of the computer.

## Requirements for specific countries and regions

To determine power cord requirements for specific countries and regions, use this table.

**Table 12-1 Power cord requirements for specific countries and regions**

Country/region	Accredited agency	Applicable note number
Argentina	IRAM	1
Australia	SAA	1
Austria	OVE	1
Belgium	CEBEC	1
Brazil	ABNT	1
Canada	CSA	2
Chile	IMQ	1
Denmark	DEMKO	1
Finland	FIMKO	1
France	UTE	1
Germany	VDE	1

**Table 12-1 Power cord requirements for specific countries and regions (continued)**

Country/region	Accredited agency	Applicable note number
India	BIS	1
Israel	SII	1
Italy	IMQ	1
Japan	JIS	3
The Netherlands	KEMA	1
New Zealand	SANZ	1
Norway	NEMKO	1
The People's Republic of China	CCC	4
Saudi Arabia	SASO	7
Singapore	PSB	1
South Africa	SABS	1
South Korea	KTL	5
Sweden	SEMKO	1
Switzerland	SEV	1
Taiwan	BSMI	6
Thailand	TISI	1
The United Kingdom	ASTA	1
The United States	UL	2

1. The flexible cord must be Type H05VV-F, 3-conductor, 0.75 mm<sup>2</sup> conductor size. Power cord set fittings (appliance coupler and wall plug) must bear the certification mark of the agency responsible for evaluation in the country or region where it will be used.
2. The flexible cord must be Type SVT/SJT or equivalent, No. 18 AWG, 3-conductor. The wall plug must be a two-pole grounding type with a NEMA 5-15P (15 A, 125 V ac) or NEMA 6-15P (15 A, 250 V ac) configuration. CSA or C-UL mark. UL file number must be on each element.
3. The appliance coupler, flexible cord, and wall plug must bear a T mark and registration number in accordance with the Japanese Dentori Law. The flexible cord must be Type VCTF, 3-conductor, 0.75 mm<sup>2</sup> or 1.25 mm<sup>2</sup> conductor size. The wall plug must be a two-pole grounding type with a Japanese Industrial Standard C8303 (7 A, 125 V ac) configuration.
4. The flexible cord must be Type RVV, 3-conductor, 0.75 mm<sup>2</sup> conductor size. Power cord set fittings (appliance coupler and wall plug) must bear the CCC certification mark.
5. The flexible cord must be Type H05VV-F 3-conductor, 0.75 mm<sup>2</sup> conductor size. KTL logo and individual approval number must be on each element. Approval number and logo must be printed on a flag label.
6. The flexible cord must be Type HVCTF 3-conductor, 1.25 mm<sup>2</sup> conductor size. Power cord set fittings (appliance coupler, cable, and wall plug) must bear the BSMI certification mark.
7. For 127 V ac, the flexible cord must be Type SVT or SJT 3-conductor, 18 AWG, with plug NEMA 5-15P (15 A, 125 V ac), with UL and CSA or C-UL marks. For 240 V ac, the flexible cord must be Type H05VV-F 3-conductor, 0.75 mm<sup>2</sup> or 1.00 mm<sup>2</sup> conductor size, with plug BS 1363/A with BSI or ASTA marks.

---

# 13 Recycling

When a nonrechargeable or rechargeable battery has reached the end of its useful life, do not dispose of the battery in general household waste. Follow the local laws and regulations in your area for battery disposal.

HP encourages customers to recycle used electronic hardware, HP original print cartridges, and rechargeable batteries. For more information about recycling programs, see the HP website at <http://www.hp.com/recycle>.

# Index

## A

- AC adapters, spare part numbers 22
- action keys
  - programmable key 13
  - touchpad 13
- audio-out (headphone)/audio-in (microphone) combo jack, identifying 6

## B

- backup, creating 63
- backups 63
- battery light 6
- BIOS
  - determining version 60
  - downloading an update 60, 61
  - updating 60
- Bluetooth label 15
- boot order
  - changing using the f9 prompt 61
- boot order, changing 64
- bottom 15
- bottom cover
  - removal 30
  - spare part number 30
- buttons
  - power 11, 13

## C

- Cable Kit
  - spare part number 22
- camera 8
  - identifying 8
- camera light, identifying 8
- camera privacy cover, identifying 8
- caps lock light, identifying 10
- cautions
  - electrostatic discharge 25, 26
- components
  - bottom 14
  - display 8
  - keyboard area 9
  - left side 7

- rear 15
- right side 6
- computer major components 18
- Computer Setup
  - navigating and selecting 59
  - restoring factory settings 59
  - starting 59
- computer specifications 67
- connector, power 6
- control zone 10

## D

- display
  - specifications 67
- display assembly
  - subcomponents 20
- display back cover
  - illustrated 20
  - spare part number 20
- display bezel
  - illustrated 20
  - spare part number 20
- display cable
  - illustrated 20
  - spare part number 20
- display components 8
- display panel
  - illustrated 20
  - spare part number 20
- DisplayPort, identifying USB Type-C 6

## E

- electrostatic discharge (ESD) 25, 26
  - preventing damage 25, 26, 27
- esc key, identifying 13

## F

- fan
  - removal 41
  - spare part number 41
- fingerprint reader board
  - removal 42
  - spare part numbers 42
- fingerprint reader, identifying 11

- fn key, identifying 13
- fn lock light, identifying 10

## G

- grounding methods 25, 26, 28
- guidelines
  - packaging 25, 29
  - transporting 25, 29
  - workstation 25, 26

## H

- hard drive
  - specifications 67
- heat sink
  - removal 43
  - spare part numbers 43
- hinge
  - illustrated 20
  - spare part number 20
- hot keys
  - using 14
- HP PC Hardware Diagnostics Windows
  - downloading 66
- HP Recovery media
  - recovery 64
- HP Sure Recover 65
- HP Sure Start 70, 75, 76, 81

## I

- I/O board
  - removal 39
  - spare part number 39
- illustrated parts catalog 18
- integrated numeric keypad, identifying 13
- internal microphones, identifying 8

## J

- jacks
  - audio-out (headphone)/audio-in (microphone) combo 6
  - network 7
  - RJ-45 (network) 7

- K**
- keyboard
  - product description 3
- keypad
  - integrated numeric 13
- keys
  - esc 13
  - fn 13
  - num lk 13
  - Windows 13
  - Windows application 13
- L**
- labels
  - Bluetooth 15
  - regulatory 15
  - serial number 15
  - service 15
  - wireless certification 15
  - WLAN 15
- left control zone, identifying 10
- left side components 7
- lights
  - AC adapter and battery 6
  - battery 6
  - camera 8
  - caps lock 10
  - fn lock 10
  - microphone mute 10
  - num lk 10
  - power 10
  - privacy key 10
  - RJ-45 (network) 7
- M**
- media card reader
  - product description 3
- memory
  - nonvolatile 70, 76
  - volatile 70, 76
- memory modules
  - removal 33
  - spare part numbers 33
- microphone mute light, identifying 10
- microSD memory card reader, identifying 6
- N**
- network jack, identifying 7
- nonvolatile memory 70, 76
- num lk light 10
- P**
- packaging guidelines 25, 29
- Plastics Kit, spare part number 22
- pointing device, product description 3
- ports
  - product description 3
  - USB port with HP Sleep and Charge 6
  - USB powered 6
  - USB SuperSpeed 6
  - USB SuperSpeed port with HP Sleep and Charge 6
  - USB Type-C 6
  - USB Type-C DisplayPort 6
  - USB Type-C power connector 6
  - USB Type-C power connector and port 6
  - USB Type-C power connector and port with HP Sleep and Charge 6
  - USB Type-C power connector and SuperSpeed Plus port 6
  - USB Type-C power connector and SuperSpeed port 6
  - USB Type-C SuperSpeed 6
  - USB Type-C SuperSpeed Plus with HP Sleep and Charge 6
  - USB Type-C SuperSpeed with HP Sleep and Charge 6
  - USB Type-C with HP Sleep and Charge 6
- power button, identifying 11, 13
- power connector
  - identifying 6
  - identifying USB Type-C 6
- power connector cable
  - removal 49
  - spare part number 49
- power cord
  - requirements for all countries 82
  - requirements for specific countries and regions 82
  - set requirements 82
- power cords, spare part numbers 22
- power lights 10
- privacy key light 10
- product description
  - keyboard 3
  - media card reader 3
  - pointing device 3
  - ports 3
  - sensors 3
- product name and number, computer 15
- R**
- recovery 63
  - discs 64
  - media 64
  - USB flash drive 64
- recovery media 63
  - creating using HP Cloud Recovery Download Tool 63
  - creating using Windows tools 63
- regulatory information
  - regulatory label 15
  - wireless certification labels 15
- Remote HP PC Hardware Diagnostics UEFI settings
  - customizing 66
- removal and replacement
  - procedures 30
  - solid-state drive 38
- removing personal data from volatile system memory 70, 76
- restoring 63
- right control zone, identifying 10
- right side components 6
- RJ-45 (network) jack, identifying 7
- RJ-45 (network) lights, identifying 7
- Rubber Kit, spare part number 22
- S**
- Screw Kit, spare part number 22
- security cable slot, identifying 7
- sensors
  - product description 3
  - serial number, computer 15
  - service labels, locating 15
- setup utility
  - navigating and selecting 59
  - restoring factory settings 59
- slots
  - security cable 7

- solid-state drive
  - removal and replacement 38
  - specifications 68
- spare part country codes 57
- speakers
  - removal 48
  - spare part numbers 48
- speakers, identifying 11
- special keys, using 13
- specifications
  - computer 67
  - display 67
  - hard drive 67
  - solid-state drive 68
- static electricity 25, 26, 27
- Sure Start
  - using 62
- system board
  - removal 45
  - spare part numbers 45
- system memory, removing personal data from volatile 70, 76
- system restore 64
- system restore point, creating 63

**T**

- top cover with keyboard
  - spare part numbers 57
- touchpad
  - removal 40
  - settings 9, 10
  - spare part number 40
- touchpad zone, identifying 10
- TPM settings 61
- transporting guidelines 25, 29
- traveling with the computer 15

**U**

- USB port with HP Sleep and Charge, identifying 6
- USB powered port, identifying 6
- USB SuperSpeed port with HP Sleep and Charge, identifying 6
- USB SuperSpeed port, identifying 6
- USB SuperSpeed powered port, identifying 6
- USB Type-C port with HP Sleep and Charge, identifying 6
- USB Type-C port, identifying 6

- USB Type-C power connector and port with HP Sleep and Charge, identifying 6
- USB Type-C power connector and port, identifying 6
- USB Type-C power connector and SuperSpeed Plus port, identifying 6
- USB Type-C power connector and SuperSpeed port, identifying 6
- USB Type-C power connector port, identifying 6
- USB Type-C SuperSpeed Plus port with HP Sleep and Charge, identifying 6
- USB Type-C SuperSpeed port with HP Sleep and Charge, identifying 6
- USB Type-C SuperSpeed port, identifying 6

**V**

- vents, identifying 14, 15

**W**

- Windows
  - backup 63
  - recovery media 63
  - system restore point 63
- Windows application key, identifying 13
- Windows key, identifying 13
- Windows tools, using 63
- wireless antennas
  - illustrated 20
  - spare part number 20
- wireless antennas, identifying 8
- wireless certification label 15
- WLAN antennas, identifying 8
- WLAN device 15
- WLAN label 15
- WLAN module
  - removal 34
  - spare part numbers 34
- workstation guidelines 25, 26
- WWAN antennas, identifying 8
- WWAN module
  - removal 36
  - spare part numbers 36