



HP DesignJet T850 Printer Series
HP DesignJet T950 Printer Series
User Guide

SUMMARY

Instructions on installing, using, and troubleshooting printer hardware and software.

Legal information

© Copyright 2024 HP Development Company, L.P.

Edition 3

Legal notices

The information contained herein is subject to change without notice.

The only warranties for HP products and services are set forth in the express warranty statement accompanying such products and services. Nothing herein should be construed as constituting an additional warranty. HP shall not be liable for technical or editorial errors or omissions contained herein.



IPv6-ready



Wi-Fi certified

Trademarks

Adobe®, Acrobat®, and Adobe Photoshop® are trademarks of Adobe Systems Incorporated.

ENERGY STAR and the ENERGY STAR mark are registered U.S. trademarks.

Microsoft® and Windows® are U.S. registered trademarks of Microsoft Corporation.

Apple and AirPrint are trademarks of Apple Inc., registered in the U.S. and other countries.

Table of contents

1 Introduction	1
Safety precautions	1
Using this guide	4
Printer models	5
Main features	5
Main components	6
Installing the HP DesignJet T850/T850 MFP printer	8
Installing the HP DesignJet T950/T950 MFP printer	8
Turn the printer on and off	9
Control panel	9
Printer solutions	11
Mobile printing	13
Reports	13
2 Connecting the printer	15
Choose which connection method to use	15
Connect the printer to your network	18
Set up your device	18
3 Setting up the printer	19
Introduction	19
Accessibility	19
Change the language of the control-panel display	19
Access the Embedded Web Server	19
Change the language of the Embedded Web Server	20
Automatic firmware update	20
Set Windows driver preferences	20
Energy-conservation settings	20
Change the control-panel display brightness	22
Configure network settings	22
Configure firewall settings	23
4 Paper handling	26
General paper-loading advice	26
Load a roll onto the spindle	26
Load a roll into the printer	28

Unload a roll.....	29
Use the tray (HP DesignJet T850).....	29
Use the tray (HP DesignJet T950)	30
Load a single sheet.....	31
Unload a single sheet.....	32
Use the stacker (HP DesignJet T950)	32
Use the sheet organizer (HP DesignJet T950).....	35
View information about the paper	35
Maintain paper	36
Change the drying time.....	36
Turn the automatic cutter on and off.....	36
Advance button and cut button.....	37
5 Printing.....	38
Easy printing with HP Click.....	38
Printing from an application using a printer driver.....	38
Print from USB flash drive	43
Print using Wi-Fi Direct	43
Mobile printing	45
6 Scanning (only MFP).....	50
Quick Sets.....	50
Paper types suitable for scanning	52
Scan widget	53
Scan destinations	53
Scan settings.....	56
Scan options setup process.....	57
Scan from the HP app	64
Web scan	64
Scanning to the network folder using the widget.....	64
7 Copying (only MFP).....	66
Copy.....	66
Copy widget	67
Copy settings.....	68
8 Quick Sets.....	70
Factory Quick Sets	70
Managing Quick Sets.....	70
Creating a new Quick Set	70
Editing a Quick Set.....	72

Deleting a Quick Set	72
Copying a Quick Set.....	72
Viewing a Quick Set.....	73
Launching Quick Sets.....	73
9 Practical printing examples.....	75
Print a draft for revision with the correct scale	75
Print a PDF multipage job from Adobe Acrobat Reader or Adobe Acrobat Pro	76
Print a document with the correct colors	76
Print a project using Autodesk AutoCAD	80
Print a presentation.....	82
10 Handling ink cartridges and printhead.....	85
About the ink cartridges	85
Store supply usage data	85
Check ink cartridge status.....	86
Replace an ink cartridge.....	86
About the printhead	87
Safe mode.....	87
11 Maintaining the printer.....	88
Check printer status.....	88
Take care of the printer	88
Clean the exterior of the printer	88
Print Quality Diagnostic Report.....	88
Clean the printhead	89
Align the printhead.....	90
Replace the printhead.....	90
Cannot connect the tubes to the printhead.....	93
Clean the encoder strip	94
Recalibrate the paper advance.....	94
Clean the scanner scanbars.....	95
Calibrate the scanner.....	97
Move or store the printer.....	98
Firmware update	98
Automatic firmware updates	98
Manual firmware updates (only MFP).....	99
Manual firmware updates (only non-MFP).....	99
Software update.....	99
Printer maintenance kits	99

12 Accessories	100
How to order supplies and accessories	100
Introduction to the accessories.....	101
13 Troubleshooting paper issues	104
Paper cannot be loaded successfully	104
Paper type is not in the driver or control panel	106
Printer printed on the wrong paper type.....	107
Paper mismatch.....	108
Cut-sheet doesn't enter or drops out of the sheet organizer.....	108
Roll has jammed.....	108
Tray has jammed (only HP DesignJet T850).....	109
Tray has jammed (HP DesignJet T950).....	110
A single sheet has jammed	112
The paper has jammed in the scanner	113
A strip stays on the output area and generates jams.....	115
How to remove jams	115
Printer displays out of paper when paper is available	116
Prints do not fall neatly into the bin.....	116
Change stacker from default to regular bin style configuration.....	116
Sheet stays in the printer when the print has been completed.....	119
Paper is cut when the print has been completed.....	119
Cutter does not cut well	119
Scanner does not load original.....	120
Cannot connect the tubes to the printhead.....	120
14 Troubleshooting print-quality issues	121
General printing advice	121
Horizontal lines across the image (banding)	121
Lines are too thick, too thin, or missing.....	122
Lines appear stepped or jagged.....	122
Lines print double or in the wrong colors	123
Lines are discontinuous.....	123
Lines are blurred.....	124
Line lengths are inaccurate.....	124
Whole image is blurry or grainy	125
Paper is not flat	125
Print is scuffed or scratched.....	126
Ink marks on the paper	126

Black ink comes off when you touch the print.....	127
Edges of objects are stepped or not sharp	127
Edges of objects are darker than expected	128
Vertical lines of different colors	128
White spots on the print.....	128
Colors are inaccurate.....	128
Colors are fading.....	129
Image is incomplete (clipped at the bottom)	129
Image is clipped	129
Some objects are missing from the printed image	130
How to avoid further issues	130
15 Troubleshooting scanner issues	131
Cannot access the network folder	131
Scanning to file is slow.....	131
Original document is reloaded while scanning.....	132
16 Troubleshooting copy and scan quality issues (only MFP).....	134
Random vertical lines	134
Wrinkles or folds.....	135
Line discontinuities.....	135
Light-colored area fills are missing in the scan or copy	136
Grain in area fills when scanning plain paper	137
Small color differences between adjacent scanbars	138
Vertical light lines at the intersection between scanner scanbars	139
Variable line thickness or missing lines.....	140
Inaccurately reproduced colors.....	140
Color fringing	141
Clipping in dark or light areas	142
Flare in the image when scanning glossy originals	143
Vertical red and green bands over white or black background	143
Vibration	143
Defocus, blurring and fading colors.....	144
Incorrect paper advance, skew during scanning, or horizontal wrinkles.....	145
Vertical black band 30 cm wide.....	146
The scanner damages some originals	147
Completely wrong colors	147
Vertical distortion	148
Object replication (ghosting)	148

Clipping or incorrect scale factor when down-scaling in copies and prints	149
Incorrect edge detection, mostly when scanning tracing paper	149
A copied or scanned image is very skewed	150
17 The scanner diagnostic plot.....	151
Prepare the printer and the paper to print the diagnostic sheet.....	151
Visual check for errors while printing the diagnostic sheet.....	151
Scan or copy the diagnostic plot.....	155
Monitor calibration.....	155
Save the diagnostic plot for future use	156
18 Troubleshooting ink cartridge and printhead issues	157
Cannot insert an ink cartridge	157
Ink cartridge status messages.....	157
Cannot insert the printhead	157
19 Troubleshooting data communication issues	158
Communication failures between computer and printer	158
Wired network issues	159
Wireless network issues.....	160
Mobile Printing issues	163
Network configuration page.....	163
20 Troubleshooting general printer issues	165
Printer does not start.....	165
Printer does not print	165
Printer seems slow	165
Control panel is frozen.....	166
Cannot access the Embedded Web Server	166
Restore factory defaults and settings.....	166
Alerts.....	167
21 Control-panel error messages	168
Text messages and numerical error codes.....	168
22 HP Customer Care.....	173
Introduction.....	173
HP Professional Services	173
Customer Self Repair	174
Contact HP Support.....	175
23 Printer specifications	176
Functional specifications	176

Physical specifications.....	177
Memory specifications	178
Power specifications.....	178
Ecological specifications.....	178
Environmental specifications.....	178
Acoustic specifications	179
Glossary.....	180
Index.....	183

1 Introduction

Essential safety precautions and an overview of the printer's main features, components, software options and printing possibilities.

Safety precautions

Ensure proper use of the printer to prevent it from being damaged.

Read these safety precautions before using your printer. Also read your local Environmental, Health, and Safety regulations.

This equipment is not suitable for use in locations where children are likely to be present.

For any maintenance or part replacement, follow the instructions provided in HP documentation to minimize safety risks and to avoid damaging the printer.

Follow these general safety precautions at all times:

- Use the power supply voltage specified on the label. Avoid overloading the printer's electrical outlet with multiple devices
- Do not disassemble or repair the printer yourself. Contact your local HP Service Representative for service, see [HP Support Center on page 173](#)
- Use only the electrical cord supplied by HP with the printer. Do not damage, cut, or repair the power cord. A damaged power cord can cause fire or electric shock. Replace a damaged power cord with an HP-approved power cord
- Do not operate the printer with covers bypassed
- Beware that a paper roll does not drop onto your feet or trap your hand and fingers during the paper roll load/unload process
- Do not allow metal or liquids (except those used in HP Cleaning Kits) to touch the internal parts of the printer. Doing so may cause fire, electric shock, or other serious hazards
- Power off the printer and unplug the power cord from the power outlet then call your service representative in any of the following cases:
 - When placing your hands inside the printer
 - If there is smoke or an unusual smell coming from the printer
 - If the printer is making an unusual noise not heard during normal operation
 - A piece of metal or a liquid (not part of cleaning and maintenance routines) touches internal parts of the printer
 - The printer has been dropped.
 - During an electrical storm (thunder and lightning)
 - During a power failure

- To avoid being pinched, keep your fingers away from the gap between the bottom of the printer and the stand while you're moving the printer with stand
- Before servicing the printer

Electrical shock hazard

This topic explains the concepts involved in this subject.

⚠ WARNING! The internal circuits of the built-in power supplies and power inlet operate at hazardous voltages capable of causing death or serious personal injury.

Unplug the printer's power cord before servicing the printer.

The printer requires a building installation circuit breaker, which must meet the requirements of the printer and should be in accordance with the Electrical Code requirements of the local jurisdiction of the country in which the equipment is installed.

To avoid the risk of electric shock:

- The printer should be connected to earthed mains outlets only.
- Avoid overloading the printer's electrical outlet with multiple devices.
- Do not remove or open any closed system covers or plugs.
- Do not insert objects through slots in the printer.
- Take care not to trip over the cables when walking behind the printer.
- Insert the power cord securely and completely into the wall socket and printer inlet.
- Never handle the power cord with wet hands.

Fire hazard

This topic explains the concepts involved in this subject.

To avoid the risk of fire, take the following precautions:

- The customer is responsible for meeting the printer's requirements and the Electrical Code requirements according to the local jurisdiction of the country where the printer is installed. Use the power supply voltage specified on the nameplate.
- Use only the power cord supplied by HP with the printer. Do not use a damaged power cord. Do not use the power cord with other products.
- Do not insert objects through slots in the printer.
- Take care not to spill liquid on the printer. After cleaning, make sure all components are dry before using the printer again.
- Do not use aerosol products that contain flammable gases inside or around the printer. Do not operate the printer in an explosive atmosphere.
- Do not block or cover the openings of the printer.

Mechanical hazard

This topic explains the concepts involved in this subject.

The printer has moving parts that could cause injury. To avoid personal injury, take the following precautions when working close to the printer.

- Keep your clothing and all parts of your body away from moving parts.
- Avoid wearing necklaces, bracelets, and other hanging objects.
- If your hair is long, try to secure it so that it will not fall into the printer.
- Take care that sleeves or gloves do not get caught in moving parts.
- Do not operate the printer with covers bypassed.
- If you need to replace the cutter assembly, take care not to cut yourself on the sharp cutting edge.
- Internal fan blades are hazardous moving parts. Disconnect the printer before servicing.
- Never insert your hands into the printer while it is printing, due to the moving parts inside.

Ink handling

HP recommends that you wear gloves when handling ink supplies.

USA Safety for Products containing Button Cell or Coin Batteries

⚠ WARNING	
<ul style="list-style-type: none">• INGESTION HAZARD: This product contains a button cell or coin battery.• DEATH or serious injury can occur if ingested.• A swallowed button cell or coin battery can cause Internal Chemical Burns in as little as 2 hours.• KEEP new and used batteries OUT OF REACH of CHILDREN.• Seek immediate medical attention if a battery is suspected to be swallowed or inserted inside any part of the body.	

1. Remove and immediately recycle or dispose of used batteries according to local regulations and keep away from children. Do NOT dispose of batteries in household trash or incinerate.
2. Even used batteries may cause severe injury or death.
3. Call a local poison control center for treatment information.
4. Battery type CR2032 / DL2032.
5. 3V_{DC} battery nominal voltage.
6. Non-rechargeable batteries are not to be recharged.
7. Do not force discharge, recharge, disassemble, heat above 100°C (212°F) or incinerate. Doing so may result in injury due to venting, leakage or explosion resulting in chemical burns.

8. The product contains non-replaceable batteries.

Using this guide

This guide can be downloaded from the HP Support Center.

Introduction

This is a brief introduction to the printer and its documentation for new users.

Use and maintenance

To help you carry out normal printer procedures.

Topics include the following:

- [Connecting the printer on page 15](#)
- [Setting up the printer on page 19](#)
- [Paper handling on page 26](#)
- [Printing on page 38](#)
- [Mobile printing on page 45](#)
- [Practical printing examples on page 75](#)
- [Handling ink cartridges and printhead on page 85](#)
- [Maintaining the printer on page 88](#)

Troubleshooting

To help you solve problems that may occur while printing.

Included are the following topics:

- [Troubleshooting paper issues on page 104](#)
- [Troubleshooting print-quality issues on page 121](#)
- [Troubleshooting ink cartridge and printhead issues on page 157](#)
- [Troubleshooting data communication issues on page 158](#)
- [Troubleshooting general printer issues on page 165](#)
- [Text messages and numerical error codes on page 168](#)

Accessories, support and specifications

Reference information, including customer care, the printer specifications, and part numbers for paper types, ink supplies, and accessories.

[Accessories on page 100](#), [HP Customer Care on page 173](#), and [Printer specifications on page 176](#).

Glossary

The glossary contains definitions of printing and HP terms used in this documentation.

[Glossary on page 180.](#)



Index

In addition to the table of contents, there is an alphabetical index to help you to find topics quickly.

Warnings and cautions

Symbols are used in this manual to ensure the proper use of the printer and to prevent the printer from being damaged.

Follow the instructions marked with these symbols:

-  **WARNING!** Failure to follow the guidelines marked with this symbol could result in serious personal injury or death.
-  **CAUTION:** Failure to follow the guidelines marked with this symbol could result in minor personal injury or damage to the printer.

Printer models

The user guide covers the following printer models.

Table 1-1 Printer models

Full name
HP DesignJet T850 36-in Printer
HP DesignJet T850 36-in MFP
HP DesignJet T950 36-in Printer & HP DesignJet XT950 36-in Printer
HP DesignJet T950 36-in MFP & HP DesignJet XT950 36-in MFP

-  **NOTE:** The images appearing in this user guide may not look the same as the printer you have. In some regions, exact naming may vary.

Main features

HP DesignJet T850 Printer Series and HP DesignJet T950 Printer Series are four color inkjet printers, designed to deliver CAD / Construction drawings as well as high quality graphics.

Paper up to 914 mm (36 in) wide can be used to print on. Some major features of the printer are shown below:

- Print resolution of up to 2400 × 1200 dpi using the **Best** print-quality option, the **Maximum Detail** option and photo paper
- The printer can be controlled from its control panel, from a remote computer using the Embedded Web Server.

- Handles roll and cut-sheet paper, with a tray which automatically switches between both
- Touch-sensitive control panel in color, with an intuitive graphical user interface
- Includes Web-connected features such as automatic firmware upgrades
- Supports remote printing from mobile devices with HP App, see the HP website at the following link:
 - You can obtain the latest iOS version from the Apple iTunes website at: <https://itunes.apple.com/app/id469284907>
 - You can obtain the latest Android version from the Google Store website at: <https://play.google.com/store/apps/details?id=com.hp.printercontrol>
- Economode for printing economically
- Enables easy printing from desktop with HP Click, see the HP website at the following link: <https://www.hp.com/go/clickDesignJet>
- Ink and paper usage information available from the Embedded Web Server, see [Access the Embedded Web Server on page 19](#)
- Access to the online HP Support Center, see [HP Support Center on page 173](#)

Main components

Hardware features of your printer.

Front view (HP DesignJet T850 Printer Series)

Overview of the front of the printer's main hardware components.

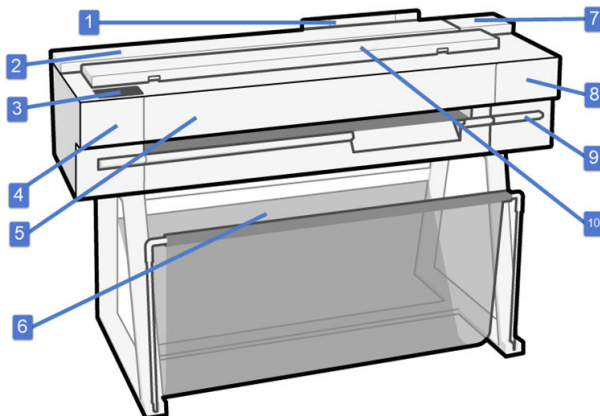

1. Tray
2. Roll
3. Control panel
4. Cutter
5. Main door

6. Stand and bin
7. Ink cartridges
8. Printhead access door
9. Printhead carriage
10. Scanner (only MFP models)

Front view (HP DesignJet T950 Printer Series)

Overview of the front of the printer's main hardware components.

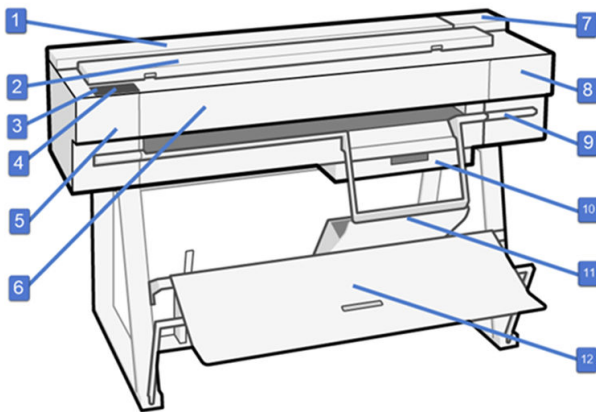

1. Roll
2. Scanner (only MFP models)
3. Hi-speed 2.0 USB host port (only MFP models)
4. Control panel
5. Cutter
6. Main door
7. Ink cartridges
8. Printhead
9. Printhead carriage
10. Cut sheet tray
11. Sheet organizer
12. Large format stacker

Rear view (HP DesignJet T850/T950 Printer Series)

Overview of rear of the printer's main hardware components.

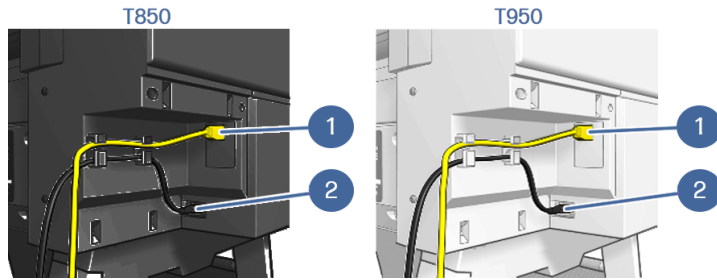

1. Gigabit Ethernet port, to connect to a network
2. Power cable

Installing the HP DesignJet T850/T850 MFP printer

This section explains how to install the HP DesignJet T850/T850 MFP 36-in printers.

Please watch this how-to video on installing the printer:
<http://www.hp.com/go/DesignJetT850/installation-video>.

Alternatively, you can scan the QR code to watch the video.



Installing the HP DesignJet T950/T950 MFP printer

This section explains how to install the HP DesignJet T950/T950 MFP 36-in printers.

Please watch this how-to video on installing the printer:
<http://www.hp.com/go/DesignJetT950/installation-video>.

Alternatively, you can scan the QR code to watch the video.



Turn the printer on and off

The power key is located next to the control panel.

The power key is illuminated when the printer is on, or in sleep mode.

However, if you plan to store the printer for a long period or the power key does not seem to work, you are recommended to unplug the power cord.

To turn it back on, plug in the power cord.

When the printer is powered back on, it takes about three minutes to initialize and check and prepare the printhead.

 **NOTE:** When the printer has not been used for a certain period of time (the default time is determined by Energy Star), it saves power by going into sleep mode. However, any interaction with the printer's control-panel display, or sending a new job to print, returns it to active mode, and it can resume printing immediately. To change the sleep mode time, see [Set the Sleep Mode setting on page 20](#).

Control panel

The control panel is a touch-sensitive screen with a graphical user interface located on the front left of the printer.

The control panel gives you complete control of your printer. From it you can print, view information about the printer, change printer settings, perform calibrations and tests etc. It also displays alerts (warning and error messages) when necessary. The following sections with diagrams and lists provide a quick reference to the main features. Choose your printer model from the following: [HP DesignJet T850 on page 9](#), [HP DesignJet T950 on page 10](#), or [HP DesignJet T850/T950 MFP on page 11](#).

HP DesignJet T850

The control panel lets you access printer functionalities, check status, monitor and manage current and scheduled printer tasks.

2.7 inch control panel

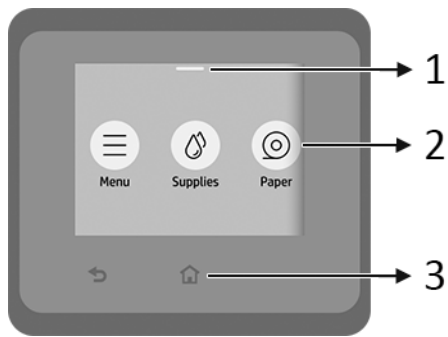

1. **Status center:** Swipe down at the top of the screen to open.
2. **Home screen icons:**
 - **Menu icon** ☰
 - **Supplies icon** 💧
 - **Paper icon** 🎯
 - **Jobs icon** 📄
3. **Others:**
 - **Go back icon** ↶
 - **Home icon** 🏠



HP DesignJet T950

The control panel lets you access printer functionalities, check status, monitor and manage current and scheduled printer tasks.

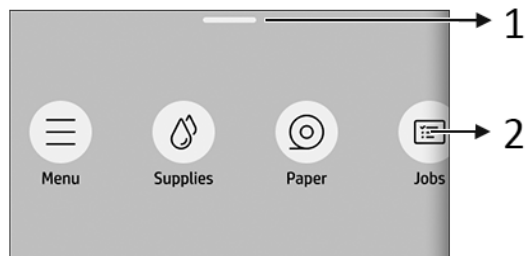
4.3 inch control panel



1. **Status center:** Swipe down at the top of the screen to open.
2. **Home screen icons:**
 - **Menu icon** ☰





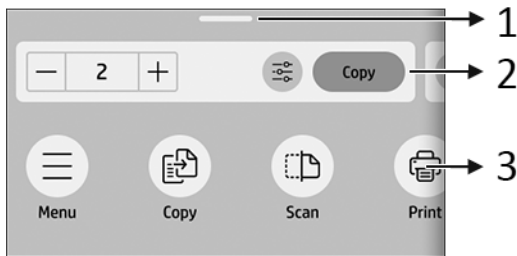

- **Supplies icon** 
- **Paper icon** 
- **Jobs icon** 

HP DesignJet T850/T950 MFP

The control panel lets you access printer functionalities, check status, monitor and manage current and scheduled printer tasks.

4.3 inch control panel



1. **Status center:** Swipe down at the top of the screen to open.
2. **Home widgets:**
 - **Copy**
 - **Scan**
3. **Home screen icons:**
 - **Menu icon** 
 - **Copy icon** 
 - **Scan icon** 
 - **Print icon** 
 - **Jobs icon** 
 - **Supplies icon** 
 - **Paper icon** 

Printer solutions

Drivers and other tools are provided with your printer to raster, review, print locally/remotely, and access support if required.

The following software is available for your printer at the HP website at the following link (depending on printer model):

- **HP DesignJet T850:** <https://www.hp.com/go/DesignJetT850/software>
- **HP DesignJet T850MFP:** <https://www.hp.com/go/DesignJetT850MFP/software>
- **HP DesignJet T950 and HP DesignJet XT950:** <https://www.hp.com/go/DesignJetT950/software>
- **HP DesignJet T950MFP and HP DesignJet XT950MFP:** <https://www.hp.com/go/DesignJetT950MFP/software>

Software content

- HP Click application for Windows 10 or newer and Mac OS, which provide access to easy printing with real preview



Drivers:

1. Windows V4 PCL3 driver.
 2. Mac print driver.
- HP app for Windows, Android, MacOS, and iOS, which offers mobile printing and monitoring features
 - The Embedded Web Server that allows you to manage the printer from a remote computer, update the printer's firmware and change various printer settings, etc.

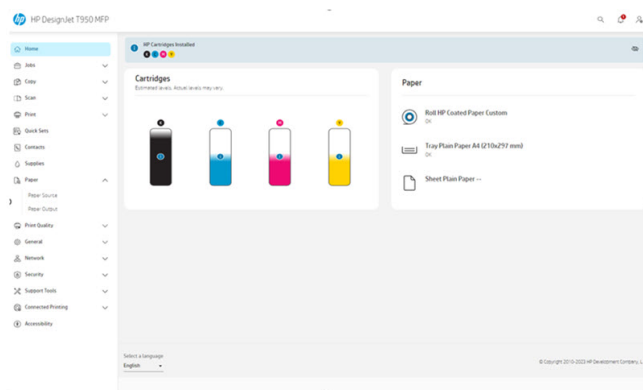

See [Access the Embedded Web Server on page 19](#).



NOTE: New versions of all printer software can be expected to appear from time to time. In some cases, when you receive your printer there may already be later versions available on HP's website of some of the software provided with it.

Mobile printing

With HP Mobile Printing Solutions, you can print straight from your phone or tablet in just a few simple steps wherever you are using your mobile device OS.

- HP app enhances your printing capabilities and enables scanning and sharing from your phone or tablet.
 - You can obtain the latest iOS version from the Apple iTunes website at: <https://itunes.apple.com/app/id469284907>
 - You can obtain the latest Android version from the Google Store website at: <https://play.google.com/store/apps/details?id=com.hp.printercontrol>
- Apple iOS printing is enabled through AirPrint, which comes pre-installed in iOS devices
- For ChromeOS printing
 - You can use the Chrome Native Print system, which comes pre-installed in ChromeOS devices.
- For Android printing
 - Install the HP Print Service app. If you have already installed it, check that it is up to date. You can obtain the latest version from the Google Play website at: <https://play.google.com/store/apps/details?id=com.hp.android.printservice>
 - Alternatively, you can install Mopria Print Service Plugin. You can obtain the latest version from the Google Play website at: <https://play.google.com/store/apps/details?id=org.mopria.printplugin>
 - You can also print using the Android Default Print Service, which comes preinstalled in Android devices



For more information, visit the HP website at: <http://www.hp.com/go/designjetmobility>.

Reports

The internal prints give various kinds of information about your printer. They can be requested from the control panel.

Before requesting any internal print, check that the printer and the paper are ready for printing. The loaded paper should be at least A4 portrait–210 mm (8.27 in) wide—otherwise the print may be clipped.

 **NOTE:** For U.S. and other countries that don't use ISO sizes; Letter is the required paper size for reports. Reports are generated in A4 or letter depending on the selected country.

To print any internal print, tap the **Menu** icon , then **Tools**  > **Reports** , then select the internal print you want. These are some of the prints available:

- Usage Report
 - This report is not printable and can only be viewed on the control panel
- Status Reports
 - Connectivity, Printer Status Report, etc.

- Demo Pages
- Event Log



 **NOTE:** Reports can also be printed from the Embedded Web Server or downloaded as a PDF; go to **Support Tools > Reports and Pages.**

2 Connecting the printer

Printing has never been easier, and your printer comes with various options for connecting to help you do so.

With HP Smart Admin (see the HP website at the following link: <https://admin.hpsmart.com/>) or HP Command Center (see the HP website at the following link: <https://hp-commandcenter.com/>), you have a remote view to manage printers, users, and solutions, which allows you to stay on top of your team to keep your company up and running smoothly.

Choose which connection method to use

Your printer can be connected via Wireless or Gigabit Ethernet.

Connectivity methods

Step 1: Connect the printer to your network

Use the control panel to choose one of these options:

- Connect to Ethernet:
 - If printer is new, connect the Ethernet cable before turning it on
- Connect to Wi-Fi:
 - If the printer is new, just follow the steps in the control panel
 - Printer and device (e.g., desktop, PC, laptop, mobile) must be connected to the same Wi-Fi

Step 2: Set up your device

a) Connect the printer to the HP ecosystem

During the printer setup, after performing the network configuration and accepting that printer will connect to the internet, the printer retrieves the pin pairing code and displays it along with the portal URL. Follow the instructions on the control panel.

In case the printer onboarding is skipped, you can pair your printer manually; access the embedded web server (EWS), then go to **Connected Printing > Printer Pairing**.



NOTE: You may be asked to type the administration password.

1. Tap **Start Pairing** to begin pin pairing.

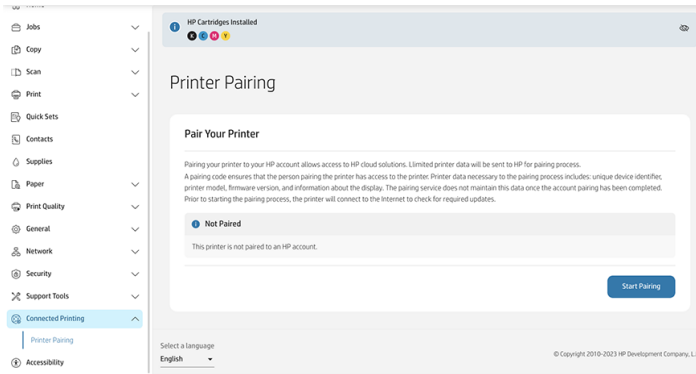

You can see the progress in the window that appears:

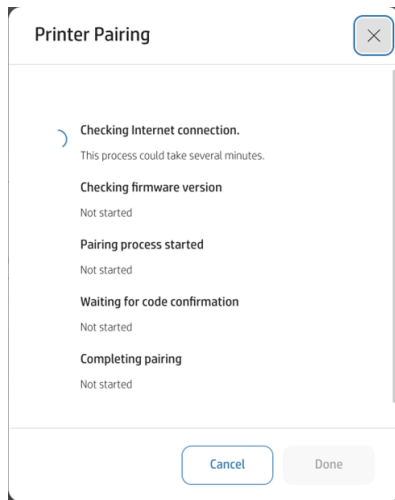

2. The process asks you to check the control panel to retrieve and enter the pairing code. It also indicates which URL you should type in the browser to continue the onboarding process.

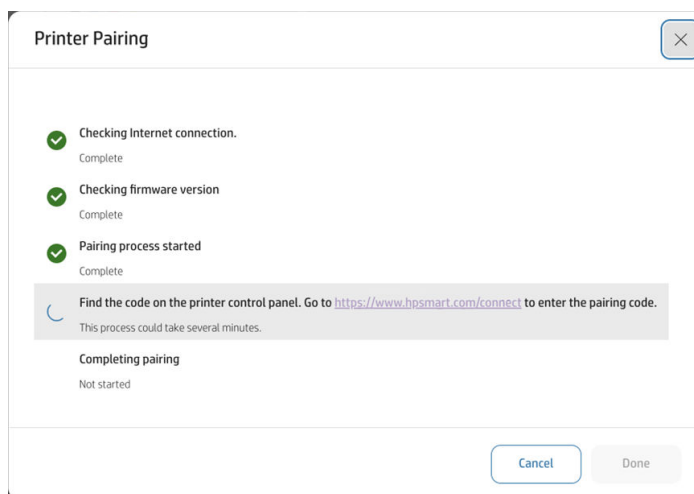

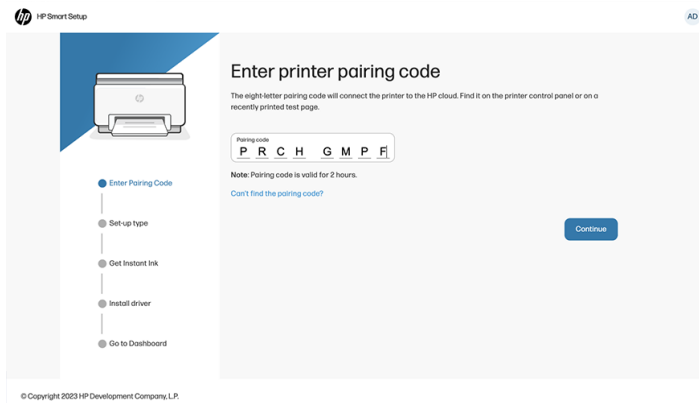

3. Once the process has completed and the printer is paired, the following message is displayed:

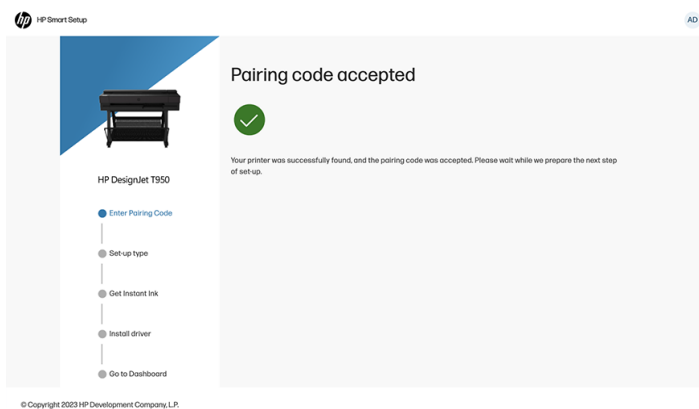

Printer and devices must be connected to the same network.

If required you can find your printer's IP by scrolling down from the top of the screen.

- – Go to the support page for your printer series on the HP website at the following link (depending on printer model):
 - **HP DesignJet T850:** <https://www.hp.com/go/DesignJetT850/support>
 - **HP DesignJet T850MFP:** <https://www.hp.com/go/DesignJetT850MFP/support>
 - **HP DesignJet T950 and HP DesignJet XT950:** <https://www.hp.com/go/DesignJetT950/support>
 - **HP DesignJet T950MFP and HP DesignJet XT950MFP:** <https://www.hp.com/go/DesignJetT950MFP/support>

 **NOTE:** If you connect an Ethernet cable, it turns off the wireless capability of the printer.



 **NOTE:** Wireless connections can be affected by the location of the network router and the device. In order to improve a wireless connection:

1. Position the wireless access point in a more central position within the work place.
2. Place the wireless access point away from dense materials. Metal, concrete, double thick walls are the hardest to penetrate, wood and plasterboard are easier. Consider this when you position the printer.

3. Change the wireless channel to one that is not being used. Preferably 1, 6, or 11, as these are non-overlapping channels.
 4. Extend the range of the wireless network with the use of a simple wireless extender or add more wireless access points.
-

Connect the printer to your network

On the control panel, use the **Wireless Setup Wizard** or **Wi-Fi Protected Setup** to set up wireless communication.

1. Tap the **Menu** icon , then **Settings**  > **Network** > **Wi-Fi**.
2. Tap **Wireless Setup Wizard** or **Wi-Fi Protected Setup**.
3. Follow the control panel instructions to complete the setup.

If you are already using the printer with a different type of connection, to change it, see [Mobile printing on page 45](#).

Set up your device

Prepare your printer with the correct software for your device.

Install the software (Windows)

Make sure to connect the printer and computer or mobile device to the same network.

To download the software, see [Printer solutions on page 11](#).

Install the software (Mac OS X)





Make sure to connect the printer and computer or mobile device to the same network.

To download the software, see [Printer solutions on page 11](#).

Add your printer

Add a printer to a network under Mac OS X.

- Go to **System Preferences** > **Printers and Scanners**, and then tap + to add a new printer.
 - **If you installed the driver:** Select the **IP** tab, enter your IP address, and select the protocol **HP Jetdirect-Socket**. Tap **Continue**.
 - **If you want to use AirPrint:** Choose your printer from the list of displayed network printers, and tap **Add**. Then, in the **Use** menu, select **Secure AirPrint** or **AirPrint**, and then tap **Add**.

 **TIP:** To see the bonjour name on the control panel, open the printer's dashboard and tap the **Menu** icon , then **Settings**  > **Network** > **Ethernet** > **Ethernet Details**, or **Settings**  > **Network** > **WiFi** > **Wi-Fi Details**.

3 Setting up the printer

Introduction

There are various printer settings that the printer administrator may wish to control as soon as a new printer is assembled and ready for use.

Accessibility

To ensure accessibility to the operating area, it is recommended to have an even-leveled clear space of minimum 760 mm (30 inches) by 1220 mm (48 inches).

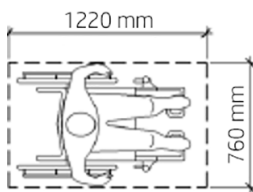



Light reflection (glare) can affect the readability of the control panel. To improve visibility, from the control panel, select the most suitable theme.

Change the language of the control-panel display

Your printer includes many language options to choose from.

To change the language of the control-panel menus and messages:

If you can understand the current control-panel display language, tap the **Menu** icon , then **Settings** , then **General** > **Display** > **Language**. Select your preferred language.



Access the Embedded Web Server

Manage your printer remotely using an ordinary web browser running on any computer.

To access the Embedded Web Server on any computer, open your Web browser and type the IP address of your printer.

You can see your printer's IP address on the control panel when you open the **Status Center**.

To access the Embedded Web Server, the printer requests your Admin PIN to prevent unauthorized users from remotely configuring the printer, or viewing printer settings. The PIN is required to change or view printer settings. By default the user is **admin**. The PIN is found behind the printer.

You can print the printer status report, go to **Menu**  > **Tools**  > **Reports**  > **Status Reports**, then tap **Print**.

 **NOTE:** The status report has the PIN. If you changed the initial PIN by default and forgot it, go to [Troubleshooting general printer issues on page 165](#).

The following browsers are known to be compatible with the Embedded Web Server:

- Microsoft Edge (latest version)
- Apple Safari 15 or later for OS X 10.15 and later
- Mozilla Firefox (latest version)
- Google Chrome (latest version)

If you have followed these instructions but failed to get through to the Embedded Web Server, see [Cannot access the Embedded Web Server on page 166](#).

Change the language of the Embedded Web Server

The default language is the same as your browser but if it is not supported, it will appear in English. You can change it to any supported one.

Embedded Web Server supported languages are English, Portuguese, Catalan, Spanish, French, Italian, German, Polish, Russian, Simplified Chinese, Traditional Chinese, Korean, and Japanese. There is a tab at the bottom left of the window to select them from.

Automatic firmware update

The printer can automatically check for a firmware update periodically.

Set Windows driver preferences

You can change some default settings in your printer driver according to your own preferences, for instance to set color or paper-saving options.

To change default settings, click the **Start** or **Search** button on your computer's screen (depending on your version of Windows), then click **Devices and Settings**, **Devices and printers** or **Print Management**. Then right-click your printer's icon and click **Printing preferences** or **Set Printing Defaults**. Any settings you change in the Printing Preferences window will be saved as default values for the current user.



To set the default values for all the users of your system, right-click the printer's icon again, click **Printer Properties**, go to the Advanced tab, and click **Printing Defaults**. Any settings you change in the Printing Defaults window will be saved for all users.



Energy-conservation settings

Learn about the energy-conservation settings that are available on your printer.

Set the Sleep Mode setting

Use the control panel menus to specify the amount of time the printer must be inactive before it goes into sleep mode.





1. From the home screen on the printer control panel, tap the **Menu** icon , then **Settings** .
2. Scroll to and open the following menus: **General** > **Energy** > **Sleep**.

3. Tap an option to specify the amount of time the printer must be inactive before it goes into sleep mode.
4. When you are finished, tap the **Back arrow** button  to return to the **General** menu, or tap the **Home** button  to return to the home screen.

 **NOTE:** You can perform the same operation from the Embedded Web Server by going to **General > Power settings > Energy settings**.

Set the Shutdown Mode setting



Use the control panel menus to specify the amount of time the printer must be inactive before it shuts down.

1. From the home screen on the printer control panel, tap the **Menu** icon , then the **Settings** icon .
2. Scroll to and open the following menus: **General > Energy > Inactivity Shutdown**.
3. Tap an option to specify the amount of time the printer must be inactive before it shuts down.
4. When you are finished, tap the **Back arrow** button  to return to the **General** menu, or tap the **Home** button  to return to the home screen.

 **NOTE:** You can perform the same operation from the Embedded Web Server by going to **General > Power settings > Energy settings**.

Set scheduled on/off time

Use the control panel menus to specify when to automatically turn the printer on and off.

1. From the home screen on the printer control panel, tap the **Menu** icon , then **Settings** .
2. Scroll to and open the following menus: **General > Energy > Scheduled Printer On/Off**.

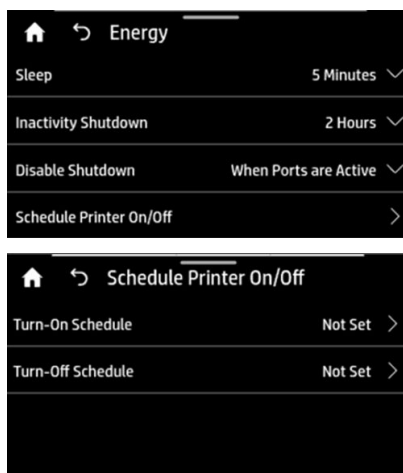

3. Tap an option to specify set the scheduled on or off time (on shown).

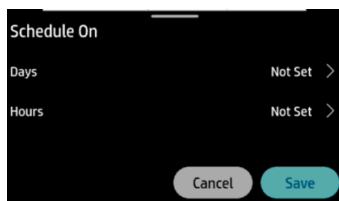

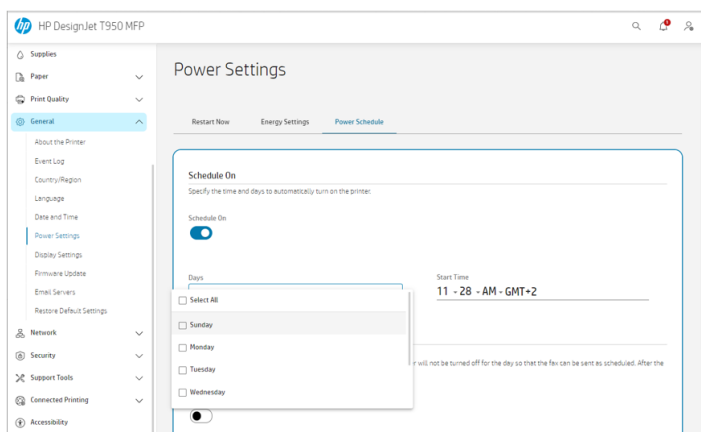
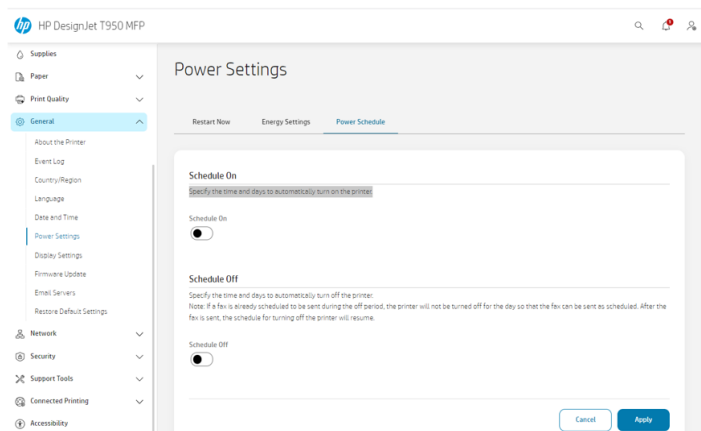

4. Set the day(s) and time.

 **NOTE:** You can perform the same operation from the Embedded Web Server by going to **General > Power settings > Power schedule**.





Change the control-panel display brightness

The level of brightness displayed can be adjusted.

To change the brightness of the control panel, tap the **Menu** icon , then **Settings** , then **General > Display > Display Brightness** and slide to your desired level.

Configure network settings

You can view and configure the network settings from the Embedded Web Server or the control panel.

- From the Embedded Web Server: Select the **Network** tab.
- From the control panel, tap the **Menu** icon , then **Info** , then **Connectivity**.
- From the control panel, tap **Settings** , then **Network**.

The following options are available:

- **Enable/Disable wireless** turns the wireless connection on or off.
- **Wireless setup wizard** provides an easy way to connect to a wireless network.
- **Wi-Fi protected setup** allows you to set up a connection with a wireless network using WPS (pushbutton or pin) encryption.
- **View wireless details** displays information about the wireless network.
- **IP settings** allows you to select the IP address -automatic or manual (Static).
- **Print Wireless test report** print information about the wireless network.
- **Print wireless network test** runs diagnostic tests of wireless connectivity.
- **Ethernet settings** view and print Ethernet details:
 - **Link speed** sets the speed at which data are transmitted over the network. The default is **Automatic**.
 - **IP settings** allows you to view or change the IP address, subnet mask, default gateway, and DNS address.
 - **Network settings**.
 - **Hostname** allows you to change the hostname.
 - **Proxy settings** allows you to change the proxy settings.
 - **Bonjour name** allows you to change the bonjour name.
- **Restore Network Settings**.

Configure firewall settings

Firewall features provide network-layer security on both IPv4 and IPv6 networks. The firewall provides simple control of IP addresses that are allowed access.

 **NOTE:** In addition to firewall protection at the network layer, the printer also supports open secure sockets layer (SSL) standards at the transport layer for secure client-server applications, such as client-server authentication or HTTPS Web browsing.

For firewall operation on the printer, go to **Menu**  > **Settings**  > **Network** > **Security** > **Disable**

Firewall: You must configure a firewall policy to apply to specified IP traffic. Firewall policy pages are accessed through the Embedded Web Server and displayed by your Web browser. After a policy is configured, it is not activated until you click **Apply** in the Embedded Web Server.

Creating and using firewall rules

Control IP traffic and allow or drop IP traffic based on IP addresses and services.

Enter up to ten rules, each rule specifying the host addresses, services, and the action to take for those addresses and services.

Create a firewall rule

Set up a new rule from the Embedded Web Server.

1. Open the Embedded Web Server.
2. Tap the **Network** tab, then **Network Security > Firewall**.
3. Select **Enable Firewall**.
4. Tap the **Add** icon , and then follow the onscreen instructions.



NOTE: After you tap **Apply**, the connection to the Embedded Web Server might be temporarily disrupted for a short period of time. If the IP address was unchanged, the Embedded Web Server connection will be enabled again. However, if the IP address was changed, use the new IP address to open the Embedded Web Server.

Change the priority of firewall rules

You can move a rule up or down to select the priority from the **Rule Precedence** list.

1. Open the Embedded Web Server.
2. Tap the **Network** tab, then **Network Security > Firewall**.
3. Select the priority by selecting a rule and moving up and down using the arrows.
4. Tap **Apply**.

Change firewall options

Options can always be edited at a later date.

1. Open the Embedded Web Server.
2. Tap the **Network** tab, then **Network Security > Firewall**.
3. Change whatever options you wish, then tap **Apply**.



NOTE: After you tap **Apply**, the connection to the Embedded Web Server might be temporarily disrupted for a short period of time. If the IP address was unchanged, the Embedded Web Server connection will be enabled again. However, if the IP address was changed, use the new IP address to open the Embedded Web Server.

Reset firewall settings

Restore the printer's network settings to reset to factory defaults.

Limitations to rules, templates, and services



There is a limit per item that can be created and stored at any one time.



Table 3-1 Limitations per item

Item	Limit
Maximum number of rules	10 (one default rule)
Maximum number of address templates	12
Maximum number of user-defined address templates	5
Maximum number of services you can add to a user-defined service template	40
NOTE: The predefined All Services template is not subject to this limitation and includes all services supported by the print server.	
Maximum number of services you can add to the policy	40
NOTE: For a given rule, only one address template and one service template can be added.	
Maximum number of service templates in the policy	10
Maximum number of user-defined custom service templates	5

Reset network settings

The network settings can be reset or restored to default.

Go to the control panel and tap the **Menu** icon , then **Settings** , then **Network**, then **Restore network settings**.

Alternatively, tap the **Menu** icon , then **Tools**  > **Maintenance**  > **Restore settings** > **Restore network settings**.

 **NOTE:** Print the network configuration page and check that the network settings have been reset.

 **NOTE:** Resetting the printer's network settings also resets the printer's firewall settings.

4 Paper handling

To print you can load rolls, single sheets, or use the tray.

General paper-loading advice

You can load paper into the printer in three different ways: from a roll, as a single sheet, or as a stack of single sheets from the tray. Switching from one to another is automatic.

- ⚠ **CAUTION:** If your model has a stand, make sure the printer wheels are locked (the brake lever is pressed down) to prevent the printer from moving the automatic switch between the roll and tray.
- ⚠ **CAUTION:** All roll paper must be 368.3 mm (14.5 in) or wider. A4 and letter paper should not be loaded in landscape orientation in the tray.
- 💡 **TIP:** For photo paper wear cotton gloves to avoid transferring oils onto the paper.
- ⚠ **CAUTION:** Keep the bin closed throughout the loading process.

Load a roll onto the spindle

Rolls of different widths can be loaded onto the printer.

1. From the control panel, tap the **Paper** icon , then select the roll, then tap the **Load** button.

 **NOTE:** This step is optional: when you start to feed roll paper into the printer, it automatically recognizes if you are loading a roll or a single sheet.

2. Remove the spindle from the printer.

⚠ **WARNING!** Do not insert your fingers into the spindle supports during the removal process.

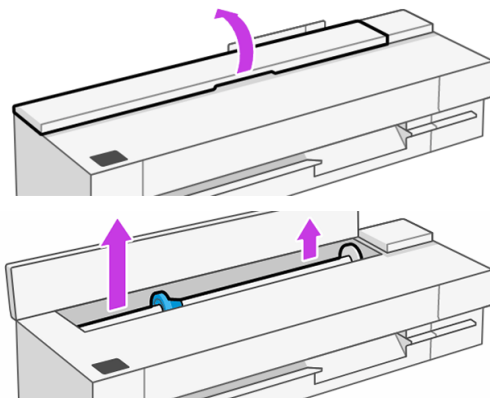

- The spindle has a stop at each end to keep the roll in position. The blue stop can be removed to mount a new roll; it slides along the spindle to hold rolls of different widths. Remove the blue paper stop from the end of the spindle.

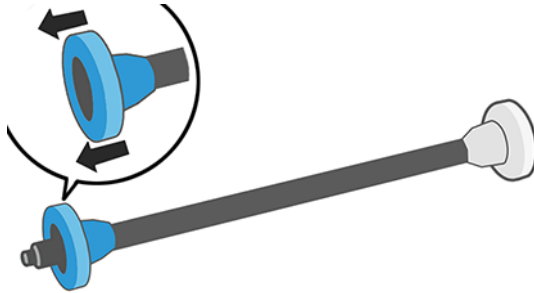

- If the roll is long, rest the spindle horizontally on a table and load the roll on the table.
- Slide the new roll onto the spindle. Make sure the paper type is oriented as shown. If it is not, remove the roll, turn it 180 degrees and slide it back on to the spindle. There are labels on the spindle showing the correct orientation.



- Looking from the front of the printer, put the blue paper stop on to the open end (left side) of the spindle, and push into the end of the roll.

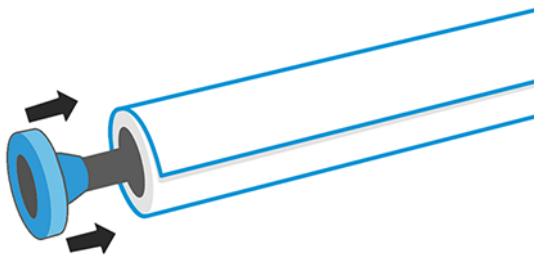

- Ensure the blue paper stop is pushed in as far as it goes.



NOTE: Check that there is no space between the roll and the stops at both ends.

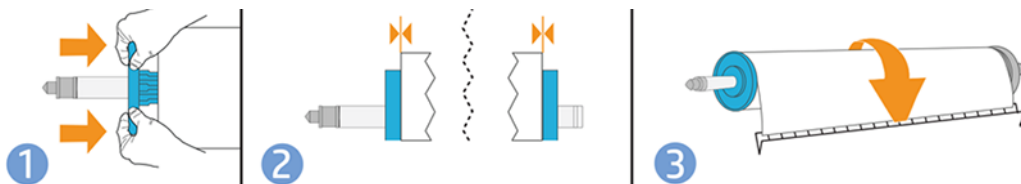

TIP: If you are a regular user of different paper types, you can change rolls more quickly if you preload rolls of different paper types on different spindles. Extra spindles are available for purchase, see [Accessories on page 100](#).

Load a roll into the printer

Before you start this procedure, you must have a roll loaded on the spindle.

See [Load a roll onto the spindle on page 26](#).

1. Insert the spindle into the printer, holding it by both ends. The blue hub should be on the left, as viewed from the control of the printer.

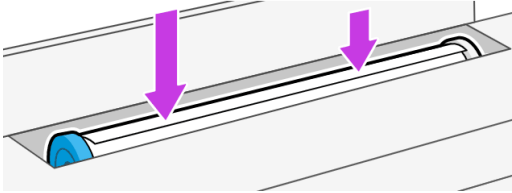

2. If the edge of the roll is not straight or torn (sometimes due to tape used to hold end of the roll), pull the paper slightly and cut a straight edge.
3. Insert the edge of the paper into the printer.

⚠ WARNING! Do not push your fingers inside the printer's paper path.

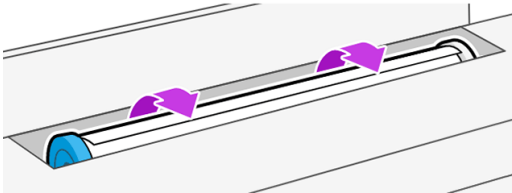

4. Roll the paper into the printer until you feel resistance and the paper flexes slightly. When the printer detects the paper, it beeps, and feeds in the paper automatically.
5. The control panel prompts you to select the paper category and type. To select the paper type, click on the type and the different paper categories are shown

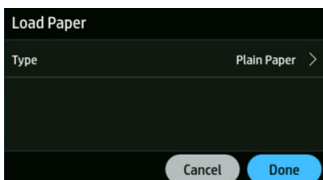

Plain paper was the last to be loaded.



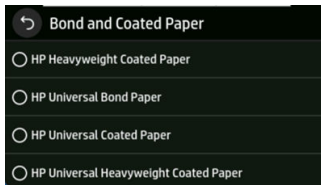

If you do not see your paper type in the control panel, tap **More paper types**. If you still cannot find your paper type in the whole list, see [Paper type is not in the driver or control panel on page 106](#).

6. The printer checks the alignment and measures the width. If the roll is not correctly aligned, follow the instructions on the control-panel display.

 **NOTE:** If you have an unexpected issue at any stage of the paper loading process, see [Paper cannot be loaded successfully on page 104](#).

Unload a roll

If there is paper on the roll, you can unload it from the control panel.

1. From the control panel, tap the **Paper** icon , then select the roll, then tap the **Unload** button, then **Unload roll**. Afterwards, the tray will become the default active paper source.
2. If the end of the paper is no longer attached to the core, the control panel asks you to unload the roll manually.

 **NOTE:** If you don't load a new roll, or if a roll is unloaded; the tray is the default active paper source.

Use the tray (HP DesignJet T850)

Load multiple sheets and ease single sheet printing.

1. If no roll is loaded or the roll has run out of paper, the tray is active by default.

Alternatively, from the control panel, tap the **Paper** icon  , then select the **Tray**.

2. Adjust the input tray extensions depending on the length of the paper: the first extension for A4 and the second extension for A3 paper.

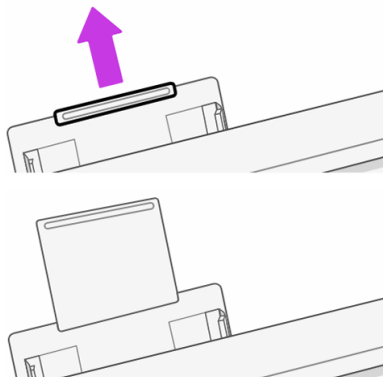

3. Load sheets of paper into the tray with the printed side facing outwards. Ensure that the sheets are all of the same size.



4. Adjust the tray to fit the width of the paper.

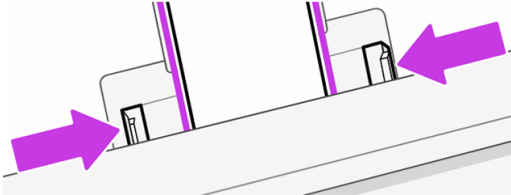

Use the tray (HP DesignJet T950)

Load multiple sheets and ease single sheet printing.

1. Open the tray.

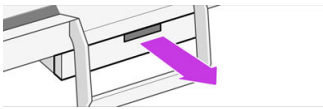

2. Load paper into the tray.

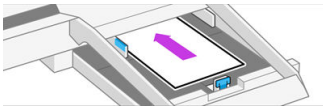

3. Adjust the paper guides.

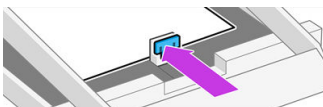

4. Close the tray.

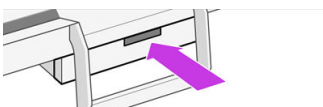

 **NOTE:** Remember to use width adjusters when loading different media width.



When paper is loaded into the multi-sheet tray, or when the drawer is closed, the control panel confirms the paper type and size loaded.

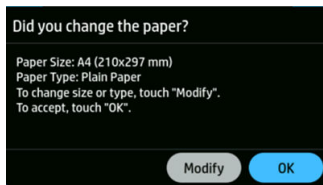

Load a single sheet

Roll paper and single sheets use the same input slot in the printer.

 **NOTE:** If you have a tray see [Use the tray \(HP DesignJet T850\) on page 29](#).

 **NOTE:** Sheets of width 329 mm (12.95 in) or less should be loaded from the tray.

1. From the control panel, tap the **Paper** icon , then select **Sheet**, then tap the **Load** button.
2. If a roll is already loaded, you have to wait while it is automatically unloaded.
3. Open the roll cover.

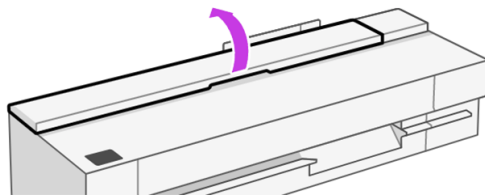

4. Select your paper category and type. If you do not see your paper type in the control panel, tap **More paper types**. If you still cannot find your paper type in the whole list, see [Paper type is not in the driver or control panel on page 106](#).
5. When prompted by the control panel, insert the sheet into the right-hand side of the input slot.

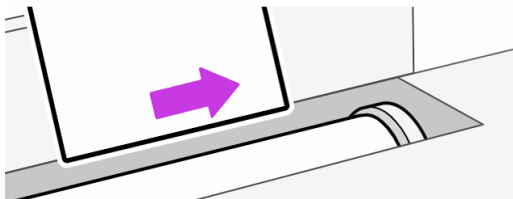

 **WARNING!** Do not push your fingers inside the printer's paper path.

6. Align the sheet with the line.

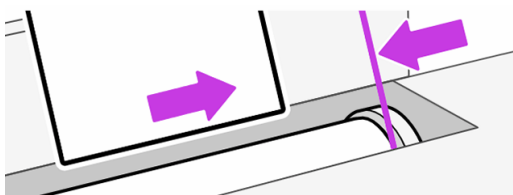

7. Guide the sheet into the printer; this is especially important with thicker papers.

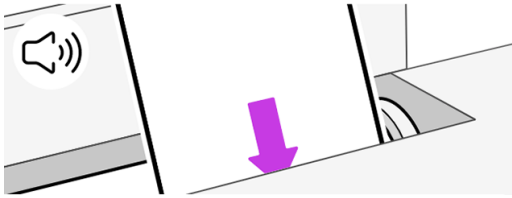

8. The printer checks the alignment and measures the sheet.

 **NOTE:** Depending on the width of the sheet, it feeds out the front of the printer.

9. If the sheet is not correctly aligned, you may be asked to reload it.

 **NOTE:** If you have an unexpected problem at any stage of the paper loading process, see [Paper cannot be loaded successfully on page 104](#).

Unload a single sheet

Sheets are unloaded from the front of the printer.

1. To unload a sheet, go to the control panel and tap the **Paper** icon , then **Sheet loaded > Unload**.
2. Either catch the sheet manually or allow it to fall into the bin.

 **NOTE:** If you don't load a new sheet, the tray is the default active paper source.

Use the stacker (HP DesignJet T950)

The stacker has two primary configurations: A2 (ANSI C) and A1 (ANSI D) (default), or A0 (ANSI E). You can use either configuration to collect printed line drawings, but must ensure that it matches the substrate size.

Up to 40 line drawings can be collected on the stacker. In the A0 (A0/E) configuration, it can hold printed documents up to 1189 mm (46.8 in) long.

- **For A2 (A2/C) and A1 (A1/D) portrait size collection (default):** Install the stacker and sheet organizer as shown for the default configuration. Refer to the assembly instructions for detailed set-up information. Ensure that the backboard is resting flat on the four support adapters.

Figure 4-1 Default configuration

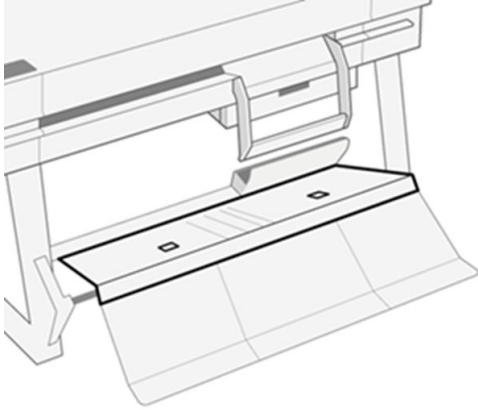

- **For A0/E size portrait size collection:** From the default configuration, standing in front of the printer, pull the backboard forward using the two square finger grooves. The backboard will rotate downwards and reveal a deeper media fabric path for A0 (A0/E) roll size collection.

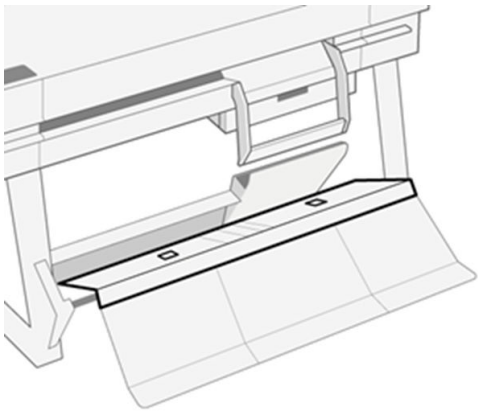
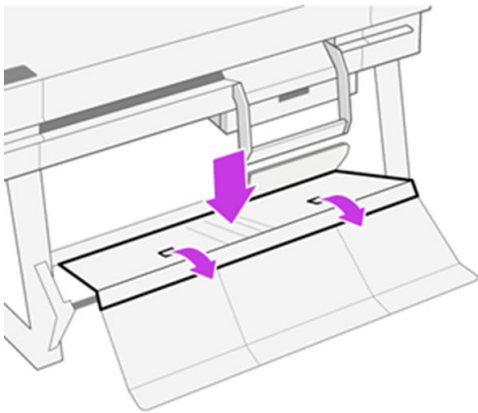

If you want to return to default A2 (ANSI C) and A1 (ANSI D), follow the instructions below:

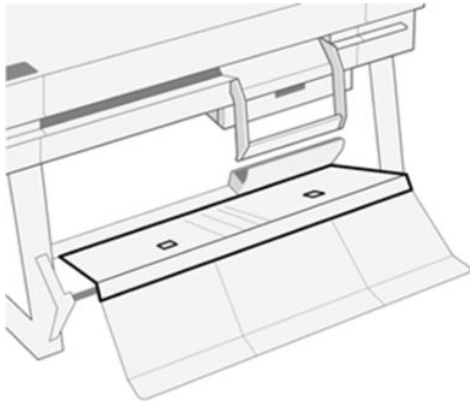
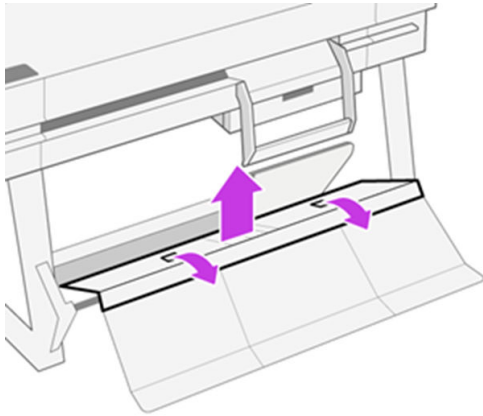

If the output is not stacked properly, you can try changing from default to regular bin style configuration. In this position, the stacker acts as a normal basket. The basket can accept up to 10 A1 or D-sized sheets of bond paper. Larger prints should be removed from the basket immediately after printing. See [Change stacker from default to regular bin style configuration on page 116](#) on how to configure this position.

To get the best results from your stacker:

- Keep the area around the stacker as clean as possible. Avoid having elements that may interfere with the printer's output paper.
- Ensure the stacker is properly maintained, with all components in one of the primary configurations. For any issues, refer to the beginning of this section on the previous page. For example, the stacker's outer board must be extended for it to work properly.
- Use according stacker configuration positions for the page size being printed. A0 (A0/E) is for large sizes, A1/A2 for A1, ANSI D, Arch D.
- Where possible, group pages of the same size. This facilitates the proper operation of the stacker.
- Where possible, print big pages before smaller ones to maximize stacking capacity.
- A temperature and humidity-controlled environment will help stacker performance. Placing your printer in a standard office ambient will get the best results from your stacker.
- The stacker is not intended for plot storage. It is best to pick up plots when they are printed.
- Avoid using very curly rolls. Highly curled plots are difficult to stack properly. Remember that the stacker has a regular bin style configuration that may help in this case.

For any issues, refer to the troubleshooting chapter. See [Troubleshooting paper issues on page 104](#).

Use the sheet organizer (HP DesignJet T950)

The sheet organizer has two configurations for collecting printed cut-sheets: A4 or A3 (ANSI A or ANSI B) (default). You can use either configuration, but must ensure it matches the substrate size to prevent collection issues.

The number of plain documents that can be collected on the sheet organizer is up to 50 sheets and non-plain is up to 10 sheets. In A3 (ANSI B) configuration, the sheet organizer can hold printed documents up to a length of 432 mm (17 in).

- **For A3 and ANSI B size cut-sheet collection:** The length adjuster needs to be in the up position which is parallel to the tray. The length-adjuster lever is found on the right side of the tray.

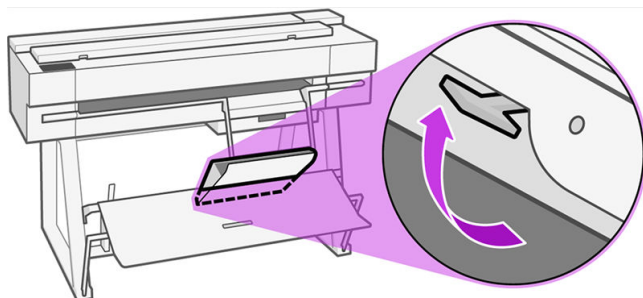

- **For A4 and ANSI A size cut-sheet collection:** The length adjuster needs to be in the down position which is perpendicular to the tray. Rotate the lever counter clockwise until it snaps into the down position.

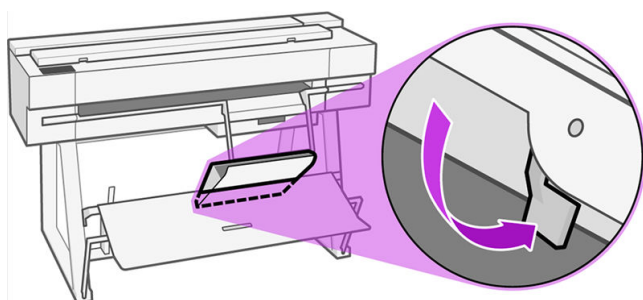

For any issues, refer to the troubleshooting chapter. See [Troubleshooting paper issues on page 104](#).

Sheet organizer configuration	297 mm (11.7 in) ≤ Plot length ≤ 420 mm (16.5 in)	Plot length ≤ 297 mm (11.7 in)
	A3/ANSI B size or longer	A4/ANSI A size or smaller
A3/ANSI B	50 (plain paper) 10 (other paper)	
A4/ANSI A		50 (plain paper) 10 (other paper)

View information about the paper

Tap the icon of the active paper source.

The following information is displayed on the control panel:

- Paper type you have selected
- Roll or sheet status
- Width of the paper

If no tray, roll, or single-sheet paper is loaded, the message **Out of paper** is displayed.

Maintain paper

Always protect your paper and sheets to print at the highest quality.



- Store rolls covered by another piece of paper or cloth
- Store cut sheets covered and clean or brush them before loading them in the printer
- Clean input and output platens
- Always keep the top cover of your printer closed



NOTE: Photo and coated paper requires careful handling, see [Print is scuffed or scratched on page 126](#).

Change the drying time

You may wish to change the drying time setting to suit special printing conditions such as multiple prints where time is of higher importance or when you need to be sure ink is dry before handling.

Tap the **Menu** icon , then **Settings** , then **General > Extra Dry Time**. You can select:

- **Extended**, to set a longer than recommended time to ensure ink is completely dry
- **Optimal**, to set the default and recommended time for your selected paper (this is the default setting)
- **Off**, to disable the drying time and remove your print as soon as it finishes printing





CAUTION: If the ink is not dry when the print is removed it could leave ink in the output tray and marks on the print.



NOTE: If you cancel the drying time during a print, the printer may not feed and cut the paper right away due to the printhead maintenance, which runs in parallel. If the dry time is zero, the printer cuts the paper and then performs the printhead maintenance. However, if the dry time is greater than zero, the printer does not cut the paper until after the printhead maintenance has completed.

Turn the automatic cutter on and off

You can change the cutter option to suit your requirements for each print job.

To turn the printer's paper cutter on or off, go to the control panel and tap the **Menu** icon , then **Settings** , then **Output destination > Horizontal cutter**.

The default setting is **On**.

 **NOTE:** If the cutter is turned off, it will not cut the paper between jobs, but it will continue to cut the paper on loading and unloading rolls.

 **TIP:** To cut roll paper while the automatic cutter is disabled, see [Advance button and cut button on page 37](#).

Advance button and cut button

You can advance the paper with, or without cutting it.

From the control panel, tap **Paper**  > **Roll**, then tap the **Advance and Cut** icon 

The **Advance** option advances the paper without cutting it. **Cut** advances the paper and makes a straight cut across the front edge. There are at least two possible reasons why you might want to do this:

- To trim the leading edge of the paper if it is damaged or not straight.
- To advance and cut the paper when the automatic cutter has been disabled.

 **CAUTION:** Remove the cut piece from the output platen. If strips or short prints are left on the output platen, the printer could jam. Check also that there are no pieces of paper in the cutter guide.

 **NOTE:** Photo and coated paper requires careful handling, see [Print is scuffed or scratched on page 126](#).

5 Printing

Printing has never been easier or more flexible. Print from computers and mobile devices with the use of a variety software, customizable options and advanced settings.

Easy printing with HP Click

HP Click is an easy-to-use software tool designed for people who want a simple way of printing on large format printers.

It provides several benefits to simplify the print experience, such as nesting, batch printing and real print preview. In combination with the cut sheet tray, you can send to print multi-sized documents all at once.

Ideal for a broad range of graphics and technical applications, including posters, roll-up banners, info-graphic presentations, maps, and CAD documents. See the HP website at the following link: <http://www.hp.com/go/clickDesignJet>.

Printing from an application using a printer driver

This is the traditional way of printing from an application.

The correct printer driver must be installed on the computer, and the computer must be connected to the printer by network.

When the printer driver has been installed and the computer is connected to the printer, you can print from a software application by using the application's own **Print** command and selecting the correct printer.

Advanced print settings

Advanced print settings can be used when the defaults do not meet your requirements.

The rest of this chapter explains the various print settings that you can use. These methods offer a relatively large number of settings in order to satisfy all requirements.

 **TIP:** In general you are recommended to use the default settings unless you know that they do not meet your requirements.

 **TIP:** If you intend to reuse a particular group of settings repeatedly, you can save those settings under a name of your own choice and recall them later. A saved group of settings is known as a 'quick set' in the Windows printer driver.

Select print quality

The printer has various print-quality options because best-quality printing requires some loss of speed, while fast printing implies some reduction in print quality.

You can select the options: **Best**, **Normal** and **Fast**. If you select **Fast**, you can also select **Economode**, which consumes less ink, increases printing speed even further, but reduces print quality. **Economode** can only be selected from the advanced options.

There are supplementary custom options that may have an effect on print quality: **Maximum detail**. See [High-quality printing on page 42](#).

You can select print-quality options in the following ways:

- **In the Windows drivers dialog:** Go to **Basic>Print quality**.
- **In the Mac OS X Print dialog:** go to the **Paper/Quality** panel and look at the **Quality Options** section. If you select **Standard** quality options, you will see a simple slider with which you can select speed or quality. If you select **Custom** quality options, you will see the more specific options described above.

 **NOTE:** If the print quality is set from your computer, it overrides the print-quality setting in the control panel.

 **NOTE:** You cannot change the print quality of pages that the printer is already receiving or has already received (even if they have not started to print yet).

Select paper size

The paper size can be specified and the document can be rescaled if necessary.

 **NOTE:** The paper size specified should be the paper size the document was created at. It is possible to rescale the document to a different size for printing. See [Rescale a print on page 41](#).

- **In the Windows driver dialog:** Go to **Basic > Document size** and select the paper size from the list.
- **In the Mac OS X Print dialog:** Select your printer from the **Printer** list, then select your paper size from the **Paper Size** list.

 **NOTE:** If your application offers no **Page Setup** dialog, use the **Print** dialog.

 **NOTE:** If the paper size is set from your computer, it overrides the paper size setting in the control panel.

Custom paper sizes

If you want to choose a paper size that is not included in the list of standard paper sizes, there are various different ways to specify it.

Use the Windows printer driver

You can create and save custom paper sizes to suit your requirements.

1. Go to **Basic> Document size**.
2. Open the drop-down list and scroll down to the **(+)Create** section.
3. Enter the name, units, and size of the new paper custom size.
4. Tap the **Ok** button.

Custom paper sizes created with the printer driver have the following characteristics:

- The paper size is permanent and does not disappear if the driver is closed or the computer is turned off.
- The paper size is local to the printer queue and not seen from other printer queues in the same computer.

- In Domain server networks, the paper size is local to the computer and not seen from other computers sharing the printer queue.
- In Workgroup networks, the paper size is shared among all the computers that share the printer queue.
- If the printer queue is deleted, the paper size is deleted with it.

Use Windows forms

Unrestricted users can create a new Windows form.

1. From the **Start** menu or the control panel, tap **Printers > File**, and select **Server Properties**.
2. In the **Forms** tab, check the **Create a new form** box.
3. Enter the name and dimensions of the new paper size. Leave the margins as 0.00.
4. Tap the **Save form** button.
5. Go to the printer driver and select the document size.
6. Select your new paper size from the group of **Custom sizes**.

Paper sizes created with Windows forms have the following characteristics:

- The paper size is permanent and does not disappear if the driver is closed or the computer is turned off.
- Restricted users cannot create paper forms. The **manage documents** role in the Windows Active Directory is the minimum required.
- The paper size is local to the computer and is seen in all the printer queues created on the computer that support paper that size.
- If a printer queue is shared, this paper size appears in all the client's computers.
- If a printer queue is shared from another computer, this paper size **doesn't** appear on the driver's document size list. A Windows form in a shared queue must be created in the server.
- If the printer queue is deleted, the paper size does not disappear.

Use Mac OS X printer driver

You can manage paper custom sizes from the driver.

1. Go to the **Print** dialog.
2. Select **Paper Size>Manage Custom Sizes**.

Select margins options

By default, the printer leaves a 5 mm (0.2 in) margin between the edges of your image and the edges of the paper. However, you can change this behavior in the following way:

- **In the Windows driver dialog:** Go to **Basic > Margin Layout**.
- **In the Mac OS X Print dialog:** Select the **Margins/Layout** panel.

At least some of the following options appear:

- **Standard or Use application settings.** Your image will be printed on a page of the size you have selected, with the default margin between the edges of the image and the edges of the paper. The image should be small enough to fit between the margins.
- **Oversize.** You should load paper that is larger than the size you selected in the application or driver. If you cut off the margins after printing, you will be left with a page of the size you selected, with no margins remaining between your image and the edges of the paper. This is useful when you want your image to cover the whole area of the paper.
- **Clip Contents By Margins.** Your image will be printed on a page of the size you have selected, with the default margin between the edges of the image and the edges of the paper. In this case, if the image is the same size as the page, the printer assumes that the extreme edges of the image are either white or unimportant, and do not need to be printed. This may be useful when your image already contains a border.

Print on loaded paper

You can print a job on whichever substrate is loaded in the printer.

- **In the Windows driver dialog:** Select **Use printer settings** in the **Paper Type** option of your printer driver.
- **In the Mac OS X Print dialog:** Select the **Paper/Quality** panel, then in the **Paper Type** drop-down list, select **Any**.



NOTE: **Use printer settings** is the default **Paper Type** selection.

Rescale a print

You can send an image to the printer at a certain size but tell the printer to rescale it to a different size (normally larger). This may be useful:

- If your software does not support large formats
- If your file is too large for the printer's memory; in which case you can reduce the paper size in your software and then scale it up again using the control panel option

You can rescale an image in the following ways:

- **You can rescale an image from the Windows driver dialog:** Go to the **Advanced > Scale**.
 - By selecting a paper size, the image size is adjusted to the paper size you have selected. For example, if you have selected ISO A2 and you print an A3-sized image, it is enlarged to fit the A2 paper. If the ISO A4 size is selected, the printer reduces a larger image to fit the A4 size.
 - The **percentage of actual size** option enlarges the printable area of the original paper size by the percentage indicated, and then adds the margins to create the output paper size.
- **In the Mac OS X Print dialog:** Select the **Paper Handling** panel, then **Scale to fit paper size**, and select the paper size to which you want to scale the image. If you want to increase the size of the image, make sure that the **Scale down only** box is unchecked.

If you are printing to a single sheet, you must ensure that the image fits onto the sheet, if not the image will be clipped.

Print a draft

You can specify this to save time and cost.

- **In the Windows driver dialog:** Go to **Print quality** and select **Fast**.

You can specify even faster draft-quality printing by using Economode, as follows. This is intended mainly for documents containing only text and line drawings:

- **In the Windows driver dialog:** Go to **Advanced > Color and quality** and check **Economode**.
- **In the Mac OS X Print dialog:** Go to the **Paper/Quality** panel and move the print-quality slider to the extreme left (**Speed**).

High-quality printing

For unrivaled image quality.

- **In the Windows driver dialog:** Go to **Print quality** and select **Best**.
- **In the Mac OS X Print dialog:** Go to the **Paper/Quality** panel and move the print-quality slider to the extreme right (**Quality**).

If you have a high-resolution image

You can improve print sharpness when using glossy paper.

If your image has a resolution greater than the rendering resolution (which you can see in the **Custom Print Quality Options**), print sharpness may be improved by selecting the **Maximum Detail** option.

This option is available only if you are printing on photo paper.



NOTE: The **Maximum Detail** option results in slower printing with photo papers, but it does not increase the amount of ink used.

Use paper economically

You may be able to save some of your roll paper by removing blank areas and/or by image rotation.

- **In the Windows driver dialog:** Go to **Advanced > Output>Remove blank areas and enable the setting**.
You can also select one of the **Rotation** options.
- **In the Mac OS X Print dialog:** Go to **Finishing panel > Remove Blank Areas**.

Use ink economically

There are some recommendations you can follow to save ink.

- For draft prints use plain paper, set **Print quality** to **Economode**.
- Clean the printhead only when needed. Cleaning the printhead can be useful, but it uses a small amount of ink.
- Leave the printer permanently turned on so that it can maintain the printhead in good condition automatically. This regular printhead maintenance uses a small amount of ink. However, if it is not done, the printer may need to use much more ink later to maintain the printhead.
- Wide prints make more efficient use of ink than narrow prints, because printhead maintenance uses some ink, and its frequency is related to the number of passes made by the printhead.

Printing in grayscale or black-and-white

There are a number of ways to convert all the colors in your image to shades of gray.

- **In your application program:** Many applications provide this option.
- **In the Windows driver dialog:** Go to **Basic > Color mode** and tap **Grayscale**. Only black ink is used to print, except if the paper loaded is glossy, in which case colored inks are used to compose the gray shades. You can also select **Pure black and white** for black and white output only, with no gray shades. In this case only black ink is used to print. The **Pure black and white** option is not supported when you print on glossy paper.
- **In the Mac OS X Print dialog:** Go to the **Color Options** panel and from the **Mode** drop-down list, select **Grayscale**. Only black ink is used for printing, unless the paper loaded is glossy, in which case the other inks are used to compose gray shades. You can also select **Pure black and white** for black and white output only, with no gray shades. In this case, only black ink is used for printing. The **Print in pure black and white** option is not supported when printing on glossy paper.

Print from USB flash drive

Print an image on a USB flash drive directly to the printer using the control panel (only available on the MFP version of this printer).

1. Insert the USB flash drive containing the image or images that you want to print into the printer's USB port.
2. From the control-panel home screen, tap the **Print** icon .
3. Tap **Print from USB**.
4. Select the file to print.
5. Tap **USB settings** at the bottom right to select the print settings for the job. The printing parameters for the task include the number of copies, color options, print quality, output size, paper source, and print margins.
6. Tap **Print** to print the job.

Print using Wi-Fi Direct

With Wi-Fi Direct, you can print wirelessly from a computer, smart phone, tablet, or other wireless-capable device—without connecting to an existing wireless network.

Guidelines for using Wi-Fi Direct



There are essential prerequisites to using Wi-Fi Direct.

- Make sure your computer or mobile device has the necessary software.
 - If you are using a computer, make sure you have installed the HP printer software.
 - If you have not installed the HP printer software on the computer, connect to Wi-Fi Direct first and then install the printer software. Select **Wireless** when prompted by the printer software for a connection type.

- If you are using a mobile device, make sure you have installed a compatible printing app. For more information, visit the HP Mobile Printing website at <http://www.hp.com/go/mobileprinting>. If a local version of this website is not available in your country/region or language, you might be directed to the HP Mobile Printing website in another country/region or language.
- Make sure Wi-Fi Direct for your printer is turned on.
- Up to five computers and mobile devices can use the same Wi-Fi Direct connection.
- Wi-Fi Direct can be used while the printer is also connected to a network using a wireless connection.
- Wi-Fi Direct cannot be used to connect a computer, mobile device, or printer to the Internet.



Turn on Wi-Fi Direct

You can turn on Wi-Fi Direct directly from the control panel, or alternatively from the EWS.

1. From the printer control panel, tap **Menu**  > **Settings**  > **Network** > **Wi-Fi Direct**.
2. If the display shows that Wi-Fi Direct is **Off**, tap **Wi-Fi Direct** and then switch it on.
3. You can also turn on Wi-Fi Direct from the Embedded Web Server. For more information about using the Embedded Web Server, see [Access the Embedded Web Server on page 19](#).

Change connection method

You can change the Wi-Fi Direct connection method, and choose between automatic and manual.

1. From the printer control panel, tap **Menu**  > **Settings**  > **Network** > **Wi-Fi Direct**.
2. Tap **Connection Method** and then select **Automatic** or **Manual**:
 - a. If **Automatic** was selected during Wi-Fi Direct setup on the printer, the mobile device automatically connects to the printer.
 - b. If **Manual** was selected during the Wi-Fi Direct setup on the printer, acknowledge the connection on the printer display or enter the printer PIN on your mobile device. The PIN is provided by the printer when a connection attempt is made.

Print from a wireless-capable mobile device that supports Wi-Fi Direct

Make sure you have installed the latest version of HP Print Service Plugin on your mobile device.



NOTE: If your mobile device does not support Wi-Fi, you are not able to use Wi-Fi Direct.

1. Make sure you have turned on Wi-Fi Direct on the printer.
2. Turn on Wi-Fi Direct on your mobile device. For more information, see the documentation provided with the mobile device.
3. From your mobile device, select a document from a print enabled application, and then select the option to print the document.

The list of available printers appears.

4. From the list of available printers, choose the Wi-Fi Direct name shown such as **DIRECT-**-HP DesignJet T850 Printer series** (where ** are the unique characters to identify your printer), and then follow the onscreen instructions on the printer and your mobile device.
5. Print your document.

Print from a wireless-capable mobile device that does not support Wi-Fi Direct

Make sure you have installed a compatible printing app on your mobile device.

1. Make sure you have turned on Wi-Fi Direct on the printer.
2. Turn on the Wi-Fi connection on your mobile device. For more information, see the documentation provided with the mobile device.

 **NOTE:** If your mobile device does not support Wi-Fi, you are not able to use Wi-Fi Direct.

3. From the mobile device, connect to a new network. Use the process you normally use to connect to a new wireless network or hotspot. Choose the Wi-Fi Direct name from the list of wireless networks shown such as **DIRECT-**-HP DesignJet T850 Printer series** (where ** are the unique characters to identify your printer).
4. Enter the Wi-Fi Direct password when prompted.
5. Print your document.

Mobile printing

Introduction

You can print to your printer from many mobile devices and from almost any location.

The main method of Mobile Printing is: Direct printing by connection to the same network.

Your printer can be connected to the HP Cloud, providing various benefits. See [Choose which connection method to use on page 15](#) for more information.

See the HP website at the following link: <http://www.hp.com/go/designjetmobility> for more detailed information.

 **IMPORTANT:** The printer must be connected to a network with Internet access: connect an Ethernet cable.

 **IMPORTANT:** In order to print/scan from mobile devices, **Bonjour**, **IPP/IPPS** and **Remote scan** protocols must be enabled in the Embedded Web Server (**Network > Advanced Settings**).

Print from Android

You can add and manage your device's print services from your Android Settings: **Settings**  **> Connected Devices > Connection Preferences > Printing** (exact location may vary depending on Android OS version).

 **NOTE:** Printing is only available from applications that offer printing or sharing.

Print and scan using the HP app

Stay productive and organized with the HP app. Print, scan and share your HP printer. Install the HP app on all your devices and save time for what matters.

You must have Android 9.0 or later.

If it is not already installed on your device, download and install the HP app from the Google Play store at the following link: <https://play.google.com/store/apps/details?id=com.hp.printercontrol>.

To have access to all the HP app's features, connect your printer to HP Cloud and log in using your HP Credentials.

Make sure your device and printer are operating on the same network and follow the steps below:

To print using the HP app:

1. Open the HP app and select your printer.
2. Select whether you want to print documents or photos from your local device, or link your Google Drive, Dropbox, or other accounts to access your content.
3. Use the edit options to adjust quality, color, and other settings if you wish to make such adjustments.
4. Tap **Print** and collect your printed documents.

To scan using the HP app:

1. Place the document that you want to scan on the scanner area.
2. Open the HP app and start scanning from it.
3. Once the scanned document is received in the HP app, you can either store the document in your mobile device, send it by email, or upload it directly to your preferred cloud repository.



NOTE: Scanning is only available in MFP models.

Print using the HP Print Service plugin

You must have Android 6.0 or later.

If it is not already installed on your device, download, install, and enable the HP Print Service plugin from the Google Play store at <https://play.google.com/store/apps/details?id=com.hp.android.printservice>.

To use the plugin, follow the steps below:

1. Open the document or photo you want to print, tap the **Menu** icon, then tap **Print**.
2. Choose your printer from the list. Printers discovered by the HP Print Service plugin will appear with the HP logo.
3. Check the print settings, then tap **Print**.

Alternatively, for document types PDF, JPEG, and PNG, you can use the Android **Share** button and select the **HP Print Service** plugin from the list of options.

Print using the Mopria Print Service

You must have Android 5.0 or later.

If it is not already installed on your device, download, install, and enable the Mopria Print Service from the Google Play store at <https://play.google.com/store/apps/details?id=org.mopria.printplugin>.

To use Mopria, follow the steps below:

1. Open the document or photo you want to print, tap the **Menu** icon, then tap **Print**.
2. Choose your printer from the list. Printers discovered by the Mopria Print Service will appear with the Mopria Alliance logo.
3. Check the print settings, then tap **Print**.

Alternatively, for document types PDF, JPEG, and PNG, you can use the Android **Share** button and select **Mopria** from the list of options.

For more information, visit the Mopria website at <https://mopria.org/>.

Print using the Android default print service

You must have Android 12.0 or later.

The Android default print service comes pre-installed on Android devices, but is enabled only if no other compatible print service is installed, such as the HP Print Service plugin or the Mopria Print Service.

To use the default service, follow the steps below:

1. Open the document or photo you want to print, tap the **Menu** icon, then tap **Print**.
2. Choose your printer from the list. Printers discovered by the default print service will appear with a generic printer logo.
3. Check the print settings, then tap **Print**.

Print from Apple iOS



NOTE: Printing is only available from applications that offer printing or sharing.

Print and scan using the HP app

Stay productive and organized with the HP app. Print, scan and share your HP printer. Install the HP on all your devices and save time for what matters.

You must have iOS/iPadOS 15.0 or later.

You can download the HP app from the iTunes website at following link: <https://itunes.apple.com/app/id469284907>

To have access to all the HP app's features, connect your printer to HP Cloud and log in using your HP credentials.

Make sure your device and printer are operating on the same network and follow the steps below:

To print using the HP app:

1. Open the HP app and select your printer.
2. Select whether you want to print documents or photos from your local device, or link your Google Drive, Dropbox, or other accounts to access your content.

3. Use the edit options to adjust quality, color, and other settings if you wish to make such adjustments.
4. Tap **Print** and collect your printed documents.

To scan using the HP app:

1. Place the document that you want to scan on the scanner area.
2. Open the HP app and start scanning from it.
3. Once the scanned document is received in the HP app, you can either store the document in your mobile device, send it by email, or upload it directly to your preferred cloud repository.

Print using AirPrint

iOS printing is enabled through AirPrint. You must have iOS 7.0 or later.

1. Open the document or photo you want to print and press the **Share** button.
2. Swipe the screen to reveal the **Print** button and press it.
3. Check the print settings, then press **Print**.

Print from Chrome OS

Printing is only available from applications that offer printing or sharing.

Print using Chrome OS Native Print

With the latest ChromeOS versions, you can use native printing capabilities for basic printing without having to install additional software.

1. Choose your content. Open the document or photo you want to print, tap the **menu icon** and select **Print**.
2. Choose your printer. Select from the list of printers that appears. Printers discovered by ChromeOS Native Print will appear with a generic printer logo.
3. Confirm that the correct printer and print settings are selected. Tap **Print** and collect your printed documents.

For more information, visit the Google website at the following link:

<https://support.google.com/chrome/a/topic/9045842>.

Mobile specifications

The HP app requires you to have an Internet connection.

Print and scan functionalities require that the mobile device and printer be on the same network.



NOTE: OS versions supported may vary in the future.

Reprint (Only HP DesignJet T950)

You can reprint from the control panel.

1. Tap the Jobs icon  on the home screen to view the job queue on the control panel. The job queue includes jobs that have already been printed.

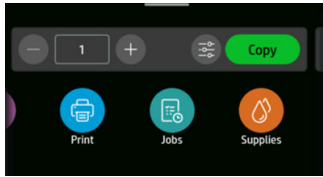

2. Scroll down to the **History** section to see the printed jobs.

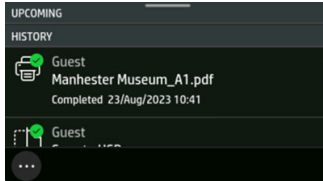

3. Select a printed job.

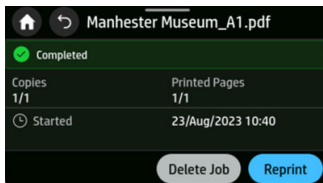

Only the number of copies can be modified when reprinting a job. The reprint feature is available from the EWS from **Jobs** and then under **Jobs Queue**. It can be enabled or disabled from the Embedded Web Server by selecting **Jobs** and then **Jobs settings**. This requires being logged in as an admin user.

6 Scanning (only MFP)

MFP models have an integrated color scanner capable of scanning images of the same width that the printer can print. Scan resolution is up to 600 dpi in RGB color with 24 bits per pixel, or grayscale with 8 bits per pixel, or black and white with 1 bit per pixel.

Quick Sets

A Quick Set is a named group of settings with defined default values that help you to be more efficient.

Quick Sets are convenient for inexperienced users, and can be used to scan, copy, and print jobs.

Factory Quick Sets

The printer comes with some factory Quick Sets already defined, designed to support typical user requirements.

User Quick Sets

Quick Sets can be defined by a user and created or modified with the Embedded Web Server.

For information about the Embedded Web Server, see [Access the Embedded Web Server on page 19](#)

To create or modify a user Quick Set, tap **Quick Sets** in the menu at the left side of the Embedded Web Server window.

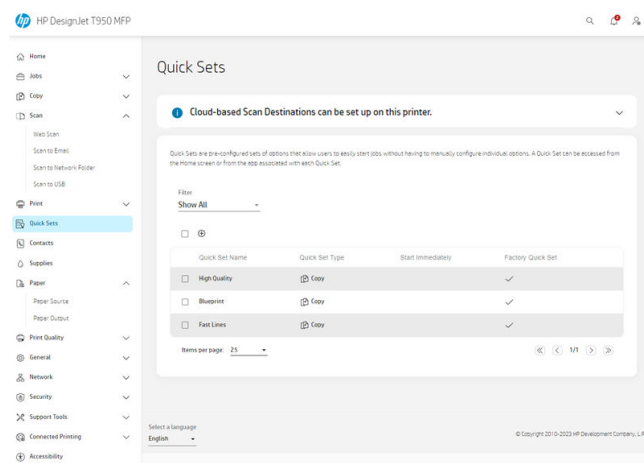

Your own Quick Sets can be duplicated, edited temporarily or permanently, and deleted. Factory Quick Sets can only be duplicated.

To add a new Quick Set:

1. Tap the **Add** icon . A window opens to create a new Quick Set to scan, copy, or print jobs.

2. Select from the drop-down list where the new Quick Set will appear. Choose from: **Copy**, **Network folder**, **USB drive**, or **Print from network folder**, then tap **Next**.

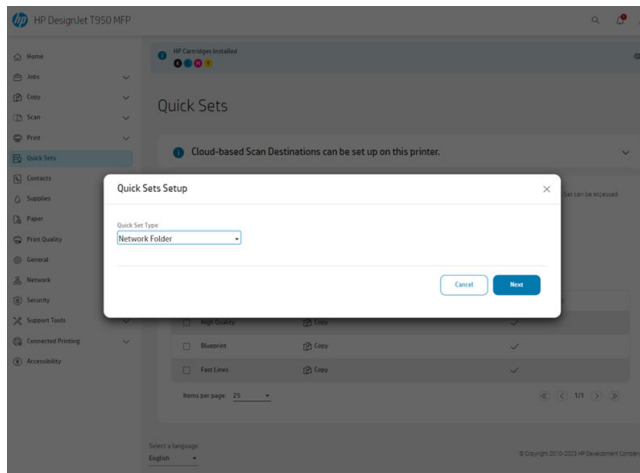

3. Give the new Quick Set a **Name** and a **Description**. When ready, tap **Next**.

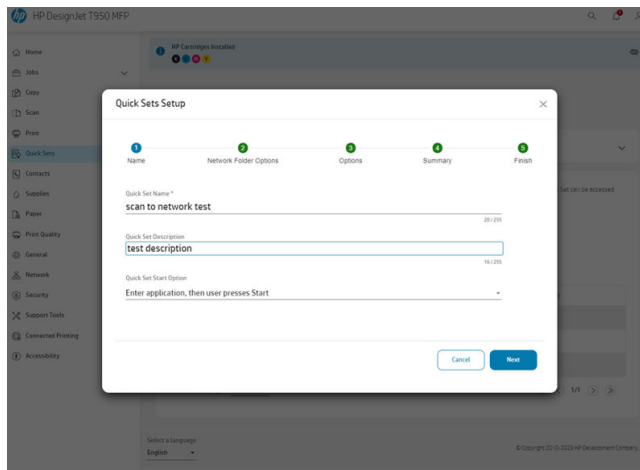

4. Select **Use the following credentials**, then tap **Next**.

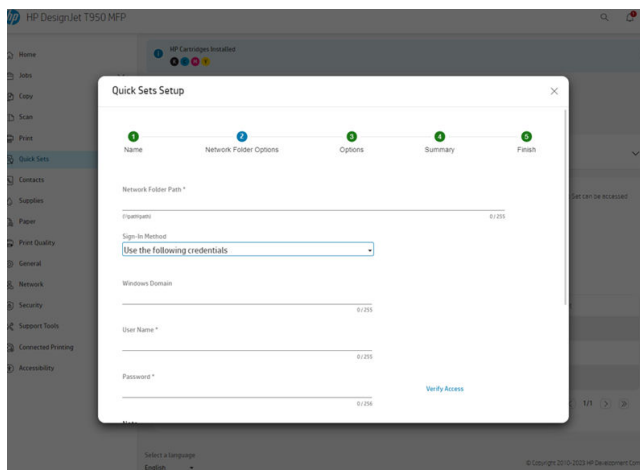

5. Select the **Input options** you require, then tap **Next**.

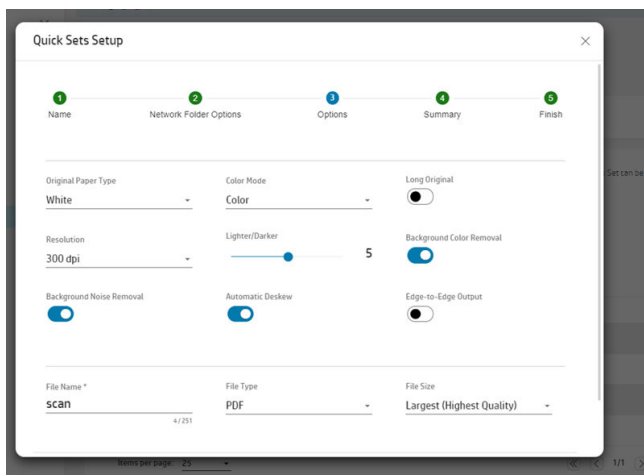

6. A summary of the Quick Set appears. Tap **Next** to save the Quick Set and continue.

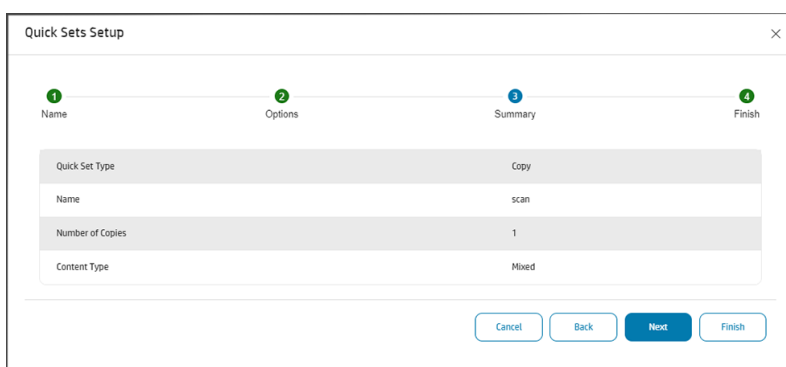

7. The Quick Set is added and now available to use. Tap **OK** to finish.

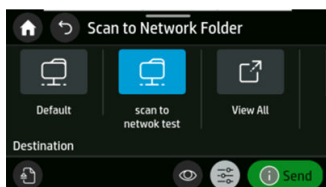

Paper types suitable for scanning

Paper categories supported for your HP scanner.

HP recommends:

- **White paper:** Any matte original printed with inkjet technology. For instance, anything printed with this printer on any of these paper types: HP Universal Inkjet Bond Paper, HP Coated Paper, HP Heavyweight Coated Paper, plain paper.
- **Translucent paper:** Semi-transparent tracing papers (> 65 g/m²), including HP Natural Tracing Paper, HP Vellum, and HP Translucent Bond.

- **Blueprints:** For scanning blueprint originals with optimum results, in grayscale only. This option greatly enhances the contrast of the resulting image.

The following paper types are not supported by the scanner:

- Film
- Backlit material
- Cling material
- Translucent paper (< 65 g/m²)

⚠ WARNING! Do not use documents with staples or rough surfaces/materials that can damage the scanner glass.

Scan widget

The scan widget allows you to quickly start scanning with predefined settings and send your scan to a network folder.

It can be found on control panel's home screen by sliding the copy widget to the left.

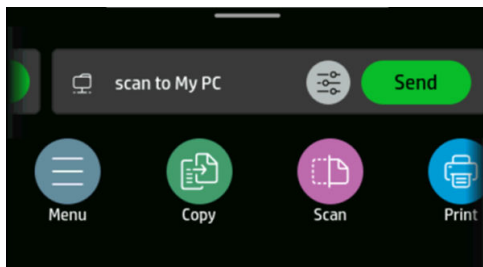

To start the scanning process, click the send button. See [Scan to network setup process on page 58](#) for more information on the complete process.

Tap the Settings icon  to edit defined settings. See [Scan settings on page 56](#) for more information.

NOTE: The scan widget settings used to scan and the folder where the job is sent to can be changed in the Embedded Web Server: **Scan > Scan to network folder**.

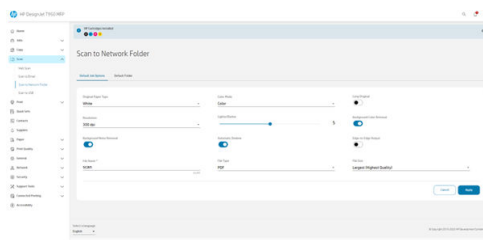

IMPORTANT: Before using the scan widget, a network folder needs to be configured. See [Scan to network setup process on page 58](#).

Scan destinations

The scanner is capable of scanning directly to different destinations.

You can scan to the following:

- To network folder
- To email address
- To USB flash drive

You can start a scanning process in two ways:

- **At the control panel:** select **Scan** .

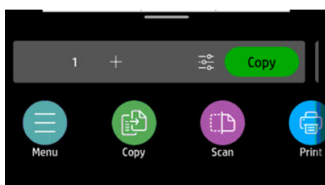

Then select where you would like to store the scanned image.

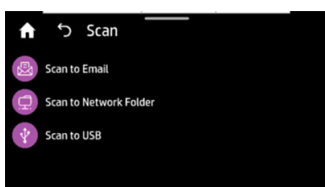

- **Feed the document directly:** Load the sheet with the printed side facing upwards (you can also load the sheet before step 1, if you prefer).

Align the center of the sheet approximately with the center of the scanner. Use the standard size markings to help you.



 **NOTE:** The maximum length of paper that the scanner can scan depends on the paper width, among other options such as scan resolution. An alert is displayed if the maximum length is exceeded.

Push the sheet into the insertion slot until you feel it contact the rollers. The scanner will automatically grab the sheet and move it into position for scanning. If you feel that the sheet has loaded badly and you want to try again, you can pull it out manually.

 **IMPORTANT:** Do not try to feed the scanner while the printer is printing, as only one action can be done at a time. Paper will not be accepted by the scanner during printing.

At the control panel, go to the home screen and select **Scan** , then select where you would like to store the scanned image:

- **Into an email:** Before using this option, make sure the setup process has been completed. See [Scan to email setup process on page 57](#). If the setup process has not been done, the following message appears on the control panel:

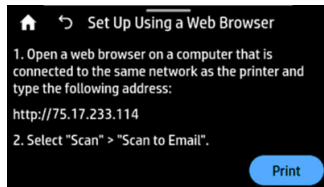

If you have already configured the email server in the Embedded Web Server, you must provide the email address(es) to which the scanned job will be sent.

Scan to email user interface options:

- Sender
- Send to:
 - Contact
 - Group
 - Addresses

For further information on the scan settings, see [Scan settings on page 56](#).

Tap **Start Scan** to start the scanning process.

 **NOTE:** Before starting the process, make sure you have followed the **Scan to email setup** process. The **Scan to email setup** has to be done from the Embedded Web Server. For more information, go to **Scan to email setup** process on [Scan to email setup process on page 57](#).

 **NOTE:** If the scanned image is larger than the maximum permitted, the printer will ask you if you want to try to send it anyway. If you want to change this option, go to the Embedded Web Server and select **General / Email Servers > Maximum size of email**.

- **To a network folder:** In this case, you must choose a folder accessible through the network.

To create and/or change the folder options, go to the Embedded Web Server, then **Scan**  > **Scan to network folder > Default folder**, or you can create a network folder quick set.

A security PIN can be associated with each folder; check Network folder setup on [Scan to network setup process on page 58](#).

- Once the Scan to networks quick set has been created, you can go to the home screen and select the **Scan** icon :

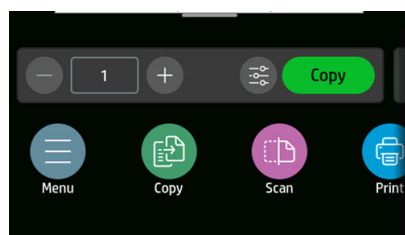

- Then, **Scan to Network Folder..**

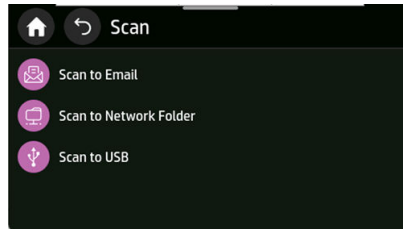

- You can select a quickset.

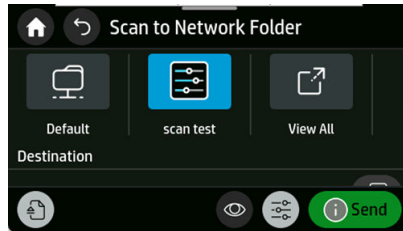

Tap the **Settings** icon  to change scan to network folder settings. For further information on settings, go to [Scan to network setup process on page 58](#).

Tap **Start Scan** to start the scanning process.

 **NOTE:** Before starting the process, make sure you have followed the **Scan to Network folder setup** process. The **Scan to Network folder setup** has to be done from the Embedded Web Server. For more information, go to **Scan to Network folder setup** process on [Scan to network setup process on page 58](#).

- **To USB:** The file is saved in PDF, JPEG, or TIFF format using an automatically generated file name if you have not given it one.

Scan to USB user interface options:

- File name
- File type
- Resolution
- Color mode

To access to all scan settings, click on the setting icon . For further information on settings, go to [Scan settings on page 56](#).

Tap **Start Scan** to start the scanning process.

- **Scanning from a mobile device:** You can also scan from your smartphone or tablet.

Scan settings

Some of the default scan settings are displayed. Tap **Settings**  to see the complete list of settings, and check in particular that the original type setting corresponds to the paper type that you intend to scan.

- **Original paper type:**
 - **a) White**
 - **b) Blueprint:** for scanning blueprint originals with optimum results. This option converts to grayscale and inverts the colors, if needed, producing a white background with black lines.
 - **c) Translucent paper:** is a mode specifically for scanning NTP, vellum, and other translucent papers.
- **Color options:** allows you to choose color, grayscale, or black and white scanning.
- **Resolutions:** allows you to specify the scan resolution (200, 300, 600 dpi)
- **Long original:** allows you to scan up to 8 meters (26.25 feet) long originals.
- **Lighter/Darker:** allows you to modify the lightness of the scan using a slider.
- **Background color removal:** cleans the color in the original background.
- **Background noise removal:** clears the noise on the original background.
- **Scan edge-to-edge output:** do not crop the scan to the original edges. It is **Off** by default.
- **Automatic deskew:** corrects the skew automatically. It is **On** by default.
- **File type:** Format allows you to specify the format of the file in which the scanned image will be saved: TIFF, JPEG, or PDF.
- **File name**
- **File size:** allows you to specify the level of compression: High (the default level), Medium, or Low. This option is available if the format is JPEG or PDF.

To configure default scan settings, go to the EWS, then **Scan**, **Scan to email**, **Scan to network folder**, or **Scan to USB**.

 **NOTE:** The 'Scan to network' widget uses the settings defined in the EWS under **Scan to network folder**.

Scan options setup process

A scanned image may be saved to a USB flash drive, a network folder, or an email message. The USB flash drive options require no preparation, but the other options will not work until they have been set up.

To set up the different scan options, go to the Embedded Web Server in your computer. Access the Embedded Web Server by typing the printer's IP address into your browser. Find your printer's IP address on your printer's Home screen, on the dashboard. Once in the Embedded Web Server, look for the option you would like to set up.

 **NOTE:** Visit <https://hp.com/scanhelp> for further help on the scan from the control panel options.

Scan to email setup process

To set up **Scan to email**, follow the process in the Embedded Web Server. Go to **General > Email Servers**.

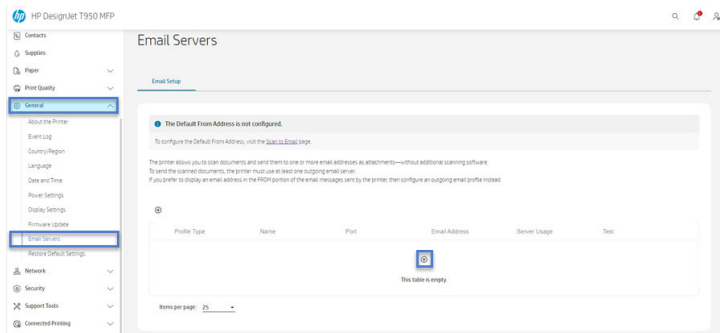

Outgoing email settings

- **To:** select the default address destination
- **From:** define the default email address for the sender
- **Default from:** specify the default email name
- **Default display name:** specify the default name for the email sender
- **SMTP Server:** the IP address of the outgoing mail server (SMTP) that will process all email messages from the printer. If the mail server requires authentication, email notifications will not work.
- **SMTP Port:** set the default SMTP port number of your outgoing email server
- **Maximum size of email:** defined by your email server
- **Server Authentication:** depends on your email server settings

Scan to network setup process

A scanned image may be saved in a network folder. The USB flash drive option requires no preparation, but the other options will not work until they have been set up. To set up the **Scan to network folder**, first you have to create a folder on your computer.

1. Create a folder on a computer that the scanner can access through the network. See [Example: Create a scan-to-network folder under Windows on page 60](#) or [Example: Create a scan-to-network folder under Mac OS X on page 62](#).
2. Create a user account on the same computer for the printer.
3. Change the sharing options of the folder so that it is shared with the 'scanner user', and assign full control of the folder to that user.

4. Create a share name for the folder.

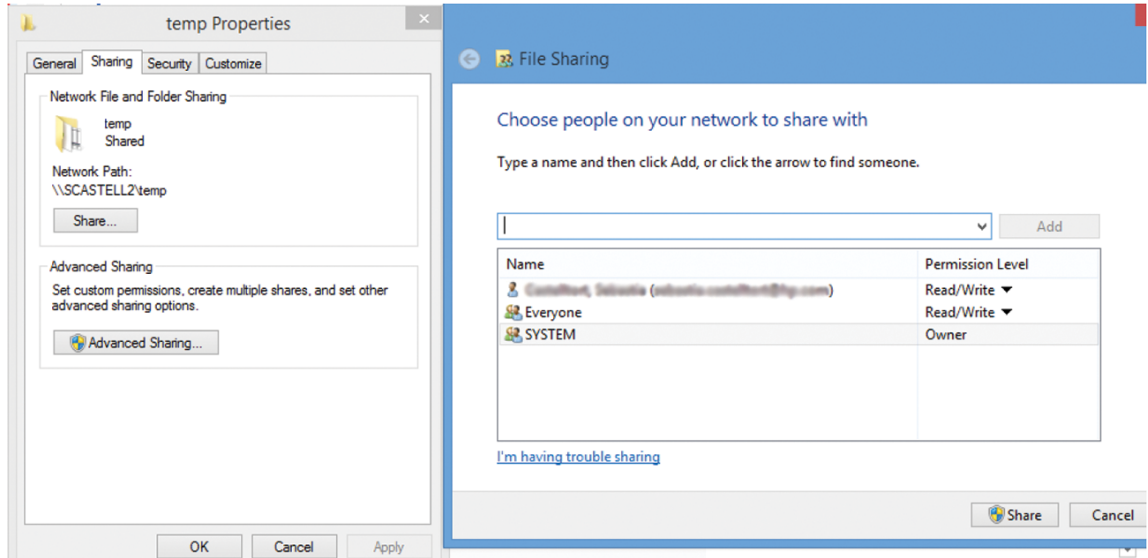

Once the shared folder is created, go to the Embedded Web Server and follow the instructions under the Scan to network folder setup process.

5. In the printer's Embedded Web Server, select the **Jobs** tab and then **Network folder**.

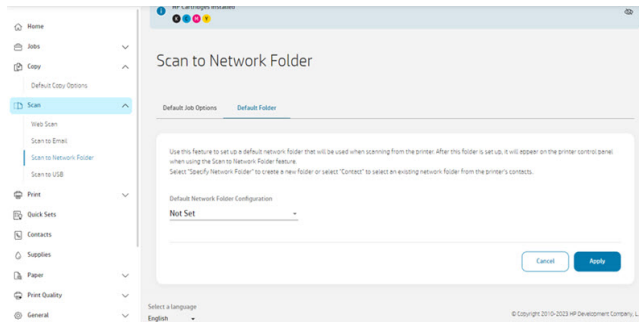

6. Select an existing profile or  to create a new network folder profile.

7. Write a name for the folder and type the network path.

- **Display Name** is displayed in the control panel when you are choosing the scan destination. It may be different from the network or FTP folder name.
- **Network Path** should contain the network name of the remote computer.

The server and folder names are used to connect to the shared folder by building a network folder path as follows: `\\server name\folder name`

For a **Network Path**, enter the name or IP address of the remote computer and the name of the shared folder.

Select **Next** to continue.

8. Define **Log-in Authentication** settings.

- **User name** should contain the name of the 'scanner user'.

- **Password** should contain the password of the 'scanner user'.

Type the user name and password of the 'scanner user' that you have already created on the remote computer. Leave the user domain field empty unless the user is a member of a Windows domain. If the user is only a local user of the remote computer, leave the field empty. You can use the name (instead of the IP address) in the server name field only if the shared folder is on a Windows computer in the same local network. This must be a simple name (up to 16 characters long) without a domain suffix (without any dots in the name). Fully qualified DNS domain names are not supported. If the product and the network folder are in different networks, or if the remote computer is not running Windows, then you must use the IPv4 address instead of the name of the remote computer. On IPv6 networks the IPv6 address is also supported.

Select **Next** to continue.

9. Define the **Setup Configuration** for files scanned to the network folder.

 **NOTE:** The scan settings defined for a folder, are exclusive for the setup folder.

10. Click **Add** to save the configuration.

 **NOTE:** If the product has already been configured for scanning to the network and you now want to use a different shared folder, click **Edit**.

From server/from printer

To be able to scan from server/from printer, you have to follow the Windows setup process defined for adding a device.

Look for **Devices and printers > Add a device** and follow the instructions.

Example: Create a scan-to-network folder under Windows

The printer has a feature that enables it to scan a document and save it to a network folder. You need an new account and dedicated folder set up on the remote computer.

1. Create a new user account for the 'scanner user' on the remote computer. You can use an existing user account for this purpose, but it is not recommended.
2. Create a new folder on the remote computer, unless you want to use an existing folder.
3. Right-click the folder and select **Properties**.

4. In the **Sharing** tab, click the **Advanced Sharing** button.

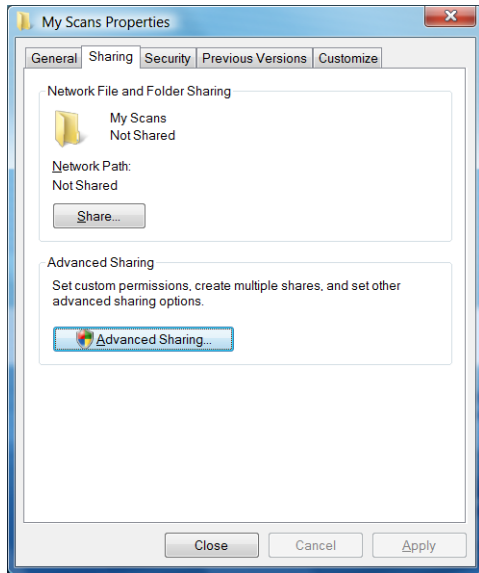

5. Check the **Share this folder** box.

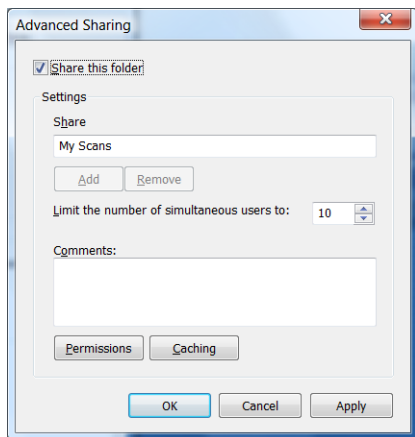

6. You need to ensure that the 'scanner user' has full read/write control over the shared folder. To do this, click **Permissions** and grant **Full Control** to the user (or to any suitable group that includes that user).

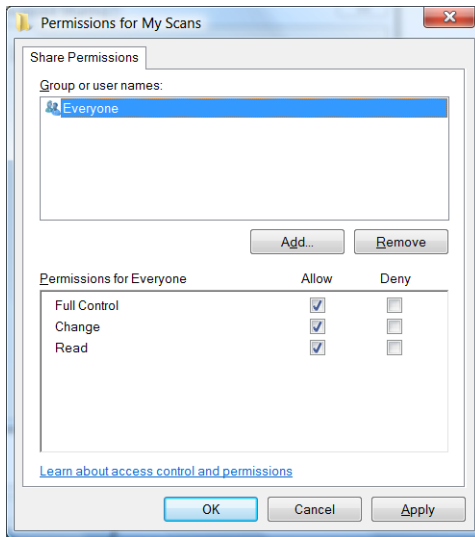

7. If there is a **Security** tab in the Properties window for your folder, then you must also grant the same user **Full Control** over the folder in the **Security** tab. Only some file systems such as NTFS require this.

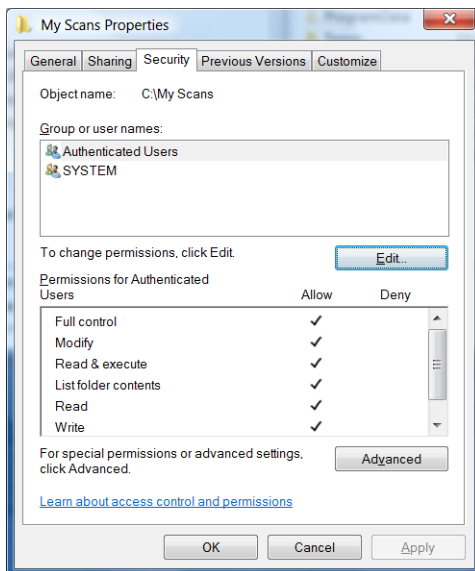

The 'scanner user' can now access the folder and write files to it. Next, you must configure the printer to send scans to the folder.

Example: Create a scan-to-network folder under Mac OS X

The printer has a feature that enables it to scan a document and save it to a network folder. You need a new account and dedicated folder set up on the remote computer.

1. Create a new user account for the 'scanner user' on the remote computer. You can use an existing user account for this purpose, but it is not recommended.

2. Create or choose a folder on the remote computer. By default, Mac OS X users have a **Public** folder that can easily be used for this purpose.
3. Open the **System Preferences** application and select the **Sharing** icon.

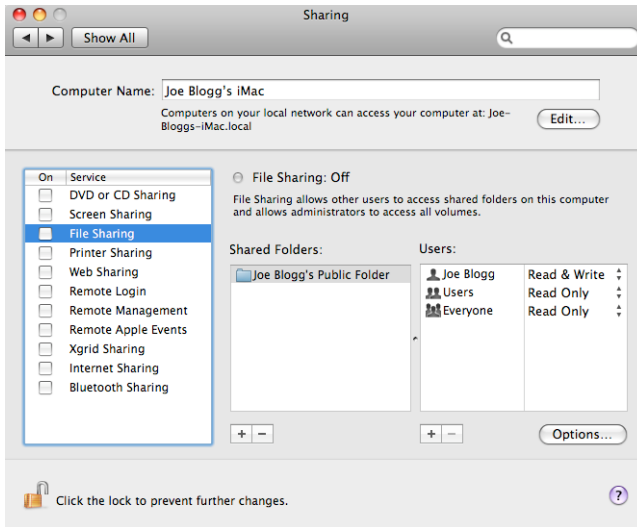

4. Make sure the 'scanner user' has **Read & Write** access to the folder.
5. Click **Options**.
6. Check the **Share files and folder using SMB** box, and make sure that the 'scanner user' is checked in the On column.

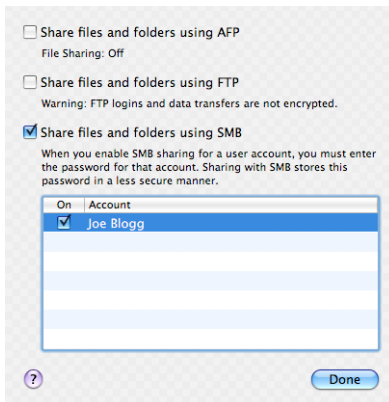

7. Click **Done**. You will now see file sharing enabled and Windows sharing on.

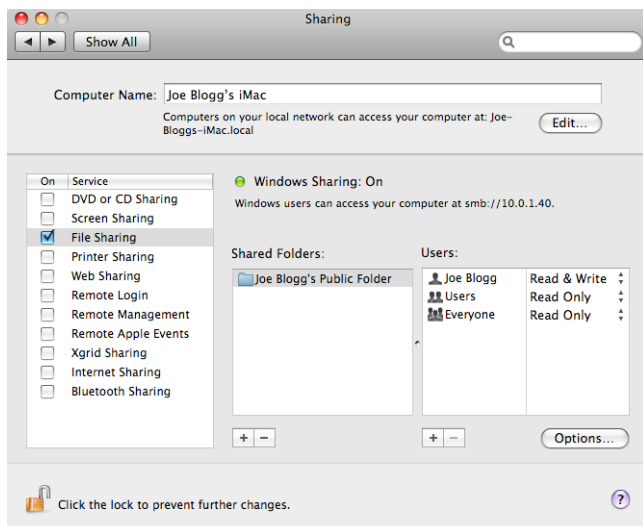

The 'scanner user' can now access the folder and write files to it. Next, you must configure the printer to send scans to the folder.

Scan from the HP app

You can also scan directly to your mobile device by using the HP app (available for Android and iOS).

For more information, see [Mobile printing on page 45](#).

Web scan

User can also scan from the Embedded Web Server.

From the Embedded Web Server, go to Web Scan and follow the instructions.

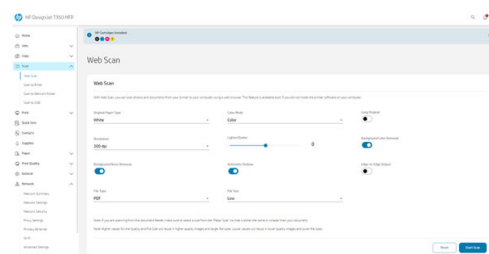

Scanning to the network folder using the widget

The scan-to-network-folder widget is a fast way to start a scan and send the document to a network folder.

With a document loaded in the scanner, tap the **Send** button  to start scanning it.



NOTE: If you need to change a setting before the scan starts, tap the **Options** icon .

The widget settings used to scan and the folder to which the job is sent can be changed in the Embedded Web Server. See [Access the Embedded Web Server on page 19](#). However, you will then need to restart the printer to see the settings updated in the widget.

7 Copying (only MFP)

Copy settings offer you a range of options to adjust, enhance, and alter (color), to ensure that the image is scanned and printed for optimum results. You can scan to fill the whole sheet by remove any cropping, correct skew, and even resize the copy to print at a desired size.

Copy

The function is easy to use and controlled from the control panel.

1. On the control panel, tap the **Copy** menu .

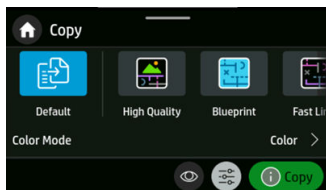

2. You can select a factory Quick Set or one you have created, or if needed, select each specific setting.
3. Select the suitable option for your document. The options are the following:
 - **Lines**
 - **Image**
 - **Mixed** (a document that has both images and lines, such as a map)
4. Select the number of copies that you want to make. You can choose a number ranging from 1 to 99. You can enter the number manually or select it from a slider.
5. Select the paper source you are going to copy to:
 - **Roll**
 - **Tray**
 - **Single sheet**
6. Select the quality of your copy. There are 3 different quality options: **Best, Normal, Draft**.
7. Tap **Copy**. The printer will prompt you to load the original document if you haven't already.



 **NOTE:** The maximum length of paper that the scanner can scan depends on the paper length and the scan resolution. An alert is displayed if the maximum memory is exceeded.

Push the sheet into the insertion slot until you feel it contact the rollers. The scanner will automatically grab the sheet and move it into position for scanning. If you feel that the sheet has loaded badly and you want to try again, you can pull it out manually.

 **IMPORTANT:** Do not try to feed the scanner while the printer is printing, as only one action can be done at a time.

Copy widget

The copy widget allows you to quickly start copying with predefined settings.

It can be found at the top of the control panel's home screen. See [Copy on page 66](#).

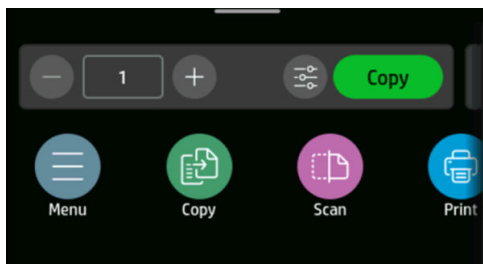

Tap on the (-) icon or (+) icon to edit the number of copies.

Click the Copy button to start the copying process. See [Copy on page 66](#) for more information on the complete process.

Tap the Settings icon  to edit defined settings. See [Copy settings on page 68](#) for more information.

 **NOTE:** The copy widget settings used to copy can be changed in the Embedded Web Server: **Copy > Default copy options**.

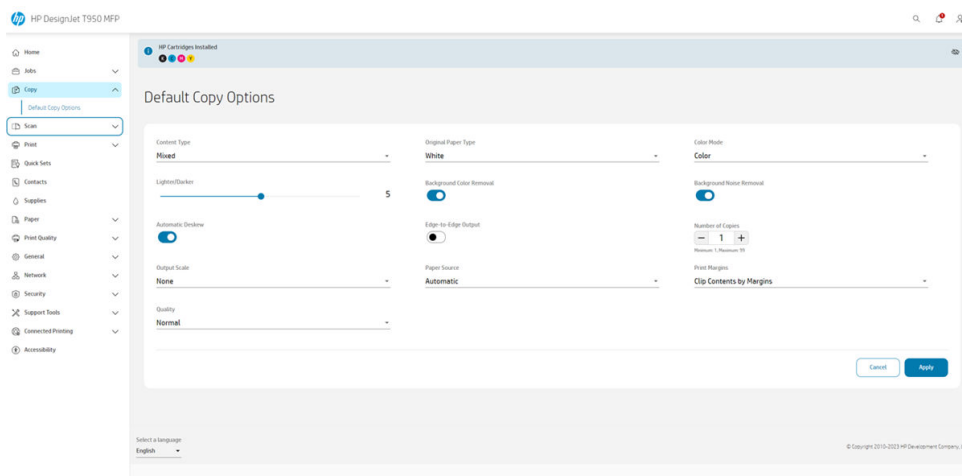

Copy settings

Some of the default copy settings are displayed. Tap **Settings** to see the complete list of settings.

Scan settings

- **Content type**
- **Lighter/darker** allows you to adjust the lightness of the copy.
- **Background noise removal** reduces image defects such as wrinkles.
- **Background color removal** reduces color defects in the original background.
- **Original Paper Type:** White, Blueprint, and Translucent
- **Color mode** allows you to specify the colors for your copy (color, grayscale, black and white).
- **Automatic Deskew** automatically corrects skew. It is **On** by default.
- **Edge-to-Edge Output** ensures the copy is not cropped to the edge of the original image. It is **Off** by default.

Printing settings

- **Copies:** To select the number of print copies.
- **Output Scale** allows you to resize the print. There are four options:
 - **None:** The original size is not scaled (default)
 - **Custom:** To resize the copy to a specific percentage
 - **Standard Sizes:** Resize to a specific standard size
 - **Loaded papers:** Resize to the size of one of the loaded papers
- **Paper Source** allows you to choose between Automatic (default), Roll, Tray or Single Sheet when printing.
- **Copy Margins** allows you to decide how to manage the printer margins. You can print the scanned image as is and add the margins or you can clip the image with the printing margins (Add to Contents, Clip to Contents).
- **Quality** defines the copy resolution and print quality.

Defaults

To define default copy settings, go to the EWS > Copy > Default Copy Options.



NOTE: Default copy options are used by the copy widget.

Copy from the widget

The copy widget is a fast way to start a copy.

With a document loaded in the scanner, tap on the **Copy** button to quickly start copying. The number of copies can be defined for the copy widget.

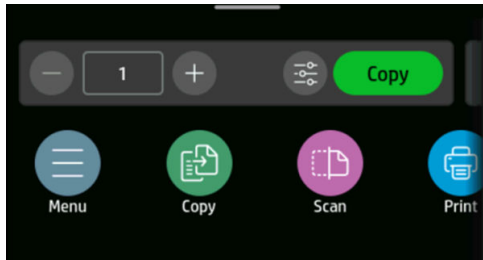

8 Quick Sets

A Quick Set is a named group of settings with defined default values.

Quick Sets help you be more efficient and are convenient for less experienced users. They offer a 'one click' action to scan, copy, and print jobs.

Factory Quick Sets

The printer comes with some pre-defined factory Quick Sets, designed to support typical user requirements.

See [Launching Quick Sets on page 73](#) for more information.

Managing Quick Sets

Quick Sets can be managed from the Embedded Web Server.

Look for the **Quick Sets** option on the menu. See [Access the Embedded Web Server on page 19](#) for more information.

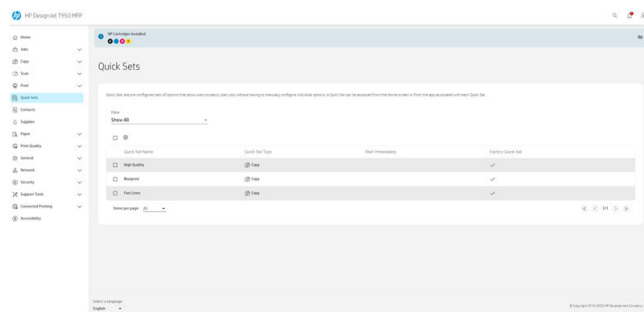

Depending on the permissions your printer has set, you can create, delete, edit, or view a Quick Set.

Creating a new Quick Set

Quick Sets can be created from the Embedded Web Server.

1. Tap the Add icon (+). A window opens to create a new Quick Set to scan, copy, or print jobs.

2. Select the new type of Quick Set from the drop-down list. Choose from **Copy**, **Email**, **Network Folder**, **USB Drive**, or **Print from USB**, then tap **Next**.

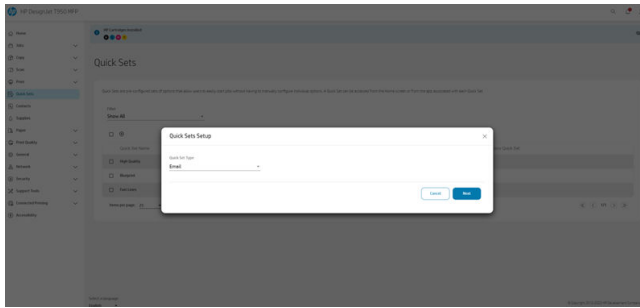

3. Give the new Quick Set a name, description, and choose the start option from the drop-down list, then tap **Next**.

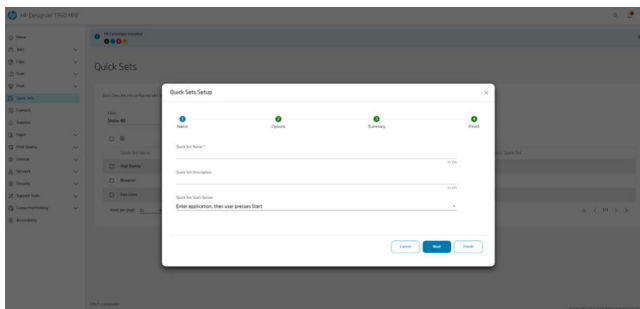

4. Select the input options you require, then tap **Next**.

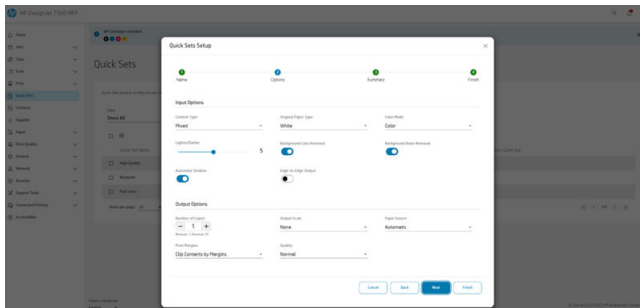

5. A summary of the Quick Set appears. Tap **Next** to save the Quick Set and continue.
6. The Quick Set is added and now available to use. Tap **OK** to finish.

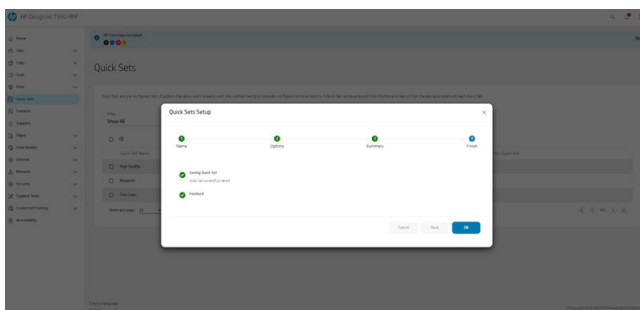

7. The new Quick Set will now appear in the list.

Editing a Quick Set

Quick Sets can be edited from the Embedded Web Server.

 **NOTE:** Factory Quick Sets cannot be edited.

1. Select the Quick Set to edit by clicking on the checkbox near the Quick Set name.
2. Tap the **Edit** icon. A window will open with information on the Quick Set.
3. Edit the information and follow the steps. Tap **OK** to finish.

Deleting a Quick Set

Quick Sets can be deleted from the Embedded Web Server.

 **NOTE:** Factory Quick Sets cannot be deleted.

1. Select the Quick Set you want to delete by clicking on the checkbox by the Quick Set's name.
2. Tap the **Delete** icon. A confirmation window will open.

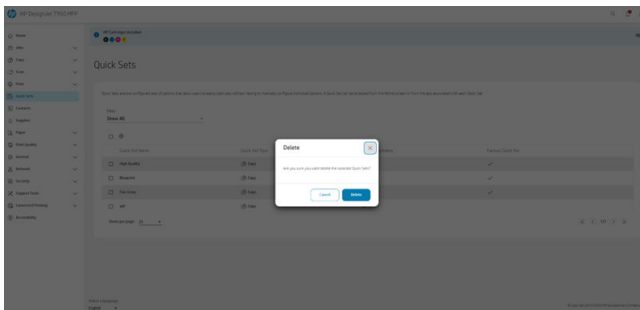

3. The Quick Set will be deleted. Tap **OK** to finish.

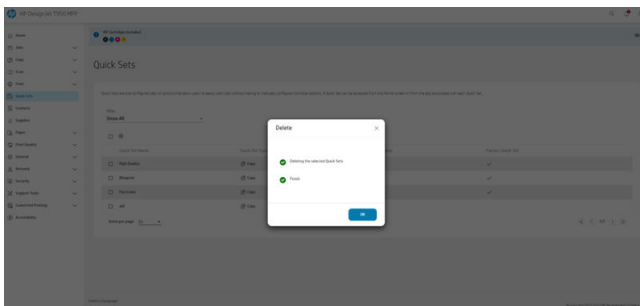

Copying a Quick Set

Quick Sets can be copied from the Embedded Web Server.

1. Select the Quick Set you want to copy by clicking on the checkbox by the Quick Set's name.

2. Tap the **Copy** icon. A window will open with information on the Quick Set.

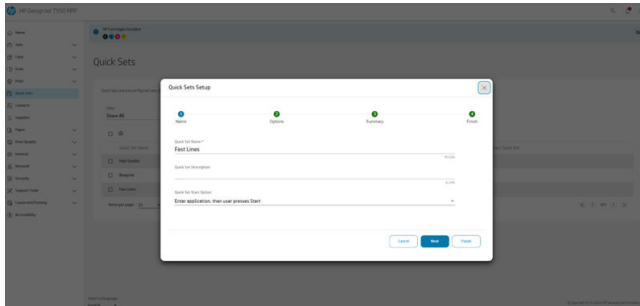

3. Give the Quick Set a new name, add a description, and make any other changes to settings.
4. Follow the steps until you have saved the Quick Set. Tap **OK** to finish.
5. The duplicated Quick Set will now appear in the list.

Viewing a Quick Set

Quick Sets can be viewed from the Embedded Web Server.

 **NOTE:** Only factory Quick Sets can be viewed.

1. Select the Quick Set you want to view by clicking on the checkbox by the Quick Set's name.
2. Tap the **View** icon. A window will open with information on the Quick Set.
3. Check any information you want to check and follow the steps. Tap **OK** to finish.

Launching Quick Sets

Quick Sets can be launched from the Embedded Web Server.

1. From the control panel, tap on the **Scan** or **Copy** menu.

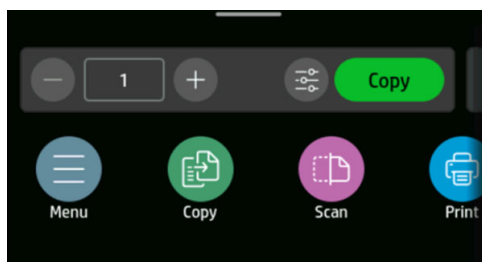

2. Select an appropriate Quick Set for your copy or scan job. Quick Sets can be temporarily modified by changing a setting.

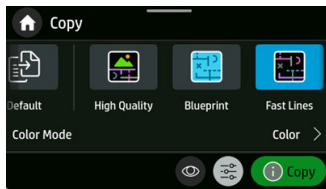

 **NOTE:** Created Quick Sets will appear here along with factory Quick Sets.

3. Click on **Copy** or **Send** to start the process.
4. Follow the instructions on the control panel to finish.

9 Practical printing examples

Step by step examples to print drafts, projects, presentations etc. to help you follow correct procedure with your jobs.

Print a draft for revision with the correct scale

Page size and orientation may not always be set as you require. This can be altered.

Using Adobe Acrobat

Print a revision draft with the correct scale.

1. In the Acrobat window, bring the mouse cursor to the bottom left corner of the document pane to check the page size.

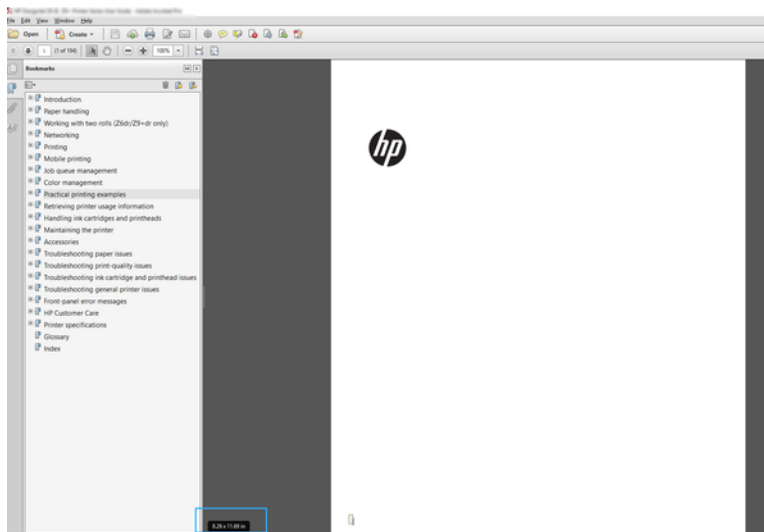

2. Select **File > Print** and ensure that **Page Sizing & Handling** is set to **Actual size**.



NOTE: The page size will **not** be automatically selected according to the drawing size.

3. Click the **Properties** button.
4. Choose whatever **Document Size** and **Print Quality** you want to use. If you want to define a new custom paper size, follow the instructions in [Custom paper sizes on page 39](#).
5. Select **Rotation**, then **Autorotate**.
6. Click **OK**, and check that the print preview in the **Print** dialog box seems correct.

Print a PDF multipage job from Adobe Acrobat Reader or Adobe Acrobat Pro

Set up for a multipage job is a quick and simple process.

You can print a multipage job from Adobe Acrobat.

1. Open a multipage job in Adobe Acrobat Reader or Adobe Acrobat Pro (HP recommends always using the latest version).
2. Click **File > Print**.
3. Select the printer and driver.
4. Check the **Choose paper source by PDF page size** box.

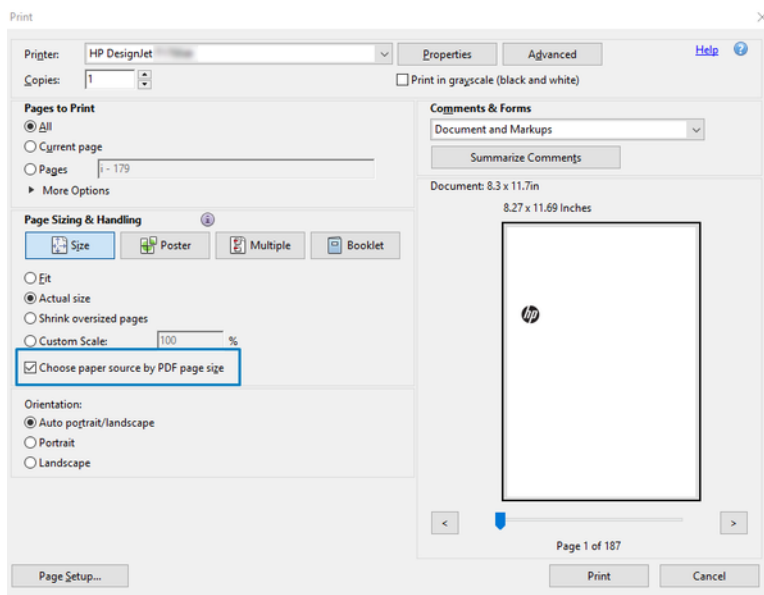

5. Adjust other properties in the driver properties window, as required.
6. Click the **Print** button.

Print a document with the correct colors

Print a document from Adobe Acrobat and Adobe Photoshop, with the emphasis on color management.

Using Adobe Acrobat Reader

The print process is very simple. Acrobat Reader is the most basic application for PDF files; several color management tools common in more sophisticated applications are not explicitly present, and work by default with presets that cannot be changed.

For example, there is no way to select a working color space; a default color space, most likely sRGB, is applied. This color space is used for screen display, for example. Also, as an alternative color profile when no other is specified by a file, as will be explained later.

1. Click **File > Print**.

2. Select the printer and driver from the **Printer** drop-down menu in the **Print** dialog box. Driver settings can be adjusted by clicking the **Properties** button.

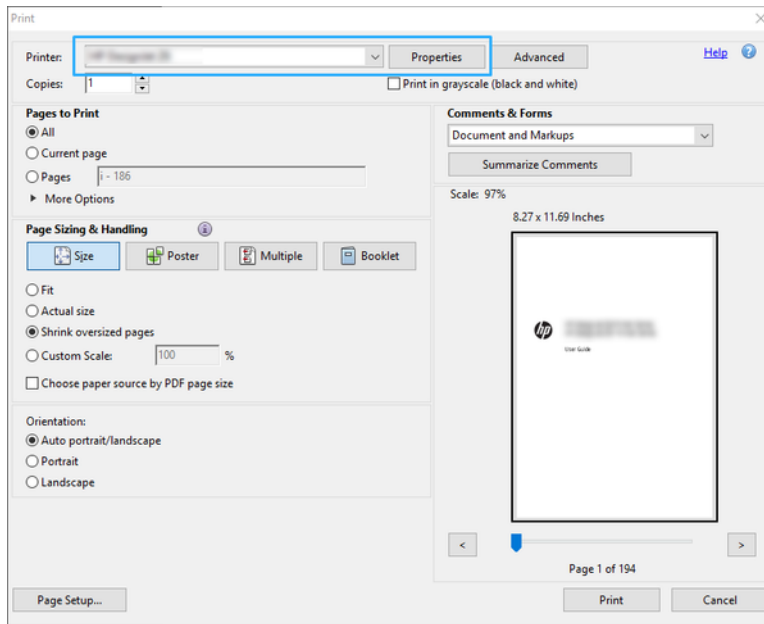

3. Adjust the color settings in the driver properties window. Click the **Properties** button in the **Print** dialog and set the **Color** option in the **Color mode** section. Click **OK**.
4. Click the **Advanced** button in the Print dialog box to set color management options. Check the box **Let printer determine colors**.

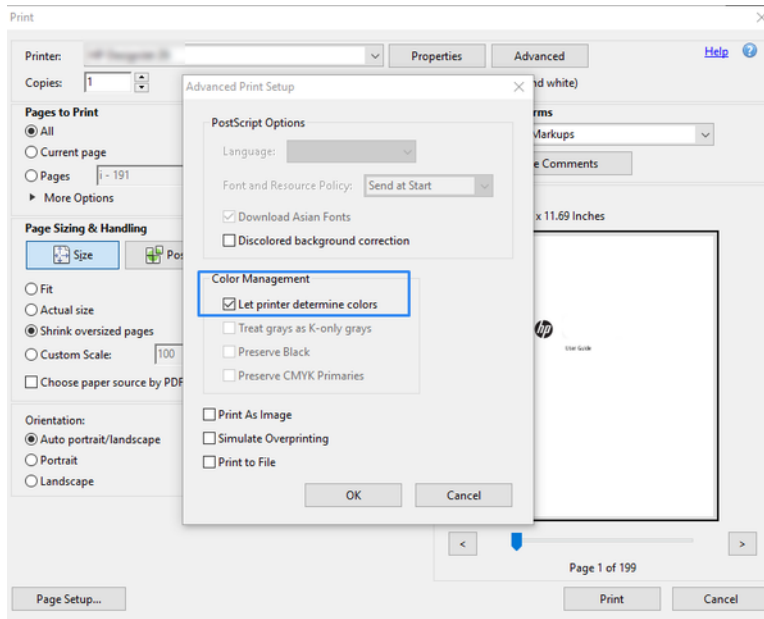

5. If the document contains several color profiles and you are not sure what the result will be, you can flatten the document first and print it as seen on the screen. To do this, check the box **Print As Image** in the Advanced Print Setup dialog box. In this case, the rasterization is performed by Acrobat Reader before calling the driver; whereas, if you do not check this box, the rasterization is

performed by the driver. So checking the box may have a visible effect on the look of the printed document.

Using Adobe Acrobat Pro

This is a professional application that allows full color management. See briefly described, the options to select a working color space, convert images to a desired color space, and print.

1. PDF files may not contain a color profile. In the absence of a color profile, Acrobat uses a working color space by default. To choose a working color space, first click **Edit > Preferences**.

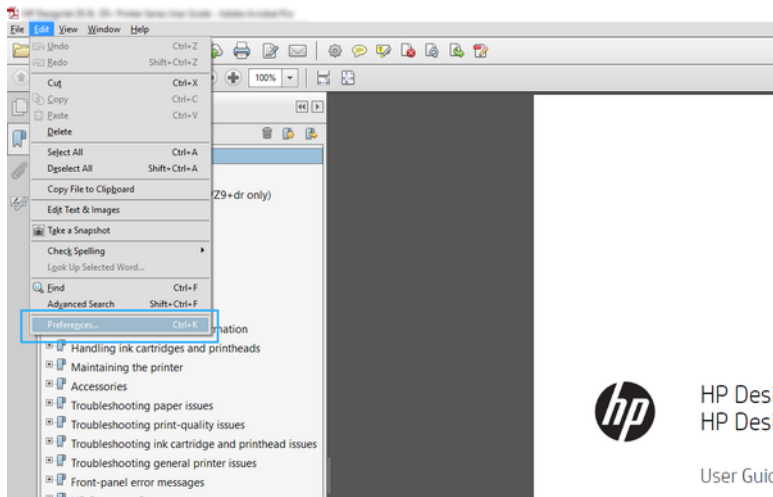

2. In the Preferences dialog box, you can choose RGB, CMYK, and grayscale working color spaces.

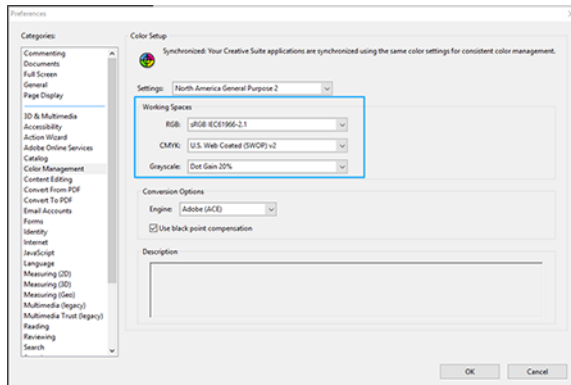

3. PDF files can contain elements with different color profiles. Some may have color profiles, some may not. The working color space will affect only those without a color profile. If you want to attach a specific color profile to the document, you must convert the contents of the document as follows.

First, select **Convert Colors** from **View > Tools > Print Production** or by clicking the icon in the status bar.

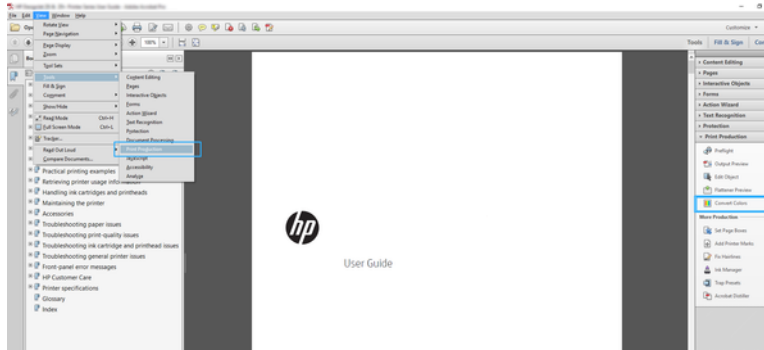

4. Select the elements you want to convert by specifying matching criteria (object type and/or color type) and then the conversion attributes. If you want to change the embedded color profile, you can select **Any Object** and **Any Colorspace** in the Matching Criteria section. In the Conversion Attributes section you can choose, for example, to embed an Adobe RGB (1998) profile by selecting it as the **Conversion Profile**, checking the **Embed** box, clicking the **OK** button, and saving the file to keep the changes. The saved file will have an embedded Adobe RGB color profile.

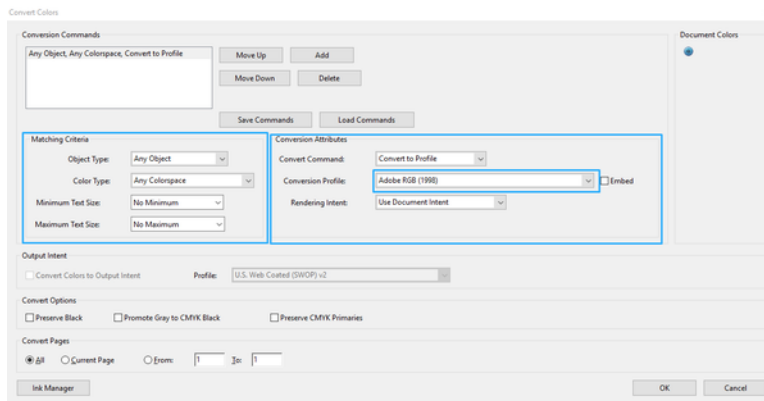

5. To print the document, choose a printer from the Print dialog box, click the **Properties** button, and in the **Color mode** section, set the color options.

 **IMPORTANT:** Select **Print in color** and **Printer managed colors**.

6. In the Print dialog box, click the **Print** button to print the document.

Using Adobe Photoshop

The printer can manage colors directly.

1. In Photoshop, click **File > Print**, then select your printer.

2. In the Color Management section, set the Color Handling option to **Printer Manages Colors**.

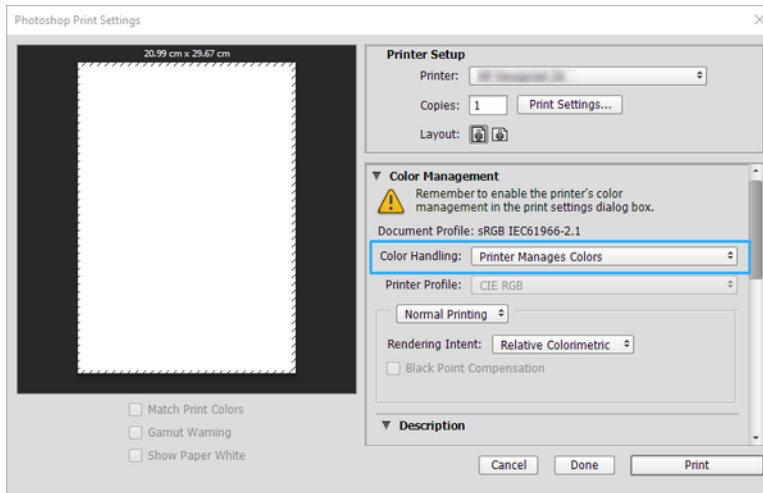

Print a project using Autodesk AutoCAD

Set up a plot to print from a model or a layout.

1. The AutoCAD window can show a model or layout. Normally a layout is printed rather than the model.

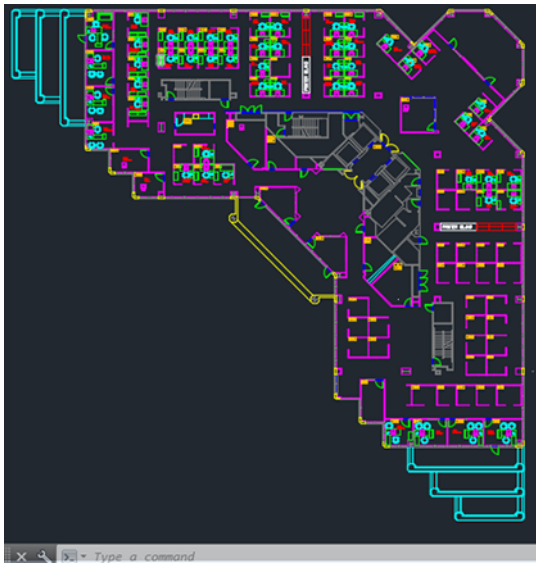

2. Click the **Plot** icon at the top of the window.

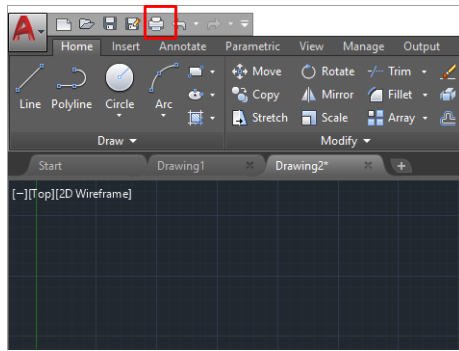

3. The **Plot** window opens.
4. You can see further options by clicking the circular button in the lower right corner of the window.

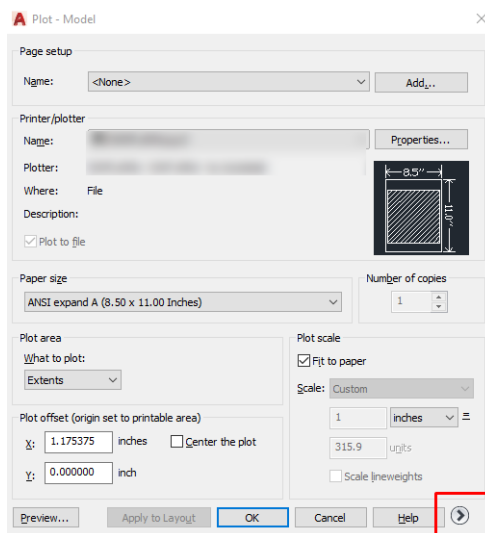

 **NOTE:** The Quality option here does not refer to the final print quality but to the quality of AutoCAD viewport objects that are sent for printing.

5. Select your printer and click the **Properties** button.

6. Select the **Device and Document Settings** tab, and click the **Custom Properties** button.

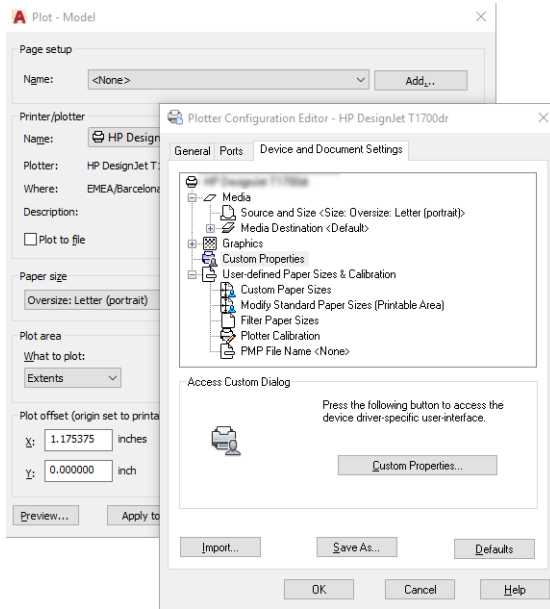

7. In the **Driver**, select the paper type that you intend to use.
8. Select the print quality.
9. If you intend to print on roll paper, you must decide where the printer should cut the paper.
 - With the Windows driver: Select **Document > Margin layout > Clip content by margins**.
10. Select the **Rotation** option **Autorotate**. Autorotation can help to avoid wasting paper.
11. Click the **OK** button and save your configuration changes to a PC3 file.
12. When you have clicked the **OK** button in the Plot window, the printer will construct a print preview.

Print a presentation

Setup AutoCAD or Photoshop presentations.

Using Autodesk AutoCAD

Print a presentation with Autodesk AutoCAD.

1. Open the AutoCAD file and select a layout.

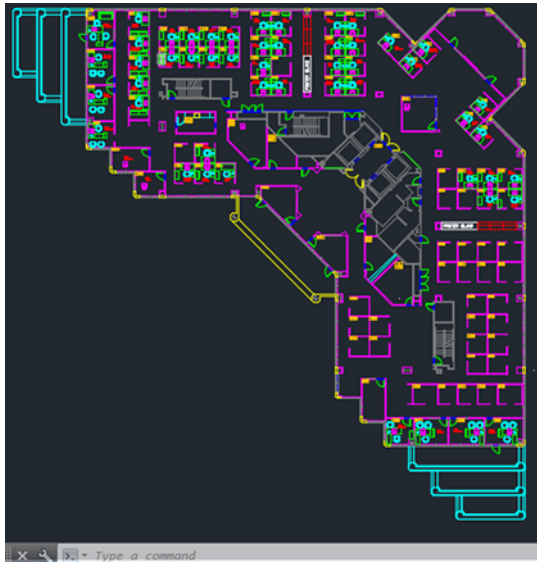

2. Click the Plot icon at the top of the window.

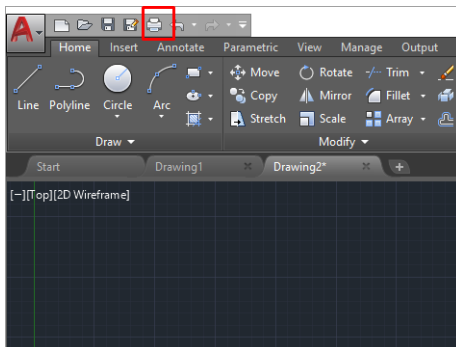

3. Ensure that the correct printer is selected, then click the **Properties** button.

4. Select the **Device and Document Settings** tab, and click the **Custom Properties** button.

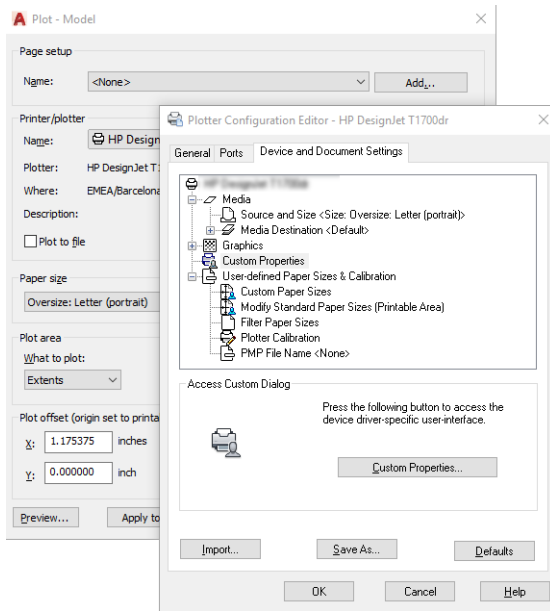

5. In the **Driver**, select the paper type that you intend to use.



NOTE: If you select neither the paper source nor the paper type, the printer will not print on any protected roll.

6. Select the print quality.
7. If you intend to print on roll paper, you must decide where the printer should cut the paper.
 - With the Windows driver: Select **Document > Margin layout > Clip content by margins**.
8. Select the **Rotation** option **Autorotate**. Autorotation can help to avoid wasting paper.
9. Click the **OK** button and save your configuration changes to a PC3 file.
10. When you have clicked the **OK** button in the Plot window, the printer will construct a print preview.

Using Adobe Photoshop

Print a presentation with Adobe Photoshop.

1. In Photoshop, click **File > Print** and then select your printer.
2. Click **Print settings**, then select the **Document size** option.
3. Choose from the available paper sizes.

If you don't find your desired paper size, create it by following the instructions in [Custom paper sizes on page 39](#).

4. Select **Show preview before printing**. You may also wish to change the default paper source, paper type and print quality.
5. In the **Color** section, the default color management option is **Printer managed colors**, which is the correct option as you have already selected **Printer Manages Colors** in Photoshop.

10 Handling ink cartridges and printhead

There are four replaceable ink cartridges that supply the printhead. You can check status information, and easily change an ink cartridge when required.

About the ink cartridges

Ink cartridges store the ink and are connected to the printhead, which distributes the ink on the paper.

To purchase additional cartridges, see [Accessories on page 100](#).

 **CAUTION:** Observe precautions when handling ink cartridges because they are ESD-sensitive devices. Avoid touching pins, leads and circuitry.

 **NOTE:** This printer is intended to work only with cartridges that have a new or reused HP chip, and it uses dynamic security measures to block cartridges using a non-HP chip. Periodic firmware updates will maintain the effectiveness of these measures and block cartridges that previously worked. A reused HP chip enables the use of reused, remanufactured, and refilled cartridges. More on the HP website at the following link: <http://www.hp.com/learn/ds>.

Store supply usage data

The HP cartridge used with this printer contains a memory chip that assists in the operation of the printer.

The HP cartridge used with this printer contains a memory chip that assists in the operation of the printer.

The memory chip stores a limited set of anonymous information about the usage of the printer, which can include the following: the date when the cartridge was first installed, the date when the cartridge was last used, the number of pages printed using the cartridge, the page coverage, the printing modes used, any printing errors that may have occurred, and the printer model. This information helps HP to design future products to meet our customers' printing needs.

The information collected by the memory chip does not include information that could be used to identify a customer or user of the cartridge or printer.

HP collects a sample of the memory chips from ink cartridges returned to HP's free return and recycling program (HP Planet Partners, see the HP website at the following link: <http://www.hp.com/recycle>). The sampled memory chips are read and studied in order to improve future HP products.

Any third party possessing the printer cartridge might have access to the information on the memory chip. If you prefer if you prefer to not allow access to this information, you can render the chip inoperable. However, after you render the memory chip inoperable, the memory chip cannot be used in an HP printer.

If you are concerned about providing this anonymous information, you can turn off the memory chip's ability to collect printer usage information. To do so, access the EWS and tap **Security > Security Settings**, then in the **Printer Settings** section, toggle to **Anonymous usage information**. This does not prevent the cartridge from working normally in other respects. However, if you change your mind later, you can restore the factory defaults to resume collecting printer usage information.

Check ink cartridge status

Information about the evolution of the ink cartridges.

To view the ink levels of your ink cartridges, tap the **Supplies** icon , then **Ink Cartridges** on the control panel. For more information, tap the specific cartridge.

In the Embedded Web Server go to **Home > Estimated Cartridges Levels** or **Supplies > Cartridges**.

For an explanation of the ink cartridge status messages, see [Ink cartridge status messages on page 157](#).

Replace an ink cartridge

There are two occasions when you need to replace an ink cartridge.

- The ink cartridge is very low and you want to replace it with a full cartridge for unattended printing (you can use up the remaining ink in the first cartridge at a more convenient time).
- The ink cartridge is empty or faulty, and you must replace it to continue printing.

⚠ **CAUTION:** Do not try to remove an ink cartridge while printing.

⚠ **CAUTION:** Remove an ink cartridge only if you are ready to insert another one.

1. Make sure the printer is turned on.
2. Open the ink cartridge cover on the rear right-hand side of the printer.

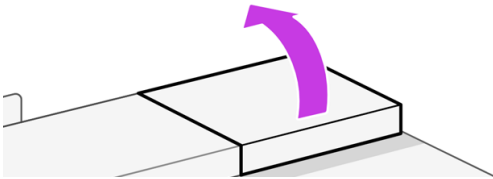

3. Remove the ink cartridge.

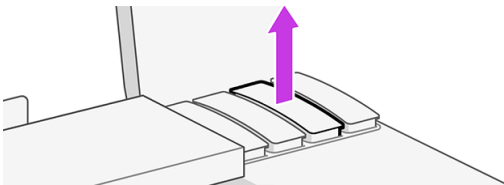

4. Insert the new ink cartridge. Make sure that you insert the ink cartridge into the slot that has the same colored letter as the cartridge you are installing.

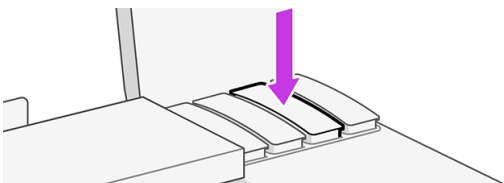

5. Close the ink cartridge cover.

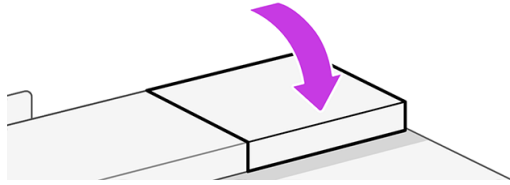

About the printhead

The printhead, which is supplied installed in the printer, is connected to the ink cartridges and jets ink onto the paper.

-
- ⚠ CAUTION:** Observe precautions when handling the printhead, because it is an ESD-sensitive device. Avoid touching pins, leads, and circuitry.
-

For information on replacing printheads, see [Replace the printhead on page 90](#).

Safe mode

Under certain conditions, including printer operation outside of environmental specifications, and when a used, refilled, or counterfeit ink cartridge has been detected, the printer will operate in safe mode.

HP is unable to warrant the performance of the printing system when operated outside of environmental specifications or when a used, refilled, or counterfeit ink cartridge is installed. Safe mode is designed to protect the printer and the printheads from damage due to unexpected conditions, and is in operation when the icon is displayed on the printer's control panel and by the Embedded Web.

For optimal performance, use original HP ink cartridges. HP DesignJet printing systems, including original HP inks and printheads, are designed and engineered together to provide uncompromising print quality, consistency, performance, durability, and value—with every print.

-
- 📝 NOTE:** This printer is not designed to use continuous ink systems. To resume printing, remove the continuous ink system and install genuine HP (or compatible) cartridges.
- 📝 NOTE:** This printer is designed for ink cartridges to be used until they are empty. Refilling cartridges prior to depletion might cause your printer to fail. If this happens, insert a new cartridge (either genuine HP or compatible) to continue printing.
- 📝 NOTE:** This printer is intended to work only with cartridges that have a new or reused HP chip, and it uses dynamic security measures to block cartridges using a non-HP chip. Periodic firmware updates will maintain the effectiveness of these measures. More on the HP website at the following link: <http://www.hp.com/learn/ds>.
-

11 Maintaining the printer

Checking printer status and maintenance are essential to keep your equipment in prime condition. Keep your printer clean, diagnose issues, calibrate, replace the printhead when required, and keep your software up to date.

Check printer status

There are various ways you can check the current printer status.

1. From the control panel, you can get information about the loaded paper and the ink levels.
2. If you access the Embedded Web Server, you see information about the general status of the printer.

Take care of the printer

The printer is not designed for any purpose other than printing.

It is not recommended to use the printer as a table, for two reasons:

- The surface can easily be damaged.
- Anything that falls into the printer can cause more serious damage.

Clean the exterior of the printer

Clean the outside of the printer and all other parts of the printer that you regularly touch as part of normal operation with a soft cloth and a mild household cleaner such as non-abrasive liquid soap.

⚠ **WARNING!** To avoid an electric shock, make sure that the printer is turned off and unplugged before you clean it. Do not let water get inside the printer.

⚠ **CAUTION:** Do not use abrasive cleaners on the printer.



Print Quality Diagnostic Report

There are two test patterns designed to highlight printhead reliability problems.

To print the Print Quality Diagnostic Report

Check the performance of the printhead that is currently installed in your printer, and whether it suffers from clogging or alignment problems.

1. Use the same paper type that you were using when you detected a problem. The test patterns are easiest to evaluate on plain white paper.
2. Check that the selected paper type is the same as the paper type loaded into the printer. See [View information about the paper on page 35](#).

3. From the printer's control panel, tap the **Menu** icon , then **Tools**  > **Reports**  > **Status Reports** > **Print Quality Diagnostic Report**.

 **NOTE:** The report can also be requested from the Embedded Web Server.

Test pattern 1: If the lines are not straight and connected, align the printhead. See [Align the printhead on page 90](#).



Test pattern 2: If you see thin white lines across and of the colored blocks, clean the printhead. See [Clean the printhead on page 89](#).



Corrective actions

If you have an issue with the diagnostic page, there are steps you can take, depending on the problem.

1. If the lines in Test Pattern 1 are not straight and connected, align the printhead (see [Align the printhead on page 90](#)).
2. If any of the colored blocks in Test Pattern 2 show white lines, are faded or completely missing, clean the printhead (see [Clean the printhead on page 89](#)). Follow the control-panel prompts and perform all three levels of cleaning if necessary.
3. If the problem remains, clean the printhead again.
4. If the problem remains, replace the printhead (see [Replace the printhead on page 90](#)). If the printhead is still in warranty, contact HP Support (see [Contact HP Support on page 175](#)).

Clean the printhead

If your print is streaked or has incorrect or missing colors, the printhead may need to be cleaned.

There are three stages of cleaning (Express, Basic and Advance). Each stage lasts about two minutes, uses one sheet of paper, and uses an increasing amount of ink. After each stage, review the quality of the printed page. You should initiate the next phase of cleaning only if the print quality is poor.

If print quality still seems poor after you complete all stages of cleaning, try aligning the printhead.

 **NOTE:** Cleaning uses ink, so clean the printhead only when necessary.

 **NOTE:** Failing to turn off the printer correctly can cause print-quality problems.

Clean the printhead from the control panel

When your print quality seems poor, and you are next to the printer, this is a simple method to address the issue.

1. Make sure there is paper in the input tray or a roll loaded.
2. Go to the control panel and tap the **Menu** icon , then **Tools > Troubleshooting > Print Quality (only MFP) > Printhead Cleaning**.

Align the printhead



Precise printhead alignment is essential for good area fill, line quality, and sharp edges in graphical elements.

Your printer has an automatic printhead alignment process which runs whenever a printhead has been accessed or replaced. You may need to align the printhead after a paper jam or if you are experiencing print-quality problems.

 **IMPORTANT:** Load minimum A4 and letter size paper. Do not load them in landscape.

1. Load the paper you wish to use, see [Paper handling on page 26](#). You can use a roll or a cut sheet; plain white paper is recommended.

 **CAUTION:** Do not use transparent or semi-transparent paper to align the printhead.

2. Ensure that the window is closed, as a strong light source near the printer during printhead realignment can affect alignment.
3. From the control panel, tap the **Menu** icon , then **Tools  > Troubleshooting  > Print Quality (only MFP) > Printhead Alignment**.

 **NOTE:** Printhead alignment can also be started from the Embedded Web Server (**Print Quality > Tools > Printhead Alignment**).

4. If the loaded paper is satisfactory, the printer runs the realignment and prints a realignment pattern.
5. The process takes about five minutes. Wait until the control-panel display shows the process complete before using the printer.



If the printer cannot complete the printhead alignment successfully, you may be asked to clean the printhead and try again.

Replace the printhead

When the printhead has an issue that cannot be fixed, you must replace it. After replacement, the printer will automatically perform a printhead alignment on the loaded paper.

 **TIP:** If you would like to perform the printhead alignment on a different paper (perhaps from the tray), you could change the paper before starting this procedure. Plain white paper is recommended. A4 and letter paper should not be loaded in landscape orientation.

1. Make sure the printer is turned on.
2. Make sure the printer wheels are locked (the brake lever is pressed down) to prevent the printer from moving.

3. From the control panel, tap the **Menu** icon , then the **Supplies** icon , then **Printheads > Replace Printhead**. Follow the instructions on the control panel.
4. Open the main door.

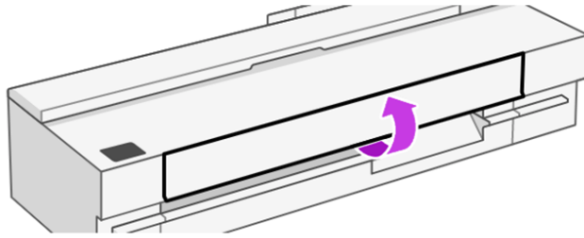

5. Open the printhead door on the right-hand side of the printer.

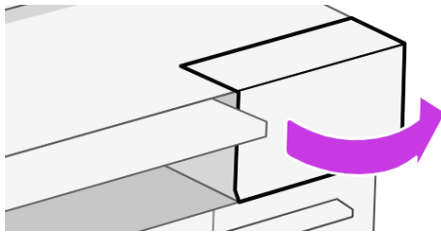

6. Locate the tubes connector-lever to release the ink tubes.

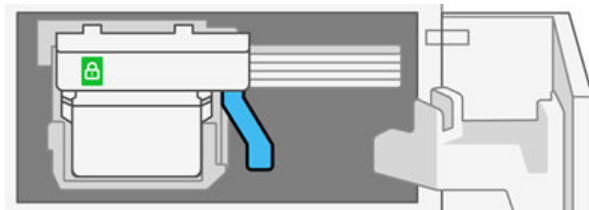

7. Raise the lever to release the tube connector and store the tubes connector on the tubes connector-holder in the printer door.

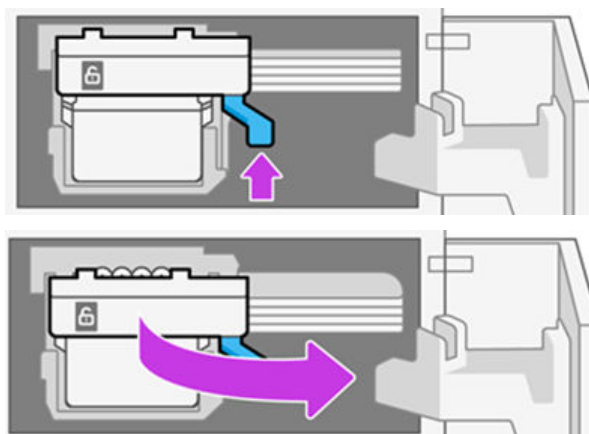

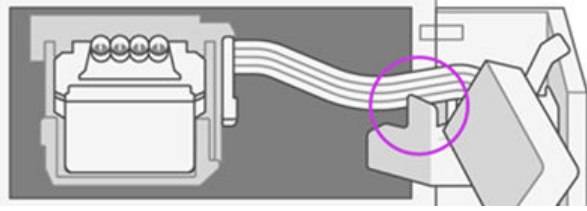

8. Locate the printhead lever.

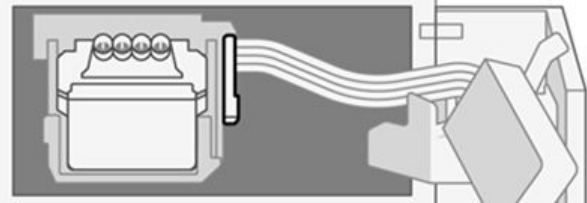

9. Raise the lever to release the printhead.

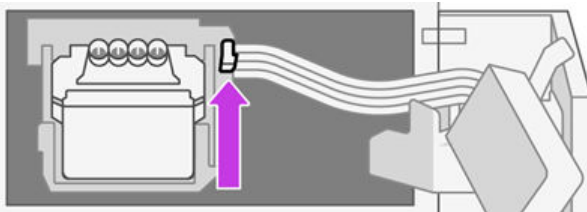

10. Remove the printhead, handling it with care to avoid getting ink on the connections.

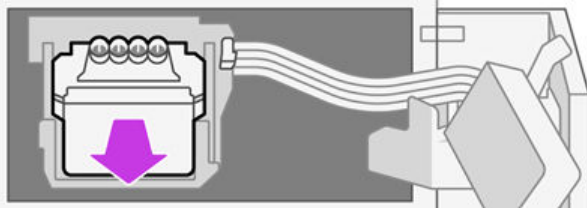

11. Insert the new printhead.

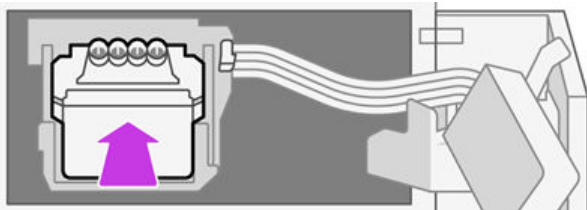

12. Lower the printhead lever (white).

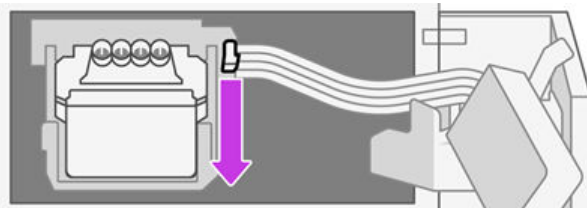

13. Insert the tubes connector into the printhead.

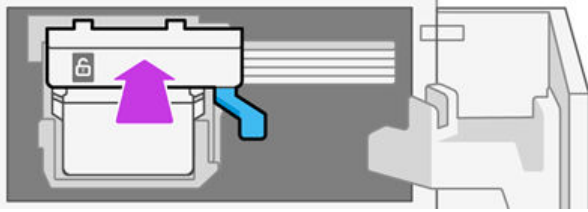

14. Make sure that the tubes connector locks shut.

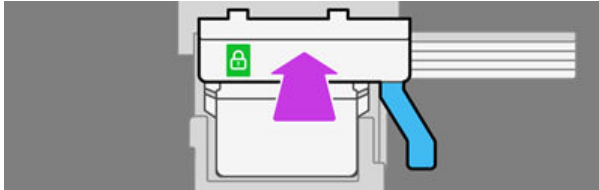

15. Close the printhead door.

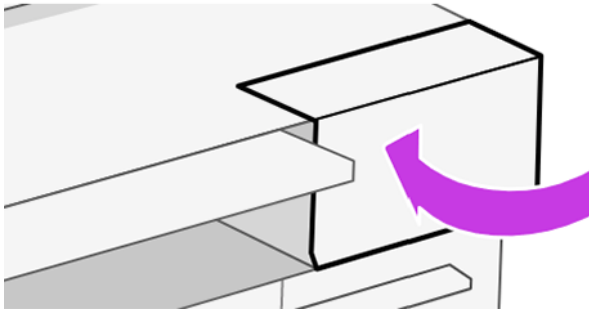

16. Close the main door and follow the instructions on the control panel.

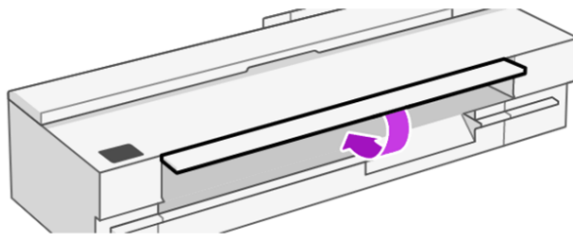

The control panel now recommends a printhead alignment.

The printer prepares the printhead for use.

 **NOTE:** Do not open any covers during this process.

Cannot connect the tubes to the printhead

It is important that you are using the correct type of printhead, and that it is well placed in its slot.

1. Check that the printhead is correctly inserted. See [Cannot insert the printhead on page 157](#).

2. Check that the tubes connector lever (blue) is up before connecting the tubes connector.

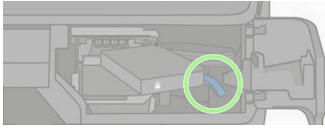

Clean the encoder strip

You can use a small damp cloth to remove unwanted residue.

1. Turn off the printer: Press the power key and unplug the power cable.
2. Using tap water and a small cloth that will not leave fibers in the printer, dampen the cloth and remove any excess water, so that the cloth is damp but not wet.
3. Open the main door.
4. Hold the cloth in an inverted U shape around the encoder strip and carefully wipe until no further ink residue appears on the cloth. Be very careful not to scratch the encoder strip with your fingernails or any other object. Make sure that you are holding the cloth correctly.



NOTE: Do not move the carriage away from the service station.

5. Close the main door.
6. Turn the printer on.

Recalibrate the paper advance

Accurate paper advance is important to image quality because it is part of controlling the proper placement of dots on the paper. If the paper is not advanced the proper distance between printhead passes, light or dark bands appear in the print and image grain may increase.



The printer is calibrated to advance correctly with all the papers appearing in the control panel. When you select the type of loaded paper, the printer adjusts the rate at which to advance the paper while printing. However, if you are not satisfied with the default calibration of your paper, you may need to recalibrate the rate at which the paper advances. See [Troubleshooting print-quality issues on page 121](#) to determine whether paper advance calibration will solve your issue.

Recalibrating the paper advance procedure

The recalibration procedure takes approximately three minutes.



TIP: It is recommended to only have the paper loaded that you want to calibrate.

1. From the control panel, tap the **Menu** icon , then **Tools**  > **Troubleshooting**  > **Print Quality** (only MFP) > **Automatic Paper-Advance Calibration** > **Paper-Advance Calibration**. When prompted by the control panel, confirm the paper source and type. The printer automatically recalibrates the paper advance and prints a paper advance calibration image.
2. Wait until the control panel displays the status screen and re-print your print.



NOTE: Do not worry about the paper advance calibration image.

If you are satisfied with your print, continue using this calibration for your paper type. If you see improvement in your print, continue with the next step. If you are dissatisfied with the recalibration, return to the default calibration, see [Return to default calibration on page 95](#).

3. If you would like to fine tune the calibration, or are using a transparent paper, tap the **Menu** icon ☰ from the control panel, then tap **Tools** 🛠️ > **Troubleshooting** ⚙️ > **Print Quality (only MFP)** > **Paper-Advance Calibration** > **Manual Paper-Advance Calibration**.
4. Select the percentage of change from -99% to +99%. To correct light banding decrease the percentage. To correct dark banding increase the percentage.
5. To save the value, tap **OK** on the control panel.
6. Wait until the control panel displays the status screen and reprint your print.

Return to default calibration

This sets all the corrections made by the paper advance calibration to zero. To return to the default paper advance calibration value, you must reset the calibration.

1. From the control panel, tap the **Menu** icon ☰, then **Tools** 🛠️ > **Troubleshooting** ⚙️ > **Print Quality (only MFP)** > (...) > **Reset Calibrations**.
2. Wait until the control panel displays the operation has completed successfully.

Clean the scanner scanbars

You are recommended to clean the scanbars periodically, depending on how often you use the scanner.

1. Turn off the printer using the power key, turn off the power switch and disconnect the power cable.

 **IMPORTANT:** Make sure to turn off the printer before cleaning. It is important to allow the printer to restart after cleaning to solve any issues.

2. There are two small indented buttons at the front of the scanner. Press them to open the scanner cover.

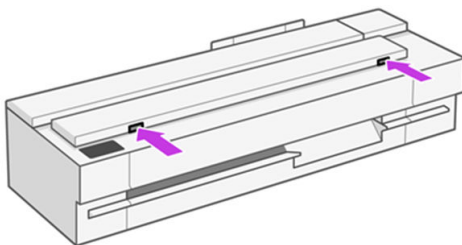

 **WARNING!** Be careful while the scanner lid is open. Your fingers or hand may be trapped or crushed.

3. Lift the scanner cover.

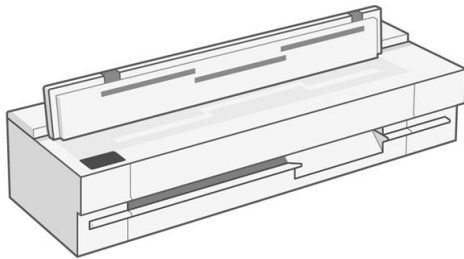
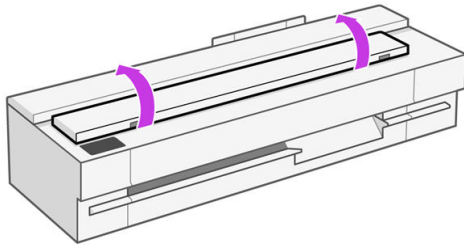

4. Clean the scanner scanbars and the surrounding area with a lint-free cloth.

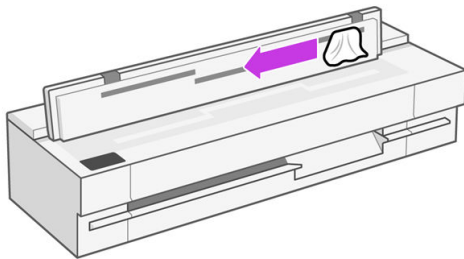

5. For more thorough cleaning, clean the calibration surfaces and the feed rollers.

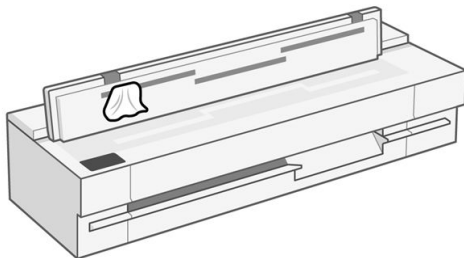

6. Close the scanner cover and gently push it down to lock it into place.

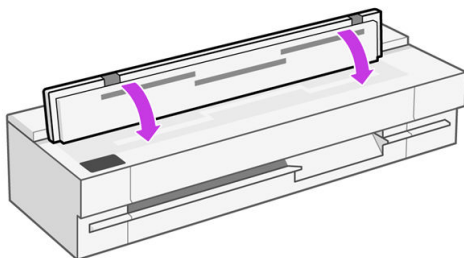

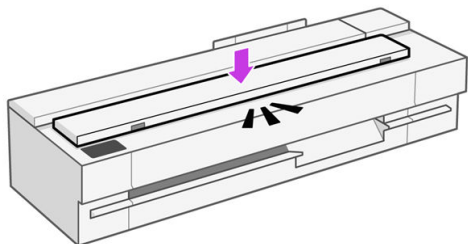

7. Clean the area immediately in front of the scanner, where the scanned sheet rests before scanning.
8. Reconnect the printer's power cable, turn on the power switch at the rear, and turn on the printer using the power key.

Calibrate the scanner

Your scanner has been calibrated at the factory, and theoretically CIS scanners do not need to be recalibrated during their lifetimes.

Nevertheless, because of environmental changes, your scanner may start showing image defects that can be easily corrected by recalibrating the scanner.

If you perform calibration successfully and still have concerns about the image quality, read [Troubleshooting copy and scan quality issues \(only MFP\) on page 134](#) to decide whether you are facing a product limitation, and may want to consider buying a CCD scanner.

To calibrate the scanner

The whole procedure takes less than 10 minutes, and you are recommended to recalibrate the scanner whenever you see some undesired artifact or a lack of quality in scanned files or copies, bearing in mind the limitations of CIS technology already explained in this guide.

1. Clean the scanner. See [Clean the scanner scanbars on page 95](#).
2. Go to the control panel, swipe down the dashboard and from the **Menu**, tap **Tools**, then **Troubleshooting, Scanner Calibration**, and then **Start** (it requests a 36" roll to print the calibration target if you need to print it).
3. Follow the instructions in the control panel.

If calibration fails

Ensure that the printer is turned on and ready for normal operation.

1. Ensure that the scanner is working correctly. To test it, scan a small document to file.
2. Ensure that the scanner is clean before calibration. If in doubt, clean the scanner and restart the calibration process.
3. Eject and reload the calibration sheet, checking that it is clean, in good condition, face up and perfectly centered in the scanner.
4. If the above steps do not help, eject the sheet and restart the printer (turn off and on). When the system has restarted, repeat the calibration.

5. If you cannot perform the calibration successfully in three consecutive attempts, call HP support and report the error code that appears in the control panel. See [Contact HP Support on page 175](#)

Move or store the printer

If you need to move the printer, take care to prepare it correctly to avoid possible damage.

To prepare the printer:

1. Do not remove the ink cartridges or printhead.
2. Make sure that no paper is loaded.
3. Turn off the printer using the **Power** key at the back.
4. Unplug the printer's power cord.
5. Disconnect any cables connecting the printer to a network or a computer.

 **CAUTION:** If you turn the printer upside down, ink could escape into the printer and cause serious damage.

When the printer is turned back on, it takes about three minutes to initialize itself and to check and prepare the printhead. Preparing the printhead normally takes just over a minute. However, if the printer has been off for a eight weeks or more, preparing the printhead could take up to a few minutes.

 **CAUTION:** If the printer remains off for a long period of time, the printhead may become unusable. In this case, you need to replace the printhead with a new one.

Firmware update

The printer's various functions are controlled by firmware that resides in the printer.

From time to time firmware updates will be available from HP. These updates improve the printer's functionality, enhance its features, and may correct minor problems.

 **IMPORTANT:** You are strongly recommended to update the firmware periodically in order to take advantage of the latest developments.

There are various ways of downloading and installing firmware updates; you can choose whichever you find most convenient. They can be divided into two categories: automatic and manual updates.

Automatic firmware updates

Automatic firmware updates are available for printers connected to the Internet.

Your printer can automatically download the latest firmware release and install it for you.

 **IMPORTANT:** Your printer must be connected to the Internet and the firmware update setting must be set to "Install updates automatically".

To configure automatic firmware updates:

- From the control panel: **Menu > Settings > Firmware Update.**

- From the EWS: **General > Firmware Update > Firmware update**.

Once the printer detects that there is a new firmware available, follow the instructions on the control panel.

Manual firmware updates (only MFP)

Manual firmware updates can be carried out using a USB flash drive.

1. Download the firmware file from the HP website. See [Software update on page 99](#).
2. Copy the file into the USB flash drive and insert it into the Hi-Speed USB host port in the control panel.
3. Go to the control panel: **Menu > Tools > Maintenance > Firmware** and select **Update from USB**.
4. Select the downloaded firmware file and follow the instructions on the control panel.

Manual firmware updates (only non-MFP)

1. Download the software from the HP website. See [Software update on page 99](#).
2. Run the downloaded software on your computer and follow the instructions.

Software update

Manual updates of printer drivers and other software are available for your printer.

Go to the HP website at the following links:

- **HP DesignJet T850:** <https://www.hp.com/go/DesignJetT850/software>
- **HP DesignJet T850 MFP:** <https://www.hp.com/go/DesignJetT850MFP/software>
- **HP DesignJet T950:** <https://www.hp.com/go/DesignJetT950/software>
- **HP DesignJet T950 MFP:** <https://www.hp.com/go/DesignJetT950MFP/software>

Printer maintenance kits

Two maintenance kits are available for your printer, containing components that may need to be replaced after long use.

When one of them is needed, a message is displayed on the control panel and you should contact HP Support (see [Contact HP Support on page 175](#)) and request the maintenance kit. The kits are installed by service engineers only.

12 Accessories

Supplies and accessories can be ordered for your printer.

How to order supplies and accessories

There are two ways to order supplies or accessories for your printer.

- Visit the HP website at the following links: <https://hp.globalbmg.com/> and <https://www.hp.com/> on the Web.
- Contact HP Support (see [HP Support Center on page 173](#)).

The rest of this chapter lists the available supplies and accessories, and their part numbers.

Order ink supplies

Ink cartridges can be ordered singularly. There is also a printhead replacement kit you can order for your printer.

Table 12-1 Ink cartridges

Cartridge	Part number
HP 738 130ml Cyan DesignJet Ink Cartridge	498N5A
HP 738 130ml Magenta DesignJet Ink Cartridge	498N6A
HP 738 130ml Yellow DesignJet Ink Cartridge	498N7A
HP 738 130ml Black DesignJet Ink Cartridge	498N4A
HP 738B 130ml Black DesignJet Ink Cartridge	498P2A
HP 738 300ml Cyan DesignJet Ink Cartridge	676M6A
HP 738 300ml Magenta DesignJet Ink Cartridge	676M7A
HP 738 300ml Yellow DesignJet Ink Cartridge	676M8A
HP 738 300ml Black DesignJet Ink Cartridge	498N8A
HP 738B 300ml Black DesignJet Ink Cartridge	498P6A

Table 12-2 If you're using the DesignJet XT 950

Cartridge	Part number
HP 738M 300-ml Black DesignJet Ink Cartridge	498Q0A
HP 738M 300-ml Cyan DesignJet Ink Cartridge	676M9A
HP 738M 300-ml Magenta DesignJet Ink Cartridge	676N0A
HP 738M 300-ml Yellow DesignJet Ink Cartridge	676N1A

Table 12-3 Printhead

Printhead	Part number
HP 713 DesignJet Printhead Replacement Kit	498N0A

The availability of supplies varies by region. Check your local HP website for the availability of supplies in your region.

If you are using an XT printer version, or a printer bought in the Asia-Pacific region, please check the compatibility of supplies with a trusted reseller.

Order paper

HP printers can use a wide range of paper types.

To check the saltest information related to papers supported by your printer, go to the HP website at the following link: <http://www.hpmedia.com>.

Order accessories

Adding a second HP DesignJet Spindle will save you time loading and unloading rolls to a unique spindle. With the additional spindle, you have the next roll ready to load on your printer.

Table 12-4 Accessories

	Description		Strategic	Compatibility
HP DesignJet Sheet Organizer	Output pocket for tray sheets to be separated from LF pages.	698G7A	Yes	HP DesignJet T850, HP DesignJet T850 MFP
HP DesignJet Sheet Organizer & Stacker Kit	Combined output pocket for tray sheets and LF stacker.	698G8A	Yes	HP DesignJet T850, HP DesignJet T850 MFP
36-in Spindle T850	36-in Spindle for T850 (up to 150ft roll).	B3Q37A	No	HP DesignJet T850, HP DesignJet T850 MFP
36-in Spindle T950	36-in Spindle for T950 (up to 300ft roll)*.	7F2C8A	No	HP DesignJet T950, HP DesignJet T950 MFP
3-inch Core Adaptor	Accessory to load 3-inch rolls on a 2-inch spindle.	CN538A	No	HP DesignJet T950, HP DesignJet T950 MFP

Introduction to the accessories

You can increase your printer's possibilities with accessories.

Spindle

With extra spindles, you can quickly change from one paper type to another.

3-inch core

You can adjust the spindle's core to load 3-inch core paper rolls. Be aware that roll size cannot exceed the maximum diameter; HP DesignJet T950: 140 mm (5.5 in).

HP DesignJet Sheet Organizer: (HP DesignJet T850 Printer Series only)

You can collect A3 & sheet pages separately from large-format pages.

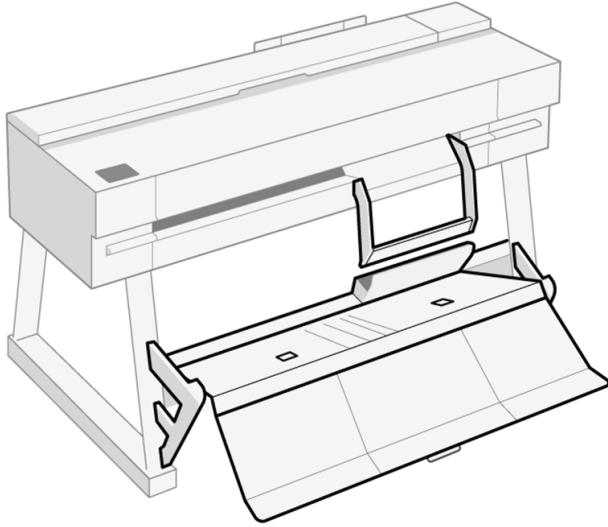

Please watch this how-to video on installing the Sheet Organizer for HP DesignJet T850 printers:
<https://www.hp.com/go/DesignJet%20T850/howto-video-sheetorganizer>.

Alternatively, you can scan the QR code to watch the video.

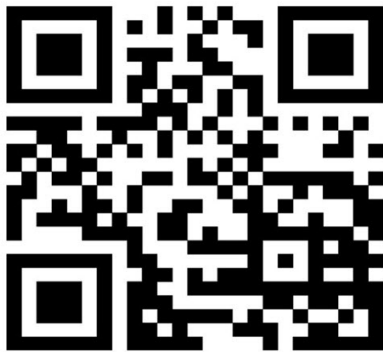

HP DesignJet Sheet Organizer & Stacker Kit: (HP DesignJet T850 Printer Series only)

You can modify media output management to have pages stacked, in order and separated by size.

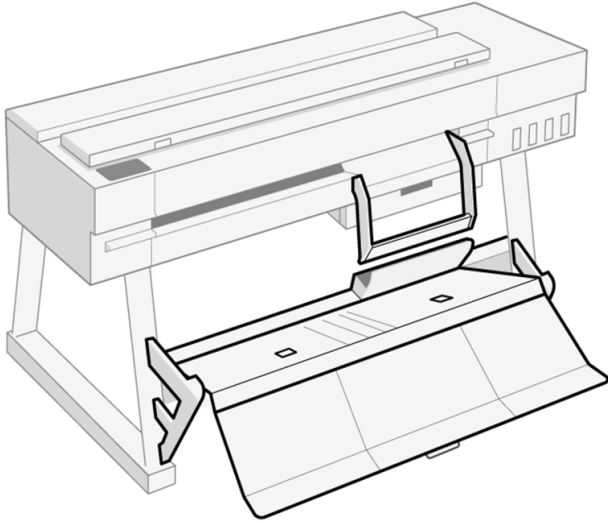

Please watch this how-to video on installing the Sheet Organizer and Stacker Kit for HP DesignJet T850 and HP DesignJet Smart Tank T918 MFP 36-in printers:
<https://www.hp.com/go/DesignJet%20T850-T918/howto-video-sheetorganizer-stackerkit>.

Alternatively, you can scan the QR code to watch the video.



13 Troubleshooting paper issues

When the printer detects a jam, it tries to resolve the issue automatically. If it cannot, it stops, and you must fix the problem manually.

Paper cannot be loaded successfully

There are various reasons why you may have issues loading the paper.

- Ensure that no paper is already loaded.
- Ensure that the paper is far enough inside the printer, you should feel the printer grab the paper.
- Do not attempt to straighten the paper during the aligning process, unless instructed to do so by the control-panel display. The printer automatically attempts to straighten the paper.
- The paper may be crumpled, or warped, or may have irregular edges.

Unsuccessful roll load

There are checks to make and steps to correct any problems.

- Check that the roll is at least 370 mm (14.5 in) wide: narrower rolls are not supported.
- Check the leading edge of the paper: if it is not straight or clean, it should be trimmed. Remove the initial 20 mm (1 in) from the roll and try again. This may be necessary even with a new roll of paper.
- Check that the roll ends are tight against the spindle ends.
- Check that the spindle is correctly inserted.
- Check that the paper is correctly loaded on the spindle, and that it loads over the roll towards you.
- Check that all roll tapes have been removed.
- Check that the paper is wound tightly on the roll.
- Do not touch the roll or paper at during the final steps of the loading process.

If the paper has not been inserted straight, follow the instructions on the control panel.

If you would like to start the load process again, cancel the process on the control panel and rewind the roll from the end of the spindle until the edge is removed from the printer.



NOTE: If the roll has become loose around the core, the printer cannot load the paper.

Unsuccessful sheet load

There are checks to make and steps to correct any problems.

- Check that the sheet is more than 210 mm (8.3 in) wide (A4/ANSI A).
- Guide the sheet, especially thick papers, when the printer initially feeds the sheet.

- Ensure that the sheet is aligned with the reference line on the roll cover.
- Do not attempt to straighten the sheet during the loading process, unless instructed to by the control-panel display.
- Do not use hand-cut sheets, which may be of irregular shapes. Use only purchased sheets.

In case of any problem, follow the instructions given on the control-panel display.

If you would like to start the load process again, cancel the process on the control panel; the printer ejects the sheet from the front of the printer.

Unsuccessful load from the tray (only HP DesignJet T850)

There are checks to make and steps to correct any problems.

- Check that you have not loaded too many sheets into the tray. The maximum number of sheets depends on the paper thickness: around 50 sheets of plain, standard paper.
- Check that the sheets are correctly loaded into the tray.
- Check that the sheets are correctly adjusted and centered in the tray.
- **HP DesignJet T850 36-in Printer only:** Check that you have extended the input tray correctly: the first extension for A4, the second for A3 paper.

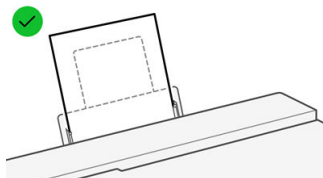
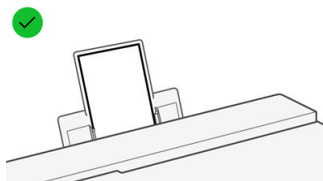

If the paper is hanging over the back of the input tray as shown, it may fail to load.

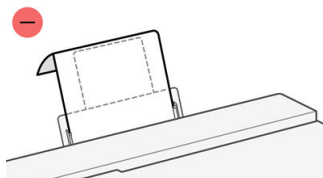



NOTE: Try to avoid leaving sheets of paper loaded in the printer for a significant length of time, because they will deform.

Paper loading error messages

There is a list of control-panel messages related to paper loading, with the suggested corrective action.

Table 13-1 Error Messages

Control-panel message	Suggested action
Paper loaded with too much skew	During the paper load process the printer detected that the paper had too much skew. Tap OK to unload the roll automatically, then restart the process.
Paper not detected	During the paper load process the printer did not detect any paper. Ensure the paper is inserted fully and is not transparent.
Paper too far from lateral edge	Reload the cut sheet, aligning the right edge against the black stop on the spindle.
Paper load failed. Paper width is smaller than the minimum size supported by the selected paper source.	Cut sheets smaller than ISO A4 must be loaded using the tray.
Sheet too big	During the load process the printer has detected that the sheet of paper is either too wide or too long to be loaded correctly. Tap the cancel icon  to stop the load process. See Functional specifications on page 176 .
Sheet too small	During the load process the printer detected that the sheet of paper is too narrow or too short to be loaded in the printer. Tap the cancel icon  to stop the load process. See Functional specifications on page 176 .

Paper type is not in the driver or control panel

To work with a paper type not present in the driver menu, you can identify the paper type as one of the presets already available in the driver, however, you must identify whether your paper is transparent or translucent, photo or bond, coated or technical.



NOTE: For glossy paper, it is important to select a glossy paper type, as the printer adjusts its use of ink for glossy paper.

Transparent or translucent film

You may use clear or matte film.

If your paper is a transparent film (for example, a transparency), select paper type **Film > Transparent/Clear film**.

If your paper is a translucent paper or film (for example, technical paper), select paper type **Film > Matte film**.

Photo paper

If your paper is a photo paper, use the **Photo Paper** category. For glossy or high-gloss paper select paper type **Photo Gloss Paper**. For Semi-gloss, Satin, Pearl, or Luster finishes, select paper type **Photo Semi-gloss/Satin Paper**.

Bond and coated or technical paper

Your paper type selection for generic paper depends on the paper's ink absorption capacity.

- For natural tracing papers, select paper type **Natural Tracing Paper < 65 g/m²** or **Natural Tracing Paper > 65 g/m²**, depending on the weight of the paper.
- For thin papers (< 90 g/m²) or uncoated papers (for example plain paper or bright white paper), select paper type **Bond and Coated Paper > Plain Paper**.

- For light coated papers (< 110 g/m²), select paper type **Bond and Coated Paper > Coated Paper**.
- For heavyweight coated papers (< 200 g/m²), select paper type **Bond and Coated Paper > Heavyweight Coated Paper**.
- For matte paper, select paper type **Polypropylene Matte** or **Adhesive Paper**. For a gloss or satin paper, select paper type **Adhesive Polypropylene Gloss**.

Black ink is easily removed when touched

This happens when your paper is incompatible with matte black ink.

To use an optimized ink combination, select paper type **Photo Paper > Photo Gloss Paper**.

After printing, the paper has wrinkles or there is too much ink

This happens when too much ink is used.

To use less ink, select a thinner category. Matte paper categories from thinnest to thickest are:

- Plain Paper
- Coated Paper
- Heavyweight Coated Paper

For other print-quality problems, see [Troubleshooting print-quality issues on page 121](#).

Paper size is not in the driver or control panel

Please note that some paper sizes may be identified by their standard ISO, ANSI, ARCH names rather than their actual dimensions.

For example, to support 12-in x 18-in media, please choose **ArchB** in the driver or control panel.

Printer printed on the wrong paper type

This happens when the printer prints your job before you were able to load your desired paper.

You may have **Use printer settings** selected for the **Paper Type** in the printer driver.

When **Use printer settings** is selected the printer will print immediately on whichever paper is loaded. Load your desired paper, see [Paper handling on page 26](#), and select your paper type specifically in the driver.

- **In the Windows driver dialog:** Select your paper type from the Paper Type list.
- **In the Mac OS X Print dialog:** Select the **Paper/Quality** panel, then from the **Paper Type** list, select your paper type.



NOTE: **Use printer settings** is the driver default.

Paper mismatch

If the paper currently loaded in the printer is not suitable for a particular job, the printer stops and waits for you to decide what to do. There are several ways in which the loaded paper may be considered unsuitable.

- The paper type is not as specified for the job.
- The paper source (roll, tray, or manual feed) is not as specified for the job.
- The paper size is smaller than specified for the job.

If you do not specify these things for a particular job, the printer will print on whatever paper is loaded.

If the printer stops for a paper mismatch, you can decide among the following alternatives:

- Load the correct paper and resume printing.
- Print the job on the already-loaded paper. The print may be clipped if the paper is not large enough.
- Cancel the job.

Cut-sheet doesn't enter or drops out of the sheet organizer

Ensure the correct paper-type settings are selected in the control panel in the tray tab. Ensure the paper guides in the tray are in the position that matches the paper size.

It is recommended to use long-grain orientation paper on a high ink volume document, as short-grain orientation paper has a tendency to curl and block the pocket's entrance, which causes documents to fall to the floor.

It is not recommended to use non-plain stiff paper as it can stop the paper from entering the sheet organizer, causing it to drop to the floor.

Roll has jammed

When a paper jam occurs, you normally see a message about it in the control-panel display.

1. Open the roll cover.

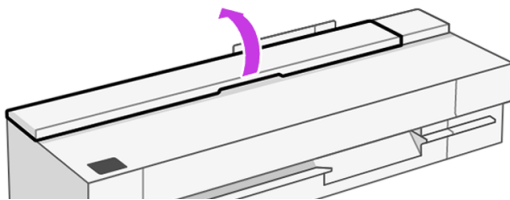

2. Open the main door.

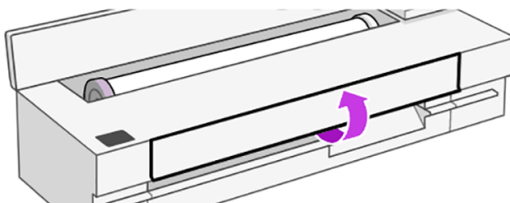

3. Rewind the roll to create a loop. Cut the paper, if needed.

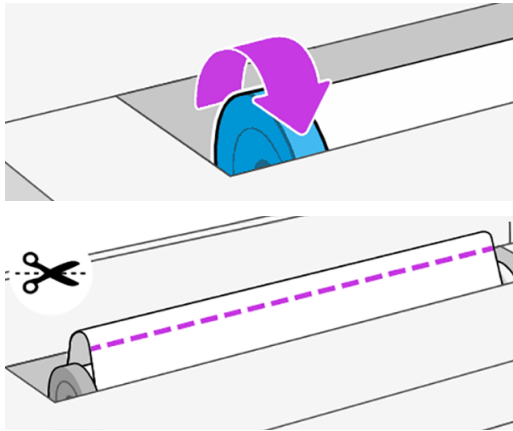

4. Carefully remove any of the jammed paper that you can from the top of the printer.

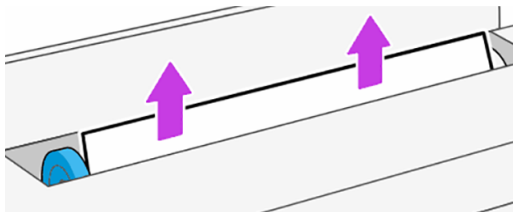

5. Carefully remove any of the jammed paper from the front window.

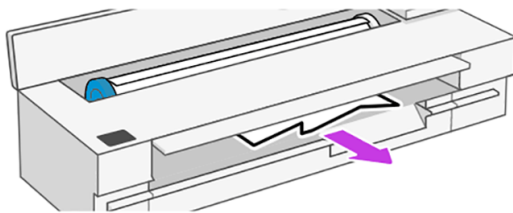

6. Reload the roll, or load a new sheet; see [Paper handling on page 26](#).

 **NOTE:** If you find that there is still some paper causing an obstruction within the printer, restart the procedure and carefully remove all pieces of paper. You may need to remove the tray (see [Tray has jammed \(only HP DesignJet T850\) on page 109](#) or [Tray has jammed \(HP DesignJet T950\) on page 110](#) depending on your model).

Tray has jammed (only HP DesignJet T850)

Paper can jam in the tray for a variety of reasons and there are steps to follow to correct an issue.

Proceed as follows:

1. Remove as much paper as you can from the tray.
2. Push down the tray extensions, which will make the tray easier to handle.

3. Unlock the tray, using the rotary switch behind it.

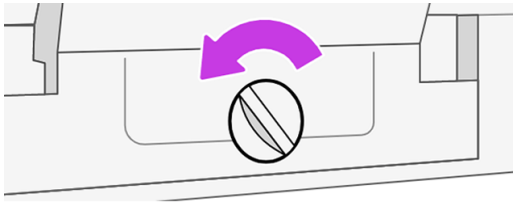

4. Pull out the tray.

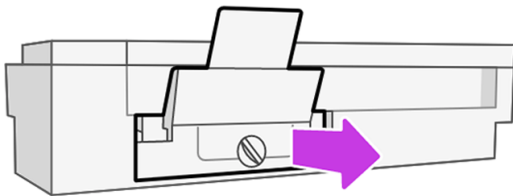

5. Remove all paper from the tray.

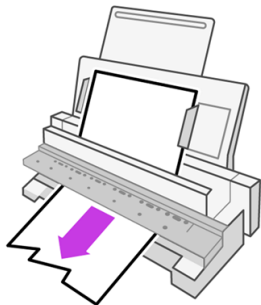

6. Put the tray in again.

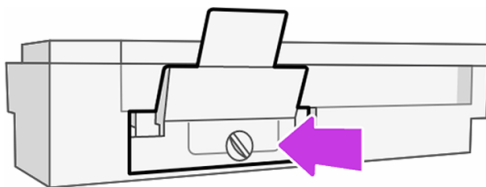

7. Lock the tray.

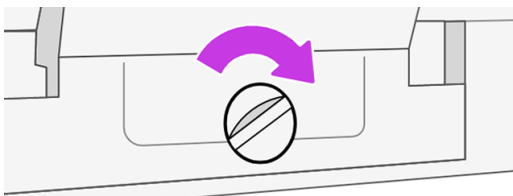

Tray has jammed (HP DesignJet T950)

Paper can jam in the tray for a variety of reasons and there are steps to follow to correct an issue.

Proceed as follows:

1. At the back of the printer, release the cleanout-tray cover by pushing the two buttons inwards.

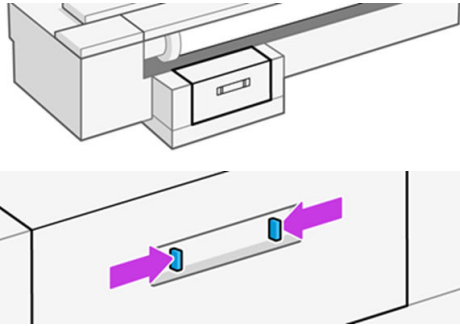

2. Remove the cleanout-tray cover.

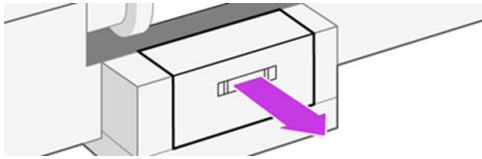

3. Remove all the paper.

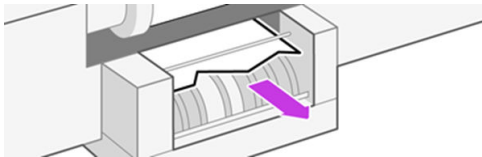

4. Put the cleanout-tray cover in again, and check it is locked into place.

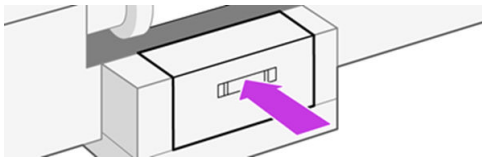

5. At the front of the printer, pull out the tray.

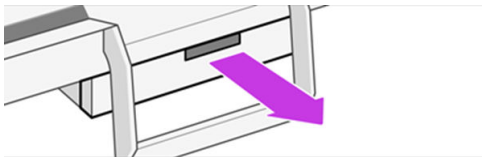

6. Remove all the paper from the tray.

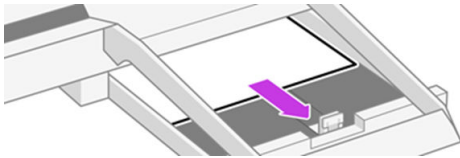

7. Put the tray in again.

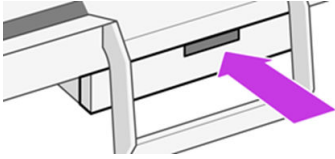

A single sheet has jammed

When a single sheet jam occurs, you normally see a message about it in the front-panel display.

 **NOTE:** Be sure to remove all paper pieces and fragments from the printer.

1. Open the top window.

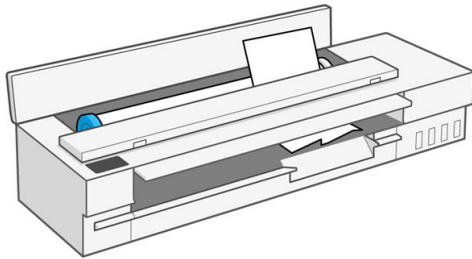
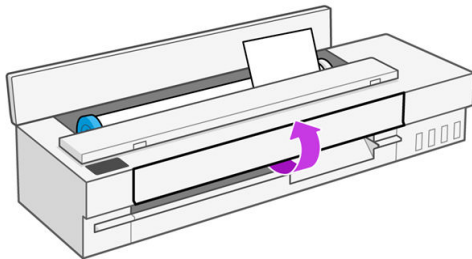

2. Remove the sheet from the printer.

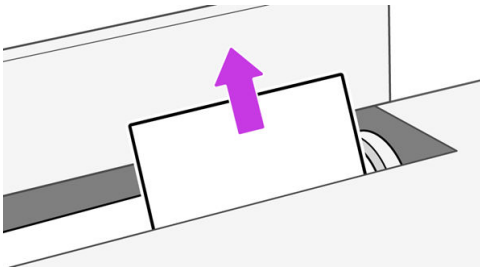

3. Remove any of the jammed paper.

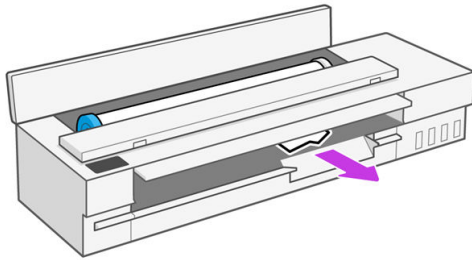

4. Close the top window when finished.

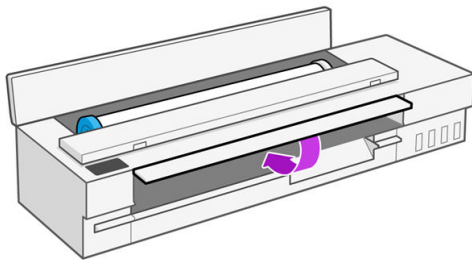

The paper has jammed in the scanner

The following steps provide the complete procedure for this topic.

When a paper jam occurs, a message about it appears in the front-panel display.

1. Open the scanner cover.

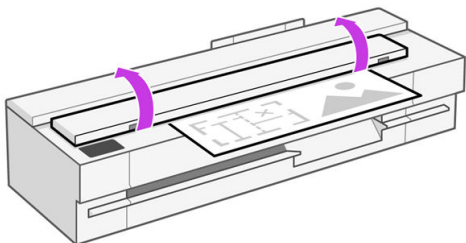
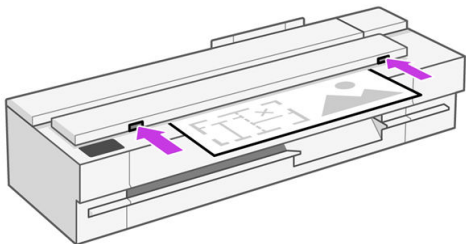

2. At the back, pull the media out from the top rear area.

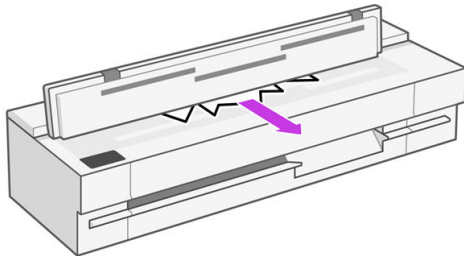
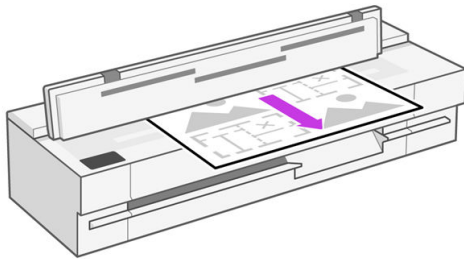
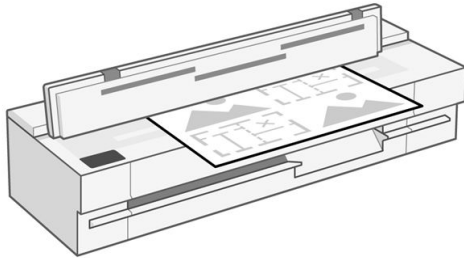

Or pull it from the front bottom area between the scanner platen and front window.

⚠ CAUTION: Do not move the paper sideways; it could damage the scanner!

Or pull it from the front bottom area between the scanner platen and front window.

3. Turn the rubber wheels with a finger in order to get better access to the paper, and remove any debris.
4. Close the scanner lid.

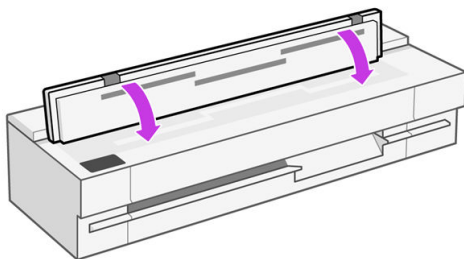

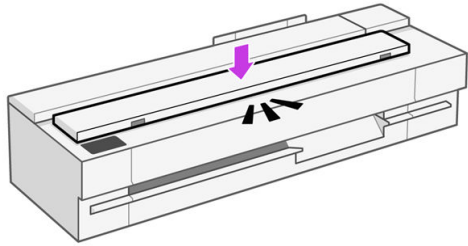

How to remove Paper Jams in HP DesignJet T850/T950 SF & MFP 36-in printers

<http://www.hp.com/go/DesignJetT850-T950/Jam-troubleshooting%22www.hp.com/go/DesignJetT850-T950/J>

A strip stays on the output area and generates jams

If a small piece of paper has been cut, such as before printing a new roll, or after the **Move and Cut** control panel option has been used, the cut strip may remain in the output area. Make sure that the printer is not printing, then reach into the area and remove the strip.

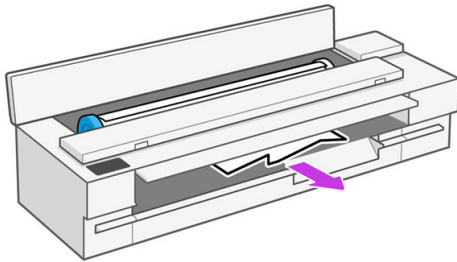

How to remove jams

This section explains how to remove jams from the HP DesignJet T850/T850 SF and MFP 36-in printers.

Please watch this how-to video on removing jams: <http://www.hp.com/go/DesignJetT850-T950/jam>.

Alternatively, you can scan the QR code to watch the video.



Printer displays out of paper when paper is available

If the roll has become loose from its core, it will not feed correctly and the printer will not load the paper. If possible, tighten the paper to its core or load a new roll.

Prints do not fall neatly into the bin

There are steps you can follow if there is an issue with the bin.

- Ensure the bin is correctly installed.
- Ensure the bin is open.
- Ensure the bin is not full.
- Paper often tends to curl near the end of a roll, which can cause output problems. Load a new roll, or remove prints manually as they are completed.

Change stacker from default to regular bin style configuration

Switching between the two configurations is a simple four-step process.

If the output is not stacked properly, you can try changing from default to regular bin style configuration. In this position, the stacker acts as a normal basket instead. The basket can accept up to 10 A1 or ANSI D-sized sheets of bond paper. Larger prints should be removed from the basket immediately after printing.

1. Close the stacker, moving both front and back boards in the down position.

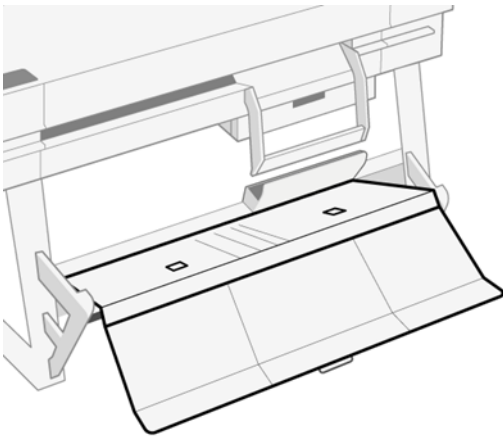

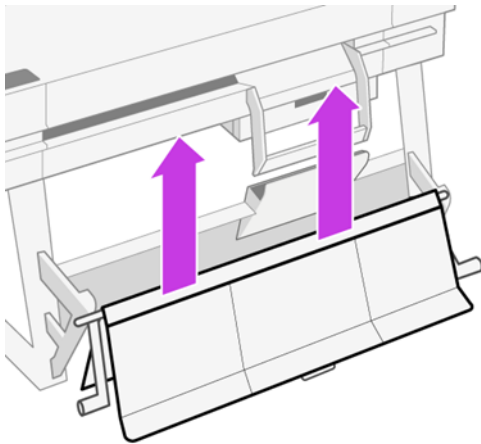
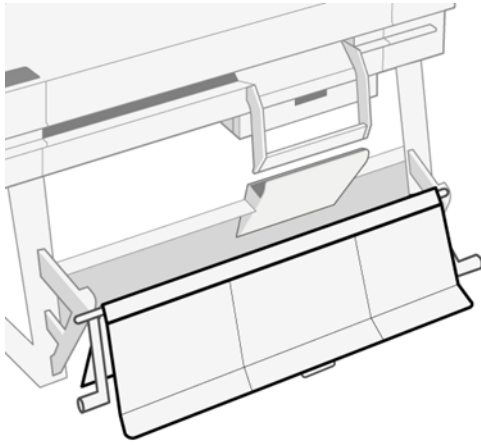
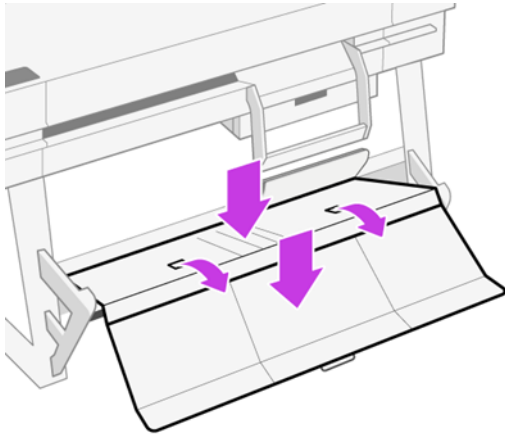

2. Lift and transfer the stacker to the lower slot position, ensure only the top pole is inserted onto the lower of the left and right semi circular slots.

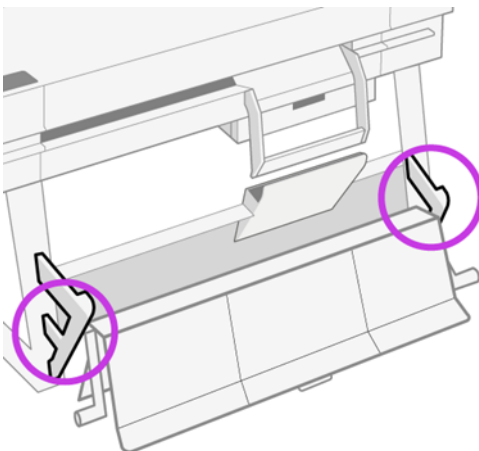
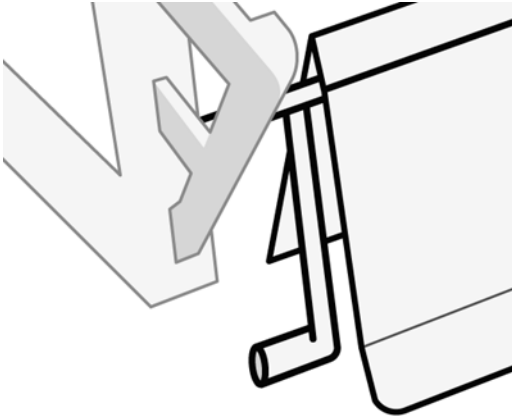
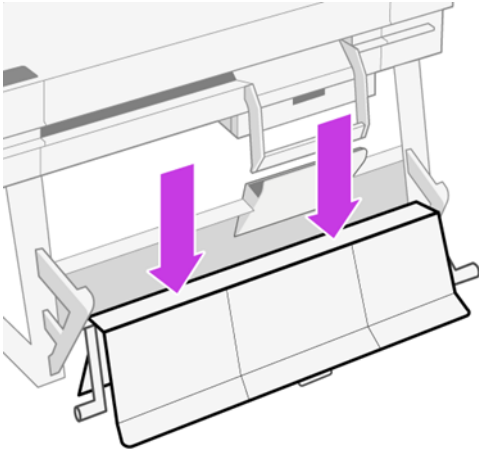

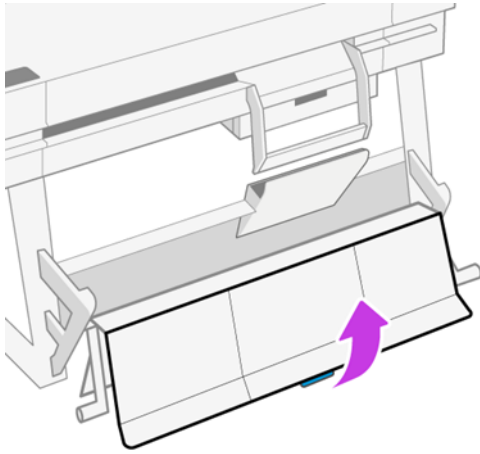

3. Lift the front board to the open position.

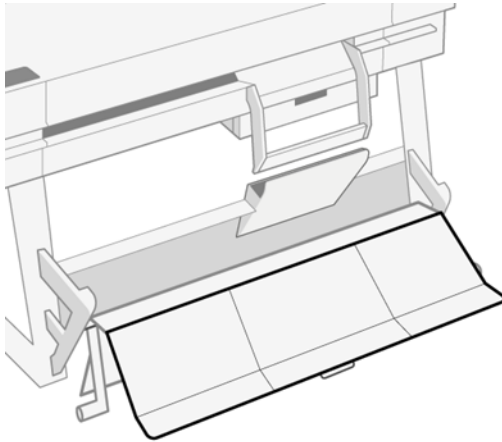

Sheet stays in the printer when the print has been completed

The printer holds the paper to allow the print to dry after printing.

See [Change the drying time on page 36](#). If the paper is only partially ejected after the drying time, gently pull the sheet out of the printer. If the automatic cutter is disabled, use the **Form feed and cut** option in the control panel, see [Advance button and cut button on page 37](#).

Paper is cut when the print has been completed

By default the printer cuts the paper after the drying time has been completed. You can disable the cutter.

See [Change the drying time on page 36](#). You can disable the cutter, see [Turn the automatic cutter on and off on page 36](#).

Cutter does not cut well

By default, the printer is set to cut the paper automatically after the drying time has been completed.

If the cutter is turned on but not cutting correctly, check that the cutter rail is clean and clear of any obstacles, and check that there are no pieces of paper in the cutter groove.

If using the driver, make sure that the cutter is not disabled in the print options.

Scanner does not load original

If you have difficulty loading, first check that the scanner is on, and then follow the steps in order to check and fix any issue.

1. Wait until the scanner has started up completely and is idle.
2. Check for messages on the front panel.
3. If you completed the above steps, check that the original meets the scanner specifications.
4. Make sure you are loading the original far enough into the scanner so that it can be detected.
5. Make sure the leading edge of the original is flat and the leading edge is even when loading it. If not, trim the leading edge so that the paper enters the scanner smoothly.
6. Try using a different paper type to exclude that the problem is caused by a scanner hardware issue.

Cannot connect the tubes to the printhead

It is important that you are using the correct type of printhead, and that it is well placed in its slot.

1. Check that the printhead is correctly inserted. See [Cannot insert the printhead on page 157](#).
2. Check that the tubes connector lever (blue) is up before connecting the tubes connector.

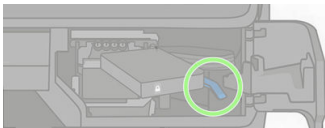

14 Troubleshooting print-quality issues

Step by step instructions are provided for you to identify and resolve your issue.

General printing advice

To achieve the best performance from your printer, use only genuine manufacturer's supplies and accessories.

- Genuine manufacturer's supplies and accessories have been thoroughly tested to give trouble-free performance and best-quality prints. For details of recommended papers, see [Order paper on page 101](#).
 - Make sure that the paper type selected in the control panel is the same as the paper type loaded into the printer (see [View information about the paper on page 35](#)). Also make sure that the paper type selected in your software is the same as the paper type loaded into the printer. See [Paper type is not in the driver or control panel on page 106](#) if you have doubts about the paper selection.
-
- ⚠ CAUTION:** If you have the wrong paper type selected, you could experience poor print quality and incorrect colors, and perhaps even damage to the printhead.
-
- Check that you are using the most appropriate print-quality settings for your purposes (see [Printing on page 38](#)). You are likely to see lower print quality if you have set the quality level to **Fast**.
 - Check that your environmental conditions (temperature, humidity) are in the recommended range. See [Environmental specifications on page 178](#).

Horizontal lines across the image (banding)

If your printed image suffers from added horizontal lines as shown (the color may vary).

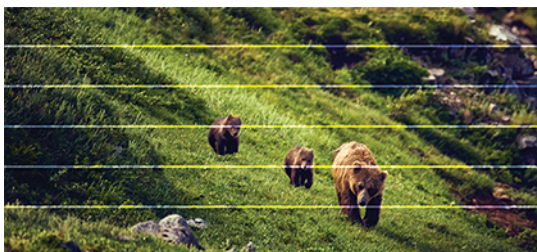

1. Check that the paper type you have loaded corresponds to the paper type selected in the control panel and in your software. If you have doubts about the paper selection, see [Paper type is not in the driver or control panel on page 106](#).
2. Check that you are using appropriate print-quality settings for your purposes (see [Printing on page 38](#)). In some cases, you can overcome a print-quality problem merely by selecting a higher print-quality level. For instance, if you have set the Print Quality level to **Fast**, try setting it to **Best**.
3. Print the Print Quality Diagnostic Report. See [To print the Print Quality Diagnostic Report on page 88](#).

4. If no issues were found in the Print Quality Diagnostic Report, but you still see white horizontal lines or white streaks in your image, clean the printhead, making sure you complete all phases of the cleaning process right until the end (see [Clean the printhead on page 89](#)).
5. If the printhead is working correctly, perform paper advance calibration: see [Recalibrate the paper advance on page 94](#).

If the problem persists despite all the above actions, contact your customer service representative for further support.

Lines are too thick, too thin, or missing

Check the paper type and settings, and run a report.

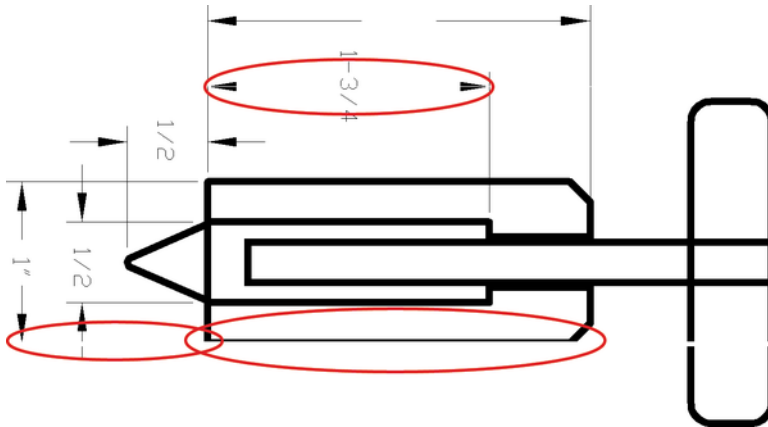

1. Check that the paper type you have loaded corresponds to the paper type selected in the control panel and in your software. If you have doubts about the paper selection, see [Paper type is not in the driver or control panel on page 106](#).
2. Check that you are using appropriate print-quality settings for your purposes (see [Printing on page 38](#)). If available for your paper, try turning on the **Maximum detail** option (under the **Print quality** setting).
3. If lines are too thin or missing, print the Print Quality Diagnostic Report. See [To print the Print Quality Diagnostic Report on page 88](#).
4. If the problem remains, perform a paper advance calibration: see [Recalibrate the paper advance on page 94](#).

If the problem persists despite all the above actions, contact your customer service representative for further support.

Lines appear stepped or jagged

Check your original image, and print-quality settings.



1. The problem may be inherent in the image. Try to improve the image with the application you are using to edit it.
2. Check that you are using appropriate print-quality settings. See [Printing on page 38](#).
3. Turn on the **Maximum detail** option (under the **Print quality** setting) only available for Photo paper.

Lines print double or in the wrong colors

This problem can have various visible symptoms.

- Colored lines are printed double, in different colors.

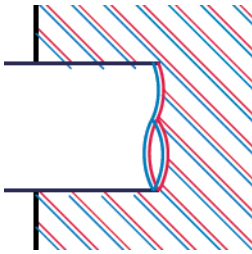

- The borders of colored blocks are wrongly colored.



To correct this kind of problem, print the Print Quality Diagnostic Report, and align the printhead if recommended in the report. See [To print the Print Quality Diagnostic Report on page 88](#).

Lines are discontinuous

Check your print-quality settings and print a Print Quality Diagnostic Report.



1. Check that you are using appropriate print-quality settings. See [Printing on page 38](#).
2. Print the Print Quality Diagnostic Report, and align the printhead if recommended in the report. See [To print the Print Quality Diagnostic Report on page 88](#).

Lines are blurred

Humidity can cause ink to soak into the paper, making the lines blurred and fuzzy.

Try the following:



1. Check that your environmental conditions (temperature, humidity) are suitable for high-quality printing. See [Environmental specifications on page 178](#).
2. Check that the paper type selected in the control panel is the same as the paper type you are using. See [View information about the paper on page 35](#).
3. Try changing to a heavier paper type, such as HP Heavyweight Coated Paper.
4. Select a higher print quality (such as **Normal** or **Best**), the printer will then use more time to dry ink.
5. Select a paper type that is slightly thinner than the paper you have loaded; this will persuade the printer to use less ink. Here are some example paper types in ascending order of thickness: Plain Paper, Coated Paper, Heavyweight Coated Paper.
6. Print the Print Quality Diagnostic Report, and align the printhead if recommended in the report. See [To print the Print Quality Diagnostic Report on page 88](#).

Line lengths are inaccurate

If you have measured your printed lines and find that the lengths are not sufficiently accurate for your purposes, you can try to improve line length accuracy.

Try the following:

1. Print on HP Heavy Weight Coated, for which your printer's line length accuracy is specified. See [Functional specifications on page 176](#).
2. Set Print Quality to **Best**.

3. Maintain the room at a steady temperature between 10 and 30°C (50 and 86°F).
4. Load the roll of film and let it rest for five minutes before printing.
5. If you are still not satisfied, try recalibrating the paper advance. See [Recalibrate the paper advance on page 94](#).

Whole image is blurry or grainy

There are a series of steps and checks you can make to deal with this issue. Check the paper, settings, run reports to find the issue etc.



1. Check that the paper type you have loaded corresponds to the paper type selected in the control panel and in your software. If you have doubts about the paper selection, see [Paper type is not in the driver or control panel on page 106](#).
2. Check that you are printing on the correct side of the paper.
3. Check that you are using appropriate print-quality settings (see [Printing on page 38](#)). In some cases, you can overcome a print-quality problem merely by selecting a higher print-quality level. For instance, if you have set the Print Quality to **Fast**, try using **Best**.
4. Print the Print Quality Diagnostic Report, and align the printhead if recommended in the report. See [To print the Print Quality Diagnostic Report on page 88](#).
5. If the problem remains, perform a paper advance calibration: see [Recalibrate the paper advance on page 94](#).

If the problem persists despite all the above actions, contact your customer service representative for further support.

Paper is not flat

If the paper does not lie flat when it comes out of the printer, but has shallow waves in it, you are likely to see defects in the printed image, such as vertical stripes. This can happen when you use thin paper that becomes saturated with ink.





1. Check that the paper type you have loaded corresponds to the paper type selected in the control panel and in your software. If you have doubts about the paper selection, see [Paper type is not in the driver or control panel on page 106](#).
2. Try changing to a thicker paper type, such as HP Heavyweight Coated Paper.
3. Select a lower print quality (such as **Fast**); the printer will then use less ink.
4. Select a paper type that is slightly thinner than the paper you have loaded; this will persuade the printer to use less ink. Here are some example paper types in ascending order of thickness: Plain Paper, Coated Paper, Heavyweight Coated Paper.

Print is scuffed or scratched

Pigmented ink can be scuffed or scratched when touched by a finger, a pen or some other object. This is particularly noticeable on coated paper.

Glossy paper may be extremely sensitive to the bin or to anything else that it contacts soon after printing, depending on the amount of ink used and the environmental conditions at the time of printing.

To reduce the risk of scuffs and scratches:

- Handle prints carefully.
- Avoid stacking prints on top of each other.
- Increase the drying time. At the control panel, tap the **Menu** icon , then **Settings**  > **General** > **Extra Dry Time**.

Ink marks on the paper

This problem can occur for several different reasons.

Horizontal smears on the front of coated paper

If a lot of ink is used on plain or coated paper, the paper absorbs the ink quickly and expands. As the printhead moves over the paper, the printhead may come into contact with the paper and smear the printed image.

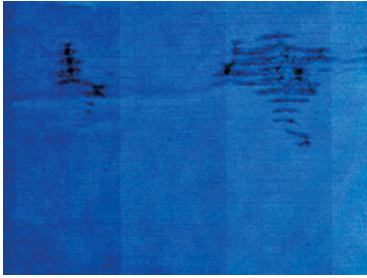

Whenever you notice this problem, cancel the printing job immediately. Soaked paper can damage the printhead.

If you notice poor print quality after this has happened, clean the printhead. [Clean the printhead on page 89.](#)

1. Check that the paper type you have loaded corresponds to the paper type selected in the control panel and in your software. If you have doubts about the paper selection, see [Paper type is not in the driver or control panel on page 106](#).
2. Use a recommended paper type (see [Order paper on page 101](#)) and the correct print settings.
3. If you see that the paper wrinkles, it is most likely because the paper is too thin. Try changing to a thicker paper type such as HP Heavyweight Coated Paper.
4. Select a paper type that is slightly thinner than the paper you have loaded; this will cause the printer to use less ink. Here are some example paper types in ascending order of thickness: Plain Paper, Coated Paper, Heavyweight Coated Paper.
5. Try to increase the margins by relocating the image to the center of the page using your software application.

Ink marks on the back of the paper

Clean the platen with a soft cloth. Clean each rib separately.

Black ink comes off when you touch the print

This problem may be caused by printing with matte black ink on glossy paper. The printer will not use matte black ink if it knows that the paper will not retain it.

To be sure of avoiding matte black ink, you can select **Photo Glossy Paper** as the paper type (in the **Photo Paper** category).

Edges of objects are stepped or not sharp

If edges of objects or lines appear to be poorly defined or lighter in density, and you have already set the print-quality slider to **Best**, try setting print quality to **Normal**.



If the problem still persists, try rotating the image.

Edges of objects are darker than expected

You might see darker edges in some areas of the plot that cause local color variations. Try setting print quality to **Best**.



See [Printing on page 38](#) for more information.

If the problem still persists, try rotating the image.

Vertical lines of different colors

If your print has vertical bands of different colors along it try changing the paper and/or adjusting the print-quality settings.

1. Try using thicker paper, choosing from the recommended paper types such as HP Heavyweight Coated Paper. See [Order paper on page 101](#).
2. Try using higher print-quality settings (see [Printing on page 38](#)). For instance, if you have set the Print Quality to **Fast**, try setting it to **Best**.

White spots on the print

You may notice white spots on the print. This is probably due to paper fibers, dust or loose coating material.

To avoid this problem:

1. Try cleaning the paper manually with a brush before printing, to remove any loose fibers or particles.
2. Always keep the cover of your printer closed.
3. Protect your paper rolls and sheets by storing them in bags or boxes.

Colors are inaccurate

If the colors of your print do not match your expectations, there are steps you can take.

Try the following:

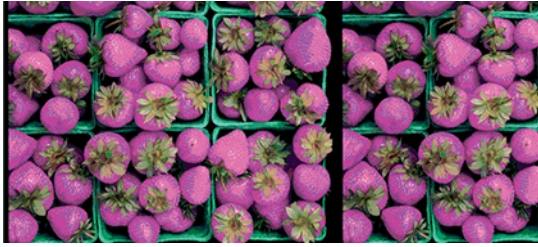

1. Check that the paper type you have loaded corresponds to the paper type selected.
2. Check that you are printing on the correct side of the paper.
3. Check that you are using appropriate print-quality settings. For the most accurate colors, select **Normal** or **Best** quality.
4. If using glossy paper, check that you are using the supported paper type. See [Order paper on page 101](#) and ensure the glossy paper is compatible with pigment inks.
5. Print the Print Quality Diagnostic Report. See [To print the Print Quality Diagnostic Report on page 88](#).

Colors are fading

The inks used by this printer are designed for minimal color fading over time. However, lamination will increase the life of prints (depending on the type of lamination) with all paper types.

Check you are using a recommended paper type (see [Order paper on page 101](#)). For more information about lamination, consult your laminate provider.

Image is incomplete (clipped at the bottom)

If the image is incomplete you may have cut the data being received, or there could be a communication issue.

- Did you tap **Cancel** before all the data were received by the printer? If so, you have ended the data transmission and will have to print the page again.
- There may be a communications problem between your computer and the printer. Check your network cable, or your Wi-Fi connection.
- Check to make sure that your software settings are correct for your current page size (for example, long-axis prints).
- If you are using network software, make sure it has not timed out.

Image is clipped

Clipping normally indicates a discrepancy between the actual printable area on the loaded paper and the printable area as understood by your software.

- Check the actual printable area for the paper size you have loaded.
printable area = paper size - margins (5×5×5×5 mm 0.2×0.2×0.2×0.2 in)

- Check what your software understands to be the printable area (which it may call "printing area" or "imageable area"). For example, some software applications assume standard printable areas that are larger than those used in this printer.
- If you have defined a custom page size with very narrow margins, the printer may impose its own minimal margins, clipping your image slightly. You may want to consider using a larger paper size.
- If your image contains its own margins, you may be able to print it successfully by using the **Clip Contents by Margins** option (see [Select margins options on page 40](#)).
- If you are trying to print a very long image on a roll, check that your software is capable of printing an image of that size.
- You may have asked to rotate the page from portrait to landscape on a paper size that is not wide enough.
- If necessary, reduce the size of the image or document in your software application, so it fits between the margins.

Some objects are missing from the printed image

Large quantities of data may be necessary to print a high-quality large-format print job, and in some specific workflows there may be issues that can lead to some objects missing from the output.

Here are some suggestions to help you to avoid this problem:

- Select a smaller page size and scale to the desired final page size in the driver or in the control panel.
- Save the file in another format, such as TIFF or EPS, and open it with another application.
- Reduce the resolution of bitmap images in your application software.



NOTE: If you're using Adobe applications, ensure that you have installed the latest version.

These options are suggested for troubleshooting purposes and may adversely affect the final output quality or the time necessary to generate the print job. Therefore, they should be canceled if they do not help to solve the problem.

How to avoid further issues

There are things you can do to help avoid future issues, or to try if you still haven't found a solution to an problem you are experiencing.

- Try using a higher print-quality option. See [Printing on page 38](#).
- Check the driver you are using to print with. If it is a non-HP driver, consult the driver vendor about the issue, or better still; and if feasible, try using the correct HP driver. You can download the latest HP drivers from the HP website. See [Printer solutions on page 11](#).
- Regularly update the firmware in your printer.
- Always check that you have the correct settings in your software application.

15 Troubleshooting scanner issues

Cannot access the network folder

Make sure your computer is using the same network as the printer. If it is, then follow the suggested checks to correct any issue.

If you have set up a network folder (see [Scan to network setup process on page 58](#)), but the printer cannot access it, try the following suggestions:

- Check that you have filled in each field correctly.
- Check that the printer is connected to the network.
- Check that the remote computer is switched on, working normally and connected to the network.
- Check that the folder is shared.
- Check that you can put files into the same folder from a different computer on the network, using the printer's logon credentials.
- Check that the printer and the remote computer are in the same network subnet; if they are not, check that the network routers are configured to forward the CIFS protocol traffic (also known as Samba).

Scanning to file is slow

Scanning large formats creates large files. This means that scanning to file can take time even under optimal system configurations and conditions.

This issue is especially true when scanning across a network. However, if you think scanning to file with your system is unreasonably slow, the following steps may help you to locate and solve the problem:

1. Use the control panel to check the status of your scan job. If it is taking an intolerably long time, you can cancel it.
2. Check that the **Resolution** setting is right for the job. Not all scanning tasks require high resolutions. If you lower the resolution, you will speed up the scanning process. For JPEG and PDF scan jobs, you can also change the **Quality** setting. Lower quality values produce smaller files.
3. Check your network configuration. Your network should be a Gigabit Ethernet or one of a higher transfer rate in order to achieve optimal scanning speeds. If your network is a 10/100 Ethernet configuration, you can expect slower transfer of the scan data and thus slower scanning speeds.
4. Contact your network administrator for information about your network configuration, transfer rates, scan-to-file destinations on the network and possible solutions for increasing the speeds.
5. If scanning to files on the network is too slow and the network configuration cannot be amended to correct this, improved speeds can be achieved by scanning to a USB flash drive.
6. If scanning to a USB flash drive seems slow, check your USB flash drive interface compatibility. Your system supports a Hi-Speed USB interface. Your USB flash drive should be compatible with

Hi-Speed USB (sometimes known as USB 2). Also check that your USB flash drive contains enough storage space for scanned large-format images.

Original document is reloaded while scanning

It may happen that, while scanning, the original document is accidentally loaded back into the scanner, causing a loop.

If this happens:

1. Open the scanner lid.
2. Carefully remove the original document.
3. Close the lid.
4. Check that the refeed preventers are correctly installed.

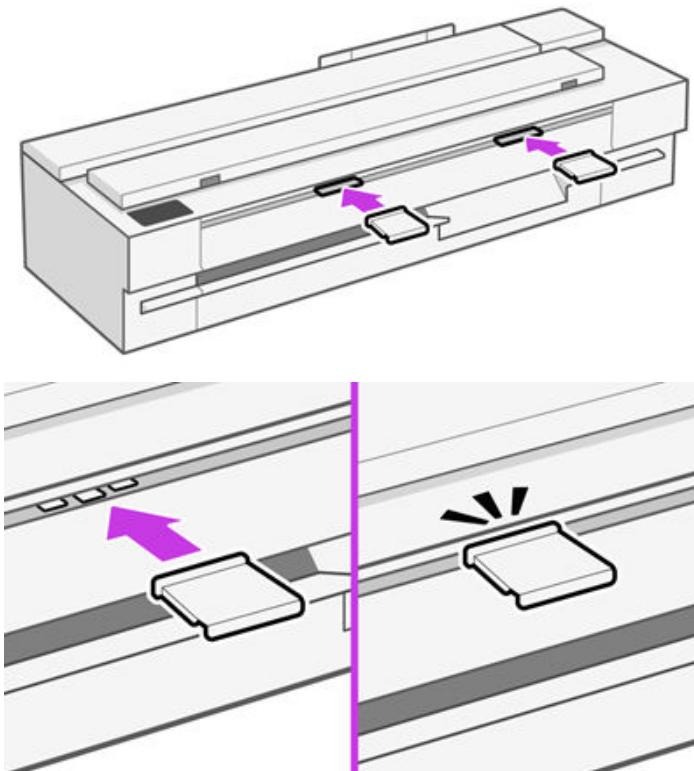

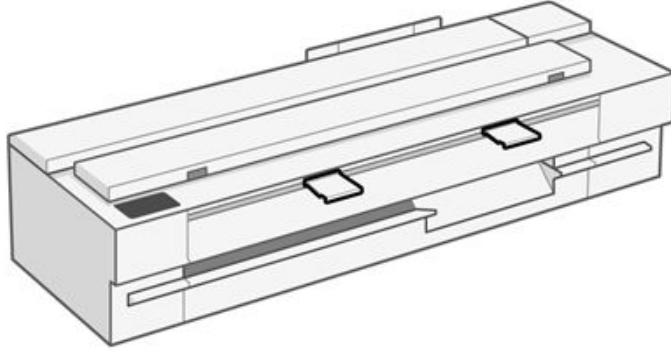

The refeed preventers are designed to prevent this situation from occurring. Make sure that they are always installed.

16 Troubleshooting copy and scan quality issues (only MFP)

A defect is a common image artifact that usually appears when using any CIS scanner. These are due to incorrect settings, product limitations, or easily solvable mistakes. A failure mode is due to malfunctions of some of the scanner components.

In this chapter the most common defects and failure modes are shown, sorted by relevance and frequency of appearance.

Scanner cleanliness is paramount to ensure good image quality. Before proceeding with any troubleshooting, make sure the glass scanbars are clean and in good condition and the pressure sliders (wide, white plastic parts) are also in good and clean condition. See [Clean the scanner scanbars on page 95](#).

Some of the corrective actions proposed here require the use of the scanner diagnostic plot, which you can print and scan as indicated in [The scanner diagnostic plot on page 151](#). When copying, to be sure that the defect does not come from the printing function, use this diagnostic plot to detect any scanning issue. Do not use any printed version of this guide to test the scanner, as the resolution of the images included here is insufficient. Use the diagnostic plot when recommended in response to any of the errors described in this chapter.

Random vertical lines

This is one of the most common issues in sheet-fed scanners. Usually, the vertical streaks are caused by dust particles inside the scanner, or miscalibration of the scanner (in these cases, the problem can be solved).

Here are some examples of images suffering from vertical lines or streaks:

 **NOTE:** The black arrow indicates the scanning direction.



1. Clean the scanner's glass scanbars and the original to be scanned as described in [Clean the scanner scanbars on page 95](#). Restart the printer and re-scan your original afterwards.
2. If the streaks remain, recalibrate the scanner as indicated in [Calibrate the scanner on page 97](#). Restart the scanner and re-scan your original after the calibration is completed.
3. If the streaks still remain, check the scanner's glass scanbars and sliders visually. If they are damaged (scratched or broken), call HP support.

 **NOTE:** The problem of vertical streaks cannot always be solved, due to the technological limitations of CIS technology. If the streaks remain after the corrective actions explained above, then no further action can be taken to improve the image quality, except to buy a more expensive CCD scanner. HP offers HD Scanners with CCD technology for customers with higher quality requirements.

Wrinkles or folds

Scanners based on CIS technology have a high optical resolution within their focus plane, at the price of a very limited depth of field. Hence, the images are sharp and detailed when the scanned original is perfectly flat against the glass plate.

However, whenever the original contains wrinkles or folds, these defects are clearly visible in the scanned image (as shown in the following example):

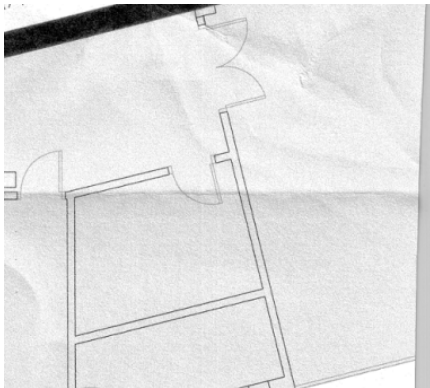

1. Re-scan the original and set the background color and noise removal to **Off**. If copying, set the content type to **IMAGE**.
2. If the problem persists, re-scan the original at a lower scanner resolution (300 dpi or lower resolution if scanning, Fast or Normal if copying). It may also help to flatten the original manually as much as possible before scanning it again.

 **NOTE:** The problem of wrinkles cannot always be solved, due to the technological limitations of CIS technology. HP offers HD Scanners with CCD technology for higher quality requirements. If the wrinkles remain after the corrective actions explained above, then no further action can be taken to improve the image quality, except to buy a more expensive CCD scanner.

Line discontinuities

When scanning or copying large originals, you may sometimes find issues such as that shown in the following image, where a straight line (it does not necessarily have to be horizontal) appears with discontinuities or small steps.

 **NOTE:** The black arrow indicates the scanning direction.

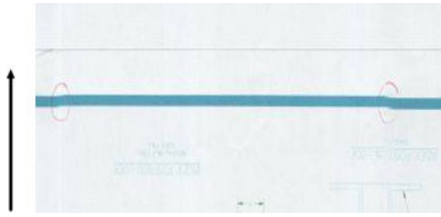

1. Repeat the scan, making sure that the product is correctly positioned: it is flat on the floor and it does not move. Turning the original 90 or 180 degrees and scanning it again may also solve the problem.
2. If the problem persists, check that the original to be scanned is not skewed, and that it does not become skewed during the scan. If so, see [Incorrect paper advance, skew during scanning, or horizontal wrinkles on page 145](#). You might also want to deactivate the automatic de-skew algorithm as indicated in [A copied or scanned image is very skewed on page 150](#).
3. If there is no skew but the problem persists, clean and calibrate the scanner as indicated in [Clean the scanner scanbars on page 95](#) and [Calibrate the scanner on page 97](#). Take care not to move the printer during the calibration, and check that the maintenance sheet is correctly positioned before starting the calibration. Also check that the maintenance sheet is not damaged before calibrating the scanner (an old or damaged maintenance sheet may cause this problem); if it is damaged, reprint it as explained in Calibrate the scanner (see [Calibrate the scanner on page 97](#)).
4. If the problem persists, proceed to analyze the following areas of the diagnostic plot:
 - D, H and L (for three modules, 0-Left, 1-Middle, and 2-Right and its intersection)

If you see any of these defects in the studied areas, call HP support and report a “line discontinuities” error after calibration.

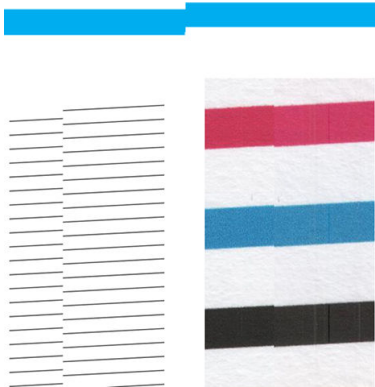

The four vertical thin black lines at the beginning and the end of the diagnostic plot show, approximately, the position of the intersection between scanbars, where this kind of error usually appears. If the error appears outside these areas, call HP support and report “line discontinuities within a scanbar”.

Light-colored area fills are missing in the scan or copy

When scanning or copying a map with a light area at the top, the **Background color removal** setting could interpret it as a background color, therefore removing it and other similar areas.

In the example below the original is on the left, the scanned image on the right:

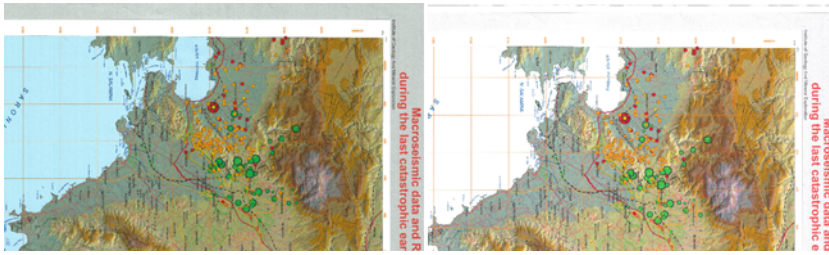

1. Repeat the scan or copy with **Background color removal** set to **Off**, or, in the case of copying, you can select **Image** as the content type. See [Scan settings on page 56](#) and [Copy settings on page 68](#).
2. If the problem persists, clean and calibrate the scanner as indicated in [Clean the scanner scanbars on page 95](#) and [Calibrate the scanner on page 97](#). Repeat it again with **Background color removal** set to **Off**.

Grain in area fills when scanning plain paper

When making copies of an original containing area fills, if the paper used in the printer is plain paper (for instance, HP Universal Bond or HP Bright White Inkjet Bond), some grain may appear in the image.

This error may also appear in scanned files of originals that were printed on textured paper.

In the example below the original is on the left, the scanned image on the right:



1. Look at the original and check whether it is dirty, has fingerprints on it, or has grain already present in the print. If not, then proceed to step 2.
2. If it is a copy, repeat it, setting the content type to **Image**.
3. If the problem persists:
 - If the problem appears when copying, use Best quality. We also recommend using coated or glossy paper in order to avoid grain in copies.
 - If the problem appears in a scanned file, scan at a lower resolution (300 dpi or lower resolution).
4. If the problem persists, clean and calibrate the scanner as indicated in [Clean the scanner scanbars on page 95](#) and [Calibrate the scanner on page 97](#). Check that the maintenance sheet is also clean, and that it is not damaged before calibrating the scanner (an old or damaged maintenance sheet may cause this problem); if it is damaged, reprint it as explained in [Calibrate the scanner](#) (see [Calibrate the scanner on page 97](#)).

5. If the problem persists, proceed to analyze areas I and J of the diagnostic plot across modules =, 1 and 3. In the three examples below, the top example is ideal, the middle example can be regarded as acceptable; but, if you see something similar to the bottom example (or worse), call HP support and report “grain in area fills”.

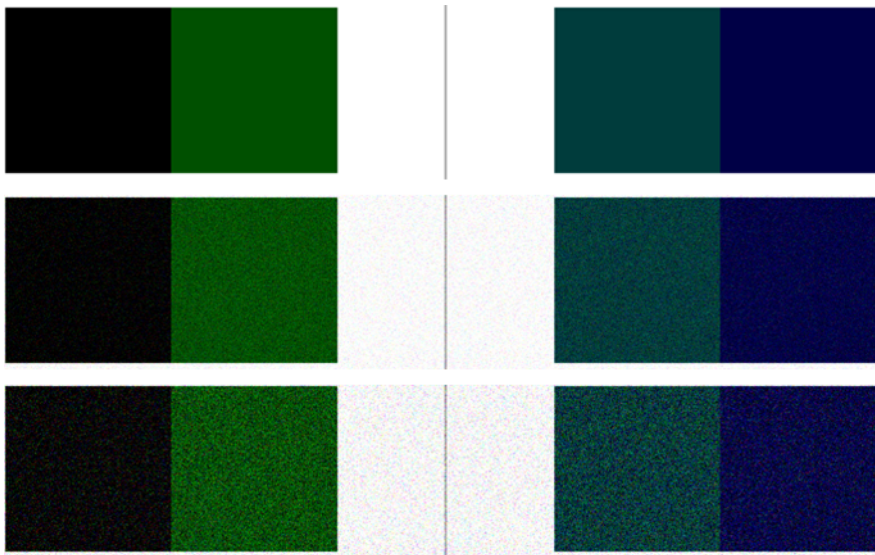

Small color differences between adjacent scanbars

When scanning wide plots, sometimes slightly different colors can be seen at both sides of the junction between two scanbars. This issue, if present, can be easily seen by analyzing patterns A and G of the diagnostic plot at the intersection between scanbars.

Here are some examples:

 **NOTE:** The black arrow indicates the scanning direction.

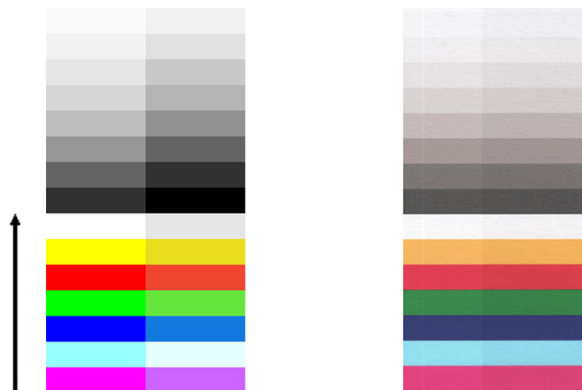

Sometimes the color mismatch between adjacent modules can be enormous, showing a serious scanner malfunction, as in the following example. If this occurs, see [Completely wrong colors on page 147](#).



1. Restart the scanner and repeat the scan or copy. If the problem persists, repeat the scan or copy, toggle the background color removal to Off or turning the original 90 degrees before scanning it again.
2. If the problem persists, clean and calibrate the scanner as indicated in [Clean the scanner scanbars on page 95](#) and [Calibrate the scanner on page 97](#). If calibration ended without errors, try to scan or copy again.
3. If the problem persists, proceed to analyze patterns A and G in the diagnostic plot, if you see some color differences between left and right sides of the bars for neutral and vivid colors, call HP support and report "small color differences between adjacent ". Otherwise, if you see color differences for vivid colors but not for neutral colors, see [Clipping in dark or light areas on page 142](#). If necessary, see also [Grain in area fills when scanning plain paper on page 137](#).

Vertical light lines at the intersection between scanner scanbars

This problem can be found when scanning large uniform area fills which are made of some light color. You sometimes find light vertical bands (around 0.5 cm wide) at the intersection between two scanbars.

Example:



NOTE: The black arrow indicates the scanning direction.



1. Repeat the scan or copy, restarting the printer and setting the background color removal to Off or turning the original 90 degrees before scanning it again.
2. If the problem persists, clean and calibrate the scanner as indicated in [Clean the scanner scanbars on page 95](#) and [Calibrate the scanner on page 97](#). Then proceed to analyze pattern number B of the diagnostic plot at the intersections between scanbars. The example below shows a good result

on the left and a bad result on the right: the latter has light vertical banding 0.5 cm wide at the intersection between two scanbars.



If you see the kind of result shown on the right, call HP support and report “vertical light bands in area fills at the intersection between scanbars, after calibrating the scanner”.

Variable line thickness or missing lines

When scanning some CAD plots at low resolution, mostly when working with grayscale or black-and-white prints that contain very thin lines, you may see a variation in line thickness, or even some missing lines, in some places.

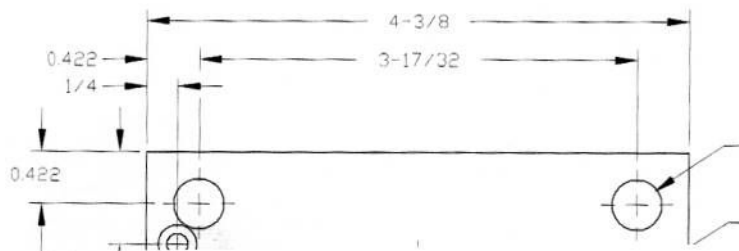

1. Repeat the scan or copy using a higher resolution (600 dpi) or **Best** if copying. You should also toggle **Background color removal** to **Off**, or, for copying, set **Content type** to **Mixed**. You might also deactivate the automatic de-skew as explained in [A copied or scanned image is very skewed on page 150](#). In case you were working in black-and-white mode, we recommend using grayscale instead.
2. If the problem persists, turn the original plot 90 degrees before scanning it again.
3. If the problem persists, clean and calibrate the scanner as indicated in [Clean the scanner scanbars on page 95](#) and [Calibrate the scanner on page 97](#).
4. If the problem persists, see [Defocus, blurring and fading colors on page 144](#).

Inaccurately reproduced colors

You have to deal with several variables if you want perfect color matching between the original you are scanning and the copy or scanned file you obtain as a result.

If you find undesired colors in cases, you can follow these guidelines.

In the example below the original is on the left, the scanned image on the right:

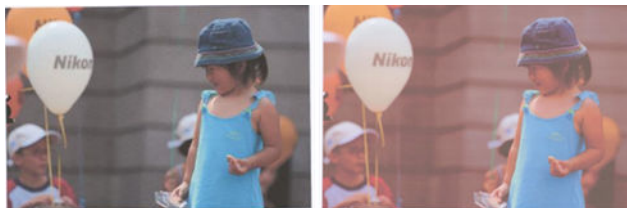

1. When dealing with copies, you must take into account that good color matching between a given original and its copy can be achieved only if both are printed on the same type of paper. In the case of scanned files, good color matching can be achieved only if your monitor is color-calibrated or compliant with sRGB or AdobeRGB standards.
2. Restart the printer and scan or copy again.
3. If you are making a copy on plain paper, try using HP plain paper with ColorPRO Technology (such as HP Universal Bond Paper), which makes colors more saturated, particularly when using pigmented inks.
4. If the above conditions are met, you should also take into account that various scanner settings can affect the final color result, such as lighter/darker, background color, noise removal, content type, and paper type. To obtain the best possible colors, set **Darker/Lighter** to **Normal**, **Background color removal** and **Noise removal** to **Off**, and **Content type** to **Image** (only if copying); and do not select **Translucent paper**. See [Scan settings on page 56](#) and [Copy settings on page 68](#).
5. For optimum color results, clean the scanbars (see [Clean the scanner scanbars on page 95](#)) and calibrate the scanner as indicated in [Calibrate the scanner on page 97](#).
6. Avoid placing the scanner in direct sunlight or near sources of heat or cold.

Color fringing

The problem called “color fringing” occurs when the scanner is affected by incorrect paper advance and/or miscalibration. Nevertheless, some amount of color fringing is unavoidable, especially at high scanning speeds.

Color fringing can be seen at the borders of sharp black text over a white background.

In the example below the original is on the left, the scanned image on the right:

 **NOTE:** The black arrow indicates the scanning direction.



1. Repeat the scan after increasing the scanner’s resolution (choose 300dpi or higher quality if scanning, Best if copying). Turn your original 90 degrees, if possible, before scanning it again.
2. If the problem persists, clean and calibrate the scanner as indicated in [Clean the scanner scanbars on page 95](#) and [Calibrate the scanner on page 97](#).
3. If the problem still persists, you can diagnose this issue by analyzing the E patterns of the diagnostic plot. The black horizontal lines appear slightly colored at the top and bottom of each end (in the example on the right, below). Normally, they look red at the top and blue or green at the bottom, but it could be the other way around.



If you see this effect, call HP support and report “color fringing problem after calibration”.

Clipping in dark or light areas

Sometimes you may see that the scanned file or copy of one of your plots has lost detail in light or dark areas (or both).

In the example below the original is on the left, the scanned image on the right:



Image © www.convincingblack.com, reproduced with permission.

1. If you are making copies, and the original is printed on photographic paper, while you are copying it onto matte paper, this problem is to be expected. However, you can try to restart the printer and set the background color and noise removal to Off and also change the Lighter/Darker settings; this also applies if you see this problem in scanned files.
2. If the problem persists, repeat the scan or copy using a higher resolution (300 dpi or higher if scanning, Normal or Best if copying). Set the content type to **Image** (if copying).
3. If the problem persists, recalibrate the scanner as indicated in [Calibrate the scanner on page 97](#). Make sure you clean the maintenance sheet before calibrating the scanner, and check that the maintenance sheet is not damaged (if so, reprint it as explained in [The scanner diagnostic plot on page 151](#)). Re-scan your original after the calibration is completed.
4. If the problem persists, analyze patterns M (0, 1 and 2 modules) of the diagnostic plot. If you can distinguish lightness steps beyond the upper and lower specified thresholds, then the scanner is fine. Here you can see some examples of correct and incorrect functioning.

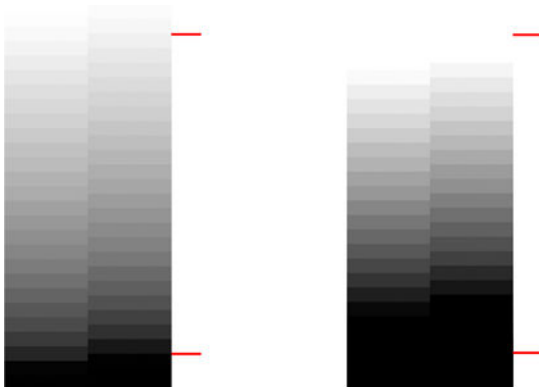

If your scanned pattern looks like the incorrect one on the right, whether the clipping is in dark and/or light areas, call HP support and report “Clipping in dark/light areas”.

Flare in the image when scanning glossy originals

If the scanner is miscalibrated, or if the original plot you are trying to scan is very glossy or reflective, you can sometimes find flare in the scanned image.

In the example below the original is on the left, the scanned image on the right:



Image © www.convincingblack.com, reproduced with permission.

1. Clean the original and the scanner's glass plate, then scan again. See [Clean the scanner scanbars on page 95](#)
2. If the problem persists, recalibrate the scanner as indicated in [Calibrate the scanner on page 97](#). Re-scan your original after the calibration is completed.
3. If the problem persists, see [Clipping in dark or light areas on page 142](#).

Vertical red and green bands over white or black background

If the scanner has not been calibrated for a long period of time, or if the last calibration failed, you can sometimes see defects.

Example:



NOTE: The black arrow indicates the scanning direction. The original is on the left, the scanned image on the right.

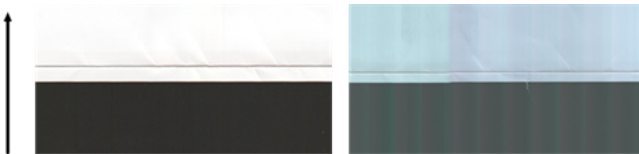

1. First, restart the printer and re-scan or copy. Clean and calibrate the scanner as indicated in [Clean the scanner scanbars on page 95](#) and [Calibrate the scanner on page 97](#). If the calibration failed, proceed as stated in [Calibrate the scanner on page 97](#). However, if the calibration ended correctly, scan your original again and check that the colored vertical bands have disappeared.
2. If the problem persists, call HP support and report "vertical red/green bands after calibration".

Vibration

If your printer is not properly placed on a flat surface, or if the scanner lid does not close correctly, you may sometimes find that the scanned image suffers from vibration.

In the example below the original is on the left, the scanned image on the right:



1. Make sure that the scanner is placed on a flat surface and the scanner lid is correctly closed. Scan your original again.
2. If the problem persists, change (increase or decrease) the scanning resolution and re-scan your original. We also recommend turning the original 90 degrees before scanning it again.
3. If the problem persists, analyze pattern D of the diagnostic plot. If you see the problem shown on the right, call HP support and report a “vibration problem”.

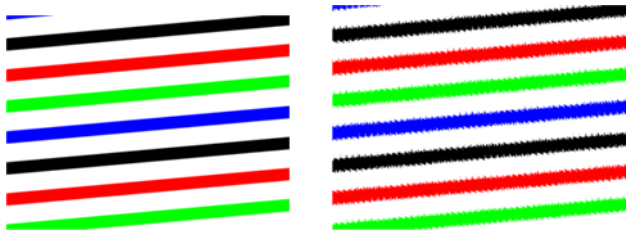

Defocus, blurring and fading colors

CIS technology scanners are tuned to work at a fixed focal distance, and they are very sensitive to small variations in the position of the original with respect to the scanner glass plate.

If the scanner lid is not properly closed, or if the original has deep wrinkles or texture, you may sometimes find problems as in the following example (on the right), where the scanned image is blurred and colors are faded:



1. Check that the scanner lid is properly closed. Open and close the scanner lid by pushing it down until you hear a click. Calibrate the scanner as indicated in [Calibrate the scanner on page 97](#), then restart and repeat your scan.
2. If the problem persists, repeat the scan or copy using a higher resolution (300dpi or more if scanning, Normal or Best if copying). You should also set background color removal to Off, or set the content type to **Mixed**, if copying.

3. If the problem persists, analyze pattern F in modules 0, 1 and 2 of the diagnostic plot. A correct example is given below, followed by two incorrect examples. Note that there is a black ring near the center of pattern F. In this step, you must look at the region near the black ring. If you can see discontinuities in the black and white lines, call HP support and report a “defocus or blurring” error.

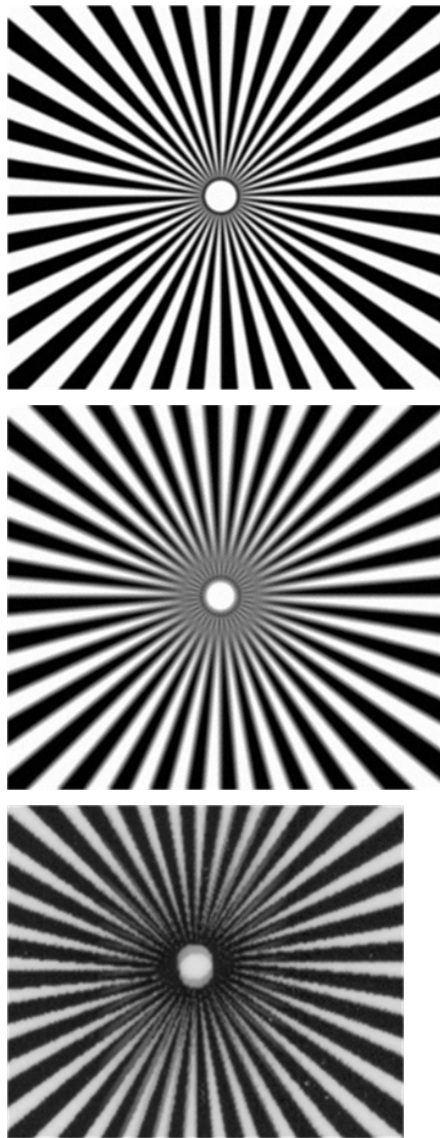

Incorrect paper advance, skew during scanning, or horizontal wrinkles

You may encounter problems with some thick glossy originals being moved through the scanner’s paper path. In some cases, the original may become skewed during the scanning process.

If some of the paper rollers are not working correctly, you may find small horizontal wrinkles in the scanned image, due to the paper being stuck in some regions while not in others.

1. Turn your original 90 degrees and repeat your scan.

2. If the problem persists, open the scanner lid. Clean the feed wheels (small black rubber) and the pressure sliders (wide white plastic). If you find dust particles or objects that obstruct the movement of the pressure sliders, try to remove them, then close the scanner lid and repeat your scan.
3. If the problem persists, restart the scanner by turning it off and on again. If you find an error message on the control panel during this operation, call HP support and report the error message. If no error message appears, try repeating your scan.
4. If the problem persists, analyze patterns D, K and L of the diagnostic plot. The plot should look like this:



If you see an image resembling the incorrect examples below, call HP support and report an “incorrect paper advance” problem.



Vertical black band 30 cm wide

Your scanner contains various scanner scanbars, each of which covers an area 30 cm (12 in) wide.

If one of the modules fails, and the scanner hardware check does not detect the failure, you may see a black vertical band, corresponding to the area covered by a single scanbar, in your scanned image or copy. Here is an example (on the right):

 **NOTE:** The black arrow indicates the scanning direction.



Original Scan affected by a failing scanbar

1. Restart the scanner by turning it off and on again. If you find an error message on the control panel during this operation, call HP support and report the error message. If no error message appears, try repeating your scan.
2. If the problem persists, try to calibrate the scanner as indicated in [Calibrate the scanner on page 97](#). If this operation fails, call HP support with the error code given on the control panel. If no error code appears, try to repeat your scan.

3. If the problem persists, call HP support and report a “vertical black band 30 cm wide”.

The scanner damages some originals

This scanner may cause vertical scratches on thick glossy paper printed on by inkjet printers.

Old prints or very thin tracing paper may also be damaged. This is because CIS technology requires the original to be held down with high pressure to obtain accurate results and avoid blurring and defocus problems.

If the original you intend to scan is valuable, and if it belongs to one of the types described above (inkjet-printed, thick, glossy original or old/thin/tracing paper original), HP recommends using a CCD scanner.

Completely wrong colors

If some of the LEDs used for illumination in the scanner scanbars are failing, or the last calibration did not work correctly, although no error message was given on the control panel, you may experience some completely wrong colors in your scanned images.

In the example below the original is on the left, the scanned image on the right:

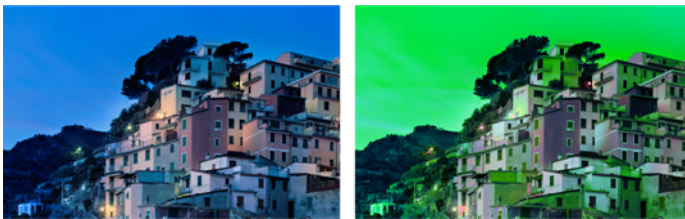

1. Restart the scanner by turning it off and on again. If you find an error message on the control panel during this operation, call HP support and report the error message.
2. If no error message appears on the control panel during the restart process, try to calibrate your scanner, as indicated in [Calibrate the scanner on page 97](#), once it is fully functional. If some error message appears on the control panel, call HP support and report the error, adding that you found it after seeing “completely wrong colors in the scanned image”.
3. If calibration succeeded, restart and repeat your scan, and check the colors.
4. If the colors are still wrong, analyze the whole diagnostic sheet. Check that you find completely wrong colors in the area corresponding to just one of the scanbars, as in the following figure. If so,

call HP support and report “completely wrong colors after calibration”, and report the letter of the scanbar that is failing (module A in the example).

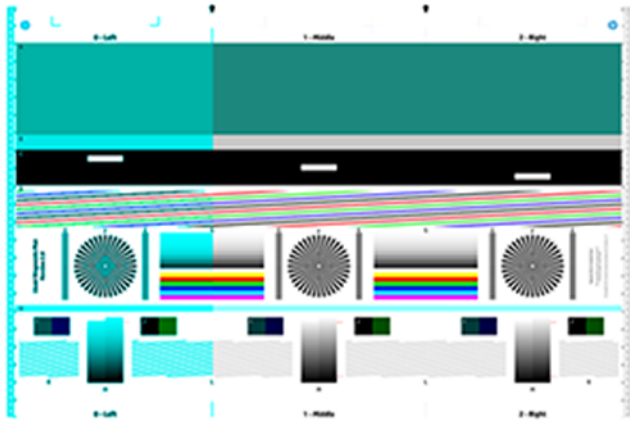

If all the modules are failing, call HP support and report that.

Vertical distortion

If the lid sensor of the scanner fails, the scanner cannot detect when the lid is open. Hence, you can start a scan, and at some point find that the pressure sliders do not move the original through the scanner paper path.

In the example below the original is on the left, the scanned image on the right:

 **NOTE:** The black arrow indicates the scanning direction.

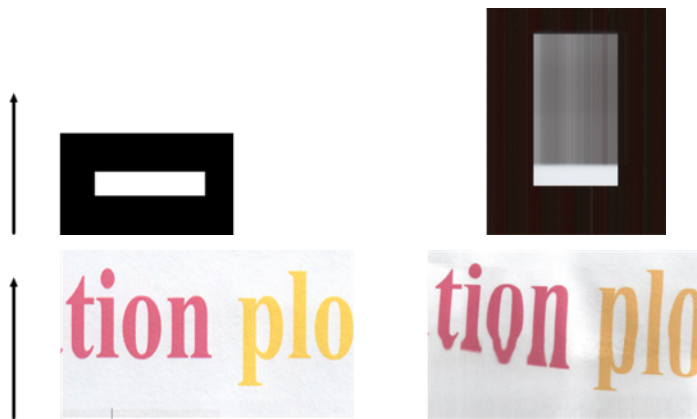

- Open and close the scanner lid by pushing it down until you hear a click. Then repeat your scan and visually check that the original advances correctly through the scanner path. If not, call HP support and report an “incorrect paper advance” error. Remember that your scanner is not intended to work with originals thicker than 0.75 mm (29 mil).

Object replication (ghosting)

This error very rarely appears in CIS scanners. However, you can occasionally find image defects.

In the example below the original is on the left, the scanned image on the right:



Image © www.convincingblack.com, reproduced with permission.

1. Restart your printer. Then calibrate the scanner, as indicated in [Calibrate the scanner on page 97](#), and repeat your scan. Turn the original 90 degrees if possible before re-scanning. You can also try modifying the Lighter/Darker setting.
2. If the problem persists, analyze pattern C, modules 0, 1 and 2, of the diagnostic plot. Call HP support and report an “object replication” issue if you see the kind of error shown on the right.



Clipping or incorrect scale factor when down-scaling in copies and prints

When doing copies or prints (from USB, Embedded Web Server, or printer driver), the scaling setting is available with various possible options.

If you are experiencing problems related to border clipping, or it seems that your print has lost the scale-factor adjustment, read this section carefully in order to select the best value for the scaling setting in future jobs.

- **Output scale: Custom (Precise scaling):** In this case, the content of the original image is scaled by the percentage factor that you have selected. For example, in an original CAD image with a 1:100 scale, if user selects scale to 50%, the printed plot will have an accurate scale of 1:200. Nevertheless, in the case of down-scalings when selecting a fixed percentage, some clipping of the marginal content of the plot may occur, as it is impossible for the printer to print up to the borders of the paper.
- **Output scale: Standard sizes (Scale to fit into page size):** In this case, the content of the original image is scaled by the percentage necessary to make sure that all the content is correctly printed and no clipping occurs. Nevertheless, in the case of down-scalings when selecting fit to page, the scale-factor adjustment may not be an integer divisor of the original. For example, in an original CAD plot with a 1:100 scale on A2 paper size, if user selects scale to fit on A3 paper size, the scaling factor will not be exactly 50% and the scale of the printed plot will not be 1:200 exactly. However, the plot will be printed completely without clipping any content.

Incorrect edge detection, mostly when scanning tracing paper

Tracing or translucent papers can be scanned with good results, although totally transparent papers are not supported.

Nevertheless, the resulting image may have extra margins or some clipping of the content in some situations when detection of the edge of the paper is not accurate, which may also happen when scanning plain paper if the glass plate is dirty. In order to avoid these undesired effects, follow these recommendations.

1. Carefully clean the scanner's glass plate and the original to be scanned with a cloth. Turn the original 90 degrees if possible and re-scan it afterwards. Remember to select **Translucent** as the paper type at the scanner if your original is translucent.
2. If the problem persists, calibrate your scanner, and re-scan your original again afterwards.
3. If the problem persists in the case of translucent paper, attach a sheet of white paper to the back of the original to be scanned.
4. If the problem persists, try to scan with the scan edge-to-edge output setting set to ON.

A copied or scanned image is very skewed

Originals are often loaded into the scanner with some degree of skew. In order to correct for this unavoidable problem, the scanner has a built-in automatic de-skew algorithm, which measures the skew in the original and rotates the scanned image so that the result is perfectly straight.

However, in some cases the de-skew algorithm may increase the skew rather than correcting it. In other cases, the skew is so bad that it cannot be automatically corrected.

To load the original with minimum skew, grasp the original with the image facing up and your hands at left and right edges. You are recommended to avoid resting your hands or the original on the scanner's input tray. Push the original into the scanner insertion slot until you feel the whole top border of the original pressing against the scanner rubber rolls, which will load the original after a delay of 0.5 seconds. Now you can take your hands off the original. If you are not happy with the way the scanner has grabbed your original, you can touch the **Eject** icon  and try again.

The automatic de-skew can be deactivated from the **Options** button  at every new scanner job.

17 The scanner diagnostic plot

You can print the plot onto a roll or a single sheet but do not use recycled or tracing paper.



Prepare the printer and the paper to print the diagnostic sheet

Turn on your printer and wait until it is functioning. Then select the paper on which the diagnostic plot is going to be printed (you can reuse the diagnostic plot at any time in the future, if it is saved carefully).

 **NOTE:** Ideally, the diagnostic plot should be printed on Heavyweight Coated Paper; do not use recycled or tracing paper.

The size of the diagnostic plot is: 914 mm (36 in).

You can print on a roll or a single sheet, which should be of the maximum width accepted by the printer.

You can print the diagnostic plot from the control panel: tap the **Menu** icon , then **Tools**  > **Troubleshooting > Scanner Calibration.**

Visual check for errors while printing the diagnostic sheet

Once the diagnostic plot is printed, the first step is to check that all the patterns included in it are correctly printed.

The diagnostic plot, if printed correctly, should look like this:

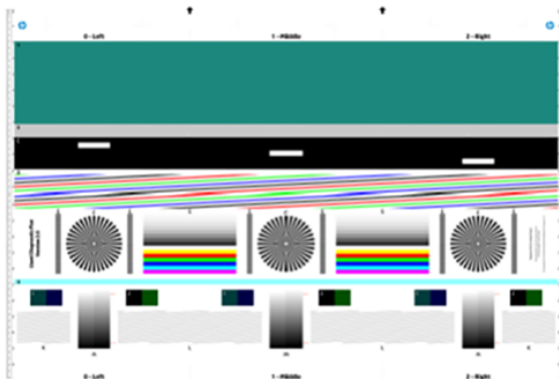

Some of the most common defects that may appear in a printed diagnostic plot are described below. If you find any of these problems, you should follow the recommended recovery procedure. See the [Troubleshooting print-quality issues on page 121](#). Once the printer has been diagnosed and it is working correctly, you can reprint the diagnostic sheet as described in [Prepare the printer and the paper to print the diagnostic sheet on page 151](#).

Resolution

By looking at pattern F you may find problems with the printer's resolution for the loaded paper. Usually, this test does not reveal a printer problem, but a defect in the paper, which may not be suitable for printing the diagnostic sheet with the required quality.

Here is what you should see if all is well, followed by two defective examples.

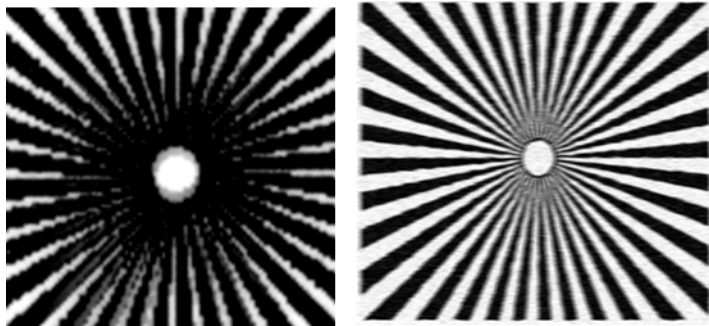
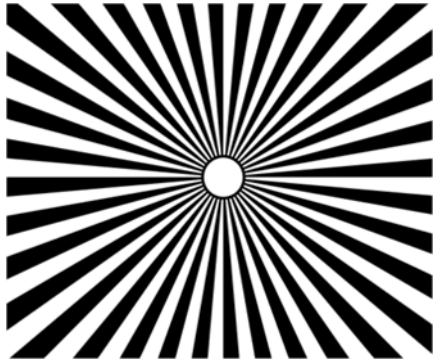

Alignment

Looking at patterns D, K, and L, you may find problems with the printer's printhead alignment.

This can cause defects such as the following:



Additionally, misalignment problems can be seen in patterns D and G in the form of color fringing (which is exaggerated below, on the right). That is, the limits between two strong colors are not well defined or a third color appears between them.

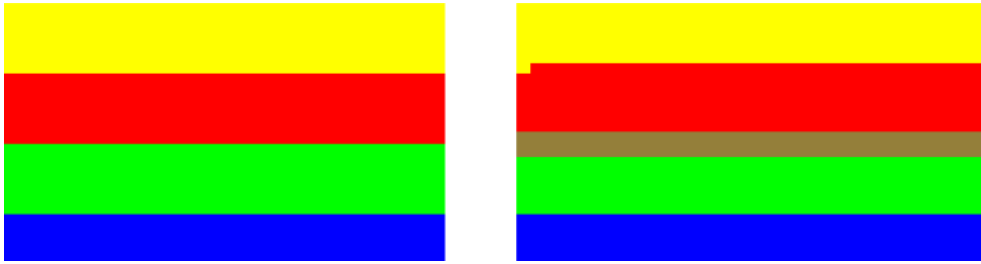

Finally, a special pattern for checking the printer's printhead alignment can be found at the top left of the diagnostic sheet. This pattern has no number as it is not used for scanner checking. It is made of three colored crosses that may be used to identify the problem in question. The correct pattern is shown on the left, an example of misalignment on the right.



Loss of shadow or highlight details

Looking at pattern H, you may find a problem with the printer or the paper. If you can distinguish lightness steps beyond the upper and lower specified thresholds, then the printer is fine.

Here you can see examples of correct functioning on the left, incorrect on the right:

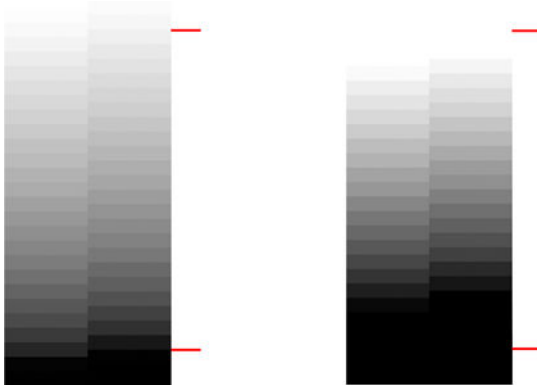

If the printer does not pass this test, you should check that you have correctly selected the paper type and the Best quality.

Printer banding

Looking at patterns A, B, and C, you may see vertical banding problems.

Example:



See [Horizontal lines across the image \(banding\) on page 121](#) for the troubleshooting steps to follow in this case.

Streaks

Looking at patterns A, B, C, G and H, you may find vertical streaks if the printer's printheads are not working correctly. Replacing the printhead for the color showing the streaks may solve the problem.

Example:

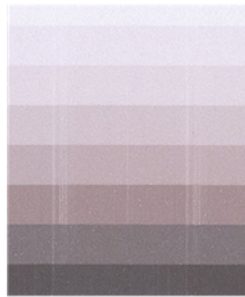

Grain

Looking at patterns A, B, and C, you may find problems in the printer's paper advance or the printheads that cause visible grain in area fills.

The following examples show this defect, the original is on the left, the printed image on the right:

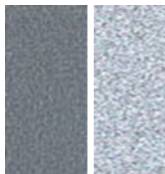

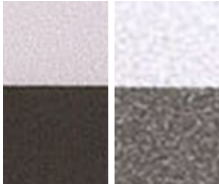

Scan or copy the diagnostic plot

There are two options for evaluating the diagnostic plot: scanning into a JPEG file, or copying onto paper. We recommend using the scan option, so that the generated file can be analyzed more easily by a remote support engineer if necessary.

If you decide to scan the plot, first adjust your computer's monitor as described in [Monitor calibration on page 155](#). Once you have scanned the diagnostic plot, remember to open the scanned file in any image viewer software and select a zoom of 100% for correct visual evaluation of patterns.

If you decide to copy, make sure that paper is loaded in the printer; the paper should be of the maximum width accepted by the printer. Ideally, the same type of paper used to print the diagnostic plot should be used for copying it.

These are the settings that you should select:

Scan

- Resolution: 600 dpi
- File type: JPG
- File size: medium
- Paper type: according to the paper used to print the diagnostic plot.

Copy

- Content type: Image

Load the diagnostic plot into the scanner input tray, making sure that the printed side of the plot is facing up. The black arrows on the diagnostic plot indicate the direction of loading. Make sure that the diagnostic plot is loaded without skew, and it is centered (that is, it covers the whole scanner area).

Once you have scanned the diagnostic plot (in case you selected the scan option), remember to open the scanned file in any image viewer software and select a zoom of 100% for correct visual evaluation of patterns.

Monitor calibration

The monitor on which the plot is going to be evaluated should ideally be calibrated. As this is not always feasible, we propose here to follow an easy procedure for adjusting the brightness and contrast of the monitor in order to see the patterns correctly.

Adjust the brightness and contrast of your monitor until you can see a difference in lightness between these two squares:



Now you are ready to check each pattern individually.

Save the diagnostic plot for future use

We recommend saving the diagnostic plot for future use.

18 Troubleshooting ink cartridge and printhead issues

Step by step instructions are provided for you to identify and resolve your issue.

Cannot insert an ink cartridge

It is important that you are using the correct type of cartridge, and that it is well placed in its slot.

1. Check that you have the correct type of cartridge (model number).
2. Check that the colored label on the cartridge is the same color as the label on the slot.
3. Check that the cartridge is correctly oriented, with the letter or letters marking the cartridge label right-side up and readable.

 **CAUTION:** Never clean inside the ink cartridge slots.

Ink cartridge status messages

There are ink cartridge status messages to alert you to an issue.

- **OK:** The cartridge is working normally, with no known problems.
- **Missing or Damaged:** There is no cartridge present, or it is not correctly connected to the printer (shown with an X on the status screen).
- **Low:** The ink level is low.
- **Out of ink:** The cartridge is empty.
- **Not genuine HP:** The cartridge is not a genuine HP cartridge.
- **Wrong slot:** The cartridge has been inserted into the wrong slot.
- **Incompatible:** The cartridge is incompatible with this printer.

Cannot insert the printhead

It is important that you are using the correct type of printhead, and that it is well placed in its slot.

1. Check that you have the correct type of printhead (model number).
2. Check that you have removed the orange protective cap from the printhead.
3. Check that the printhead is correctly oriented.
4. Check that you have correctly latched the printhead, see [Replace the printhead on page 90](#).

19 Troubleshooting data communication issues

Step by step instructions are provided for you to identify and resolve your issue.



Communication failures between computer and printer

It is important that the printer is communicating properly to the computer to be able to print.

Symptoms of a communication failure can be:

- The control-panel display does not show the **Printing** message when you have sent a document to the printer.
- Your computer displays an error message when you are trying to print.
- Your computer or printer hangs (stays idle), while communication is taking place.
- Your printed output shows random or inexplicable errors (misplaced lines, partial graphics etc.)

How to proceed:

- Ensure that you have selected the correct printer in your application, see [Printing on page 38](#).
- Ensure that the printer works correctly when printing from other applications.
- Remember that very large prints may take some time to receive, process and print.
- If the printer is connected to a network, check the printer connectivity status: the printer should have an IP address and it should match the IP address specified in the printing computer. If the addresses do not match, then configure it correctly; if the issue persists, check your network configuration.
- Try another Ethernet cable.
- If the printer is connected to a wireless network, you can request a diagnostic report from the control panel: tap the **Menu** icon , then **Settings**  > **Network** > **WiFi** > **WiFi Test Report**.
Alternatively, try moving the printer closer to the wireless router, or try connecting the printer by wired network.



Fixed IP

Set a fixed IP address for the printer from the control panel.

1. Go to the control panel and tap the **Menu** icon , then > **Settings** > **Network** > **Wi-Fi** or **Ethernet**.
2. At the bottom of the screen, tap **IPv4 / IPv6** > **Manual**, and enter the IP address, the subnet mask, and the gateway (those settings should be provided by your network administrator).

Hostname

You can use the hostname instead of the numeric IP address.

1. Go to the control panel and tap the **Menu** icon , then **Settings**  > **Network** > **Wi-Fi/Ethernet details**.
2. Take a note of the IP address and the hostname (HPXXXXXX format).
3. If your computer is running Windows, tap the **Start** button, then the **Configuration** button, then tap **Devices** > **Printers and Scanners**, then tap the printer, then **Administer** > **Properties** > **Ports** > **Configure Port**, and in the **Printer name** or **IP address** field enter the hostname.

Wired network issues

If you are unable to install the HP software for your printer, then you need to perform some checks to solve the issue.

Check that:

- All cable connections to the computer and the printer are secure.
- The network is operational and the network equipment is turned on.
- All applications, including virus protection programs, spyware protection programs, and firewalls, are not blocking the connections to the printer.
- The printer is installed on the same subnet as the computers that use the printer.

If the installation program cannot discover the printer, print the network configuration page, and enter the IP address manually in the installation program. For more information, see [Network configuration page on page 163](#).

Though it is not recommended that you assign a static IP address to the printer, you might resolve some installation problems (such as a conflict with a personal firewall) by doing so. See [Communication failures between computer and printer on page 158](#).

Network port created does not match printer IP address (Windows)

If you are using a computer running Windows, make sure that the network ports created in the printer driver match the printer's IP address.

1. Print the printer's network configuration page.
2. Click **Start**, point to **Settings**, then click **Printers** or **Printers and Faxes**.
- or -
Click **Start**, click **Control Panel**, then double-click **Printers**.
3. Right-click the **Printer** icon, click **Properties**, and then click the **Ports** tab.
4. Select the TCP/IP port for the printer, and then click **Configure Port**.
5. Compare the IP address listed in the dialog box and make sure it matches the IP address listed on the network configuration page. If the IP addresses are different, change the IP address in the dialog box to match the address on the network configuration page.



6. Click **OK** twice to save the settings and close the dialog boxes.

Wireless network issues

Step by step instructions are provided for you to identify and resolve your issue.

Wireless network troubleshooting

Check that the wireless is on, then follow the troubleshooting steps.

1. To turn on wireless, tap the **Menu** icon , then **Settings**  > **Network** > **Wi-Fi** > toggle Wi-Fi to ON.
2. Make sure that an Ethernet cable has not been connected to the printer. Connecting an Ethernet cable turns off the printer's wireless capabilities.
3. Restart components of the wireless network.

Turn off the router and the printer, and then turn them back on in this order: router first and then the printer. If you still are unable to connect, turn off the router, printer, and your computer. Sometimes, turning off the power and then turning it back on can solve a network communication issue.

4. Run the Wireless Network Test.

For wireless networking issues, run the Wireless Network Test. To print a Wireless Network Test page, tap the **Menu** icon , then **Settings**  > **Network** > **Wi-Fi** > **Wi-Fi Test Report**. If a problem is detected, the printed test report includes recommendations that could help to solve the problem.

Advanced wireless network troubleshooting

If you have tried to fix the problem and are still unable to connect to your printer to the wireless network, then there are steps you can take.

Try the following:

1. Make sure that your computer's wireless networking has been turned on. For more information, see the documentation that came with your computer.
2. If you are not using a unique network name (SSID), then it is possible that your computer could be connected to a nearby network that is not yours. The following steps can help you to determine whether your computer is connected to your network.

Windows:

- a. Click **Start**, click **Control Panel**, point to **Network Connections**, then click **View Network Status and Tasks**

- or -

Click **Start**, then **Settings**, click **Control Panel**, double-click **Network Connections**, click the **View** menu, then select **Details**.

Leave the network dialog box open while you continue to the next step.

- b. Disconnect the power cord from the wireless router. The connection status of your computer should change to **Not Connected**.

- c. Reconnect the power cord to the wireless router. The connection status should change to **Connected**.

Mac OS X:

- Click the **Wi-Fi** icon  in the menu bar at the top of the screen. From the menu that appears, you can determine if the Wi-Fi is turned on and which wireless network your computer is connected to.

 **TIP:** For more detailed information about your Wi-Fi connection, click **System Preferences** in the Dock. If the wireless connection is working correctly, a green dot appears next to the list of connections. For more information, click the **Help** button in the window.

If you are unable to get your computer connected to your network, contact the person/company that set up your network or the router manufacturer as there may be a hardware issue with your router or computer.

3. Print the printer's Wireless Configuration page (see [Network configuration page on page 163](#)). After the page has been printed, check the Network Status and URL. The Network Status is **Ready** if the printer is actively connected to a network, or **Offline** if it is not (in the latter case, run the Wireless Network Test). The URL is the network address assigned to the printer by your router; you need it to connect to the printer's Embedded Web Server.
4. If you have established that the computer and the printer both have active connections to a network, you can check whether they are on the same network by trying to access the printer's Embedded Web Server (see [Access the Embedded Web Server on page 19](#)).
5. If you cannot access the Embedded Web Server and are sure that both the computer and printer have active connections to the same network, the firewall security software could be blocking communication. Temporarily turn off any firewall security software running on your computer, and try to access the Embedded Web Server again. If you can access it, try using the printer for printing.

If you are able to access the Embedded Web Server and use your printer with the firewall turned off, you need to reconfigure your firewall settings to allow the computer and printer to communicate with each other over the network.

If you are able to access the Embedded Web Server, but are still unable to use the printer even with the firewall turned off, try enabling the firewall software to recognize the printer.

6. If you have the HP software installed, you can check the printer's status from your computer to check whether the printer is paused or offline, preventing you from using it.

Windows:

- a. Click the **Start** button, then the **Configuration** button, then tap **Devices > Printers and Scanners**.
- b. Do one of the following, depending on the printer status:
 - If the printer is **Offline**, right-click the printer, and click **Use Printer Online**.
 - If the printer is **Paused**, right-click the printer, and click **Resume Printing**.
- c. Try using the printer over the network.

Mac OS X:

- a. Click **System Preferences** in the dock, then click **Printers & Scanners**.
- b. Select the printer, then click **Print Queue**.
- c. If **Jobs Stopped** appears in the resulting window, click **Start Jobs**.

Windows:

- a. Click the **Start** button, then the **Configuration** button, then tap **Devices > Printers and Scanners**.
- b. Do one of the following, depending on the printer status:
 - If the printer is **Offline**, right-click the printer, and click **Use Printer Online**.
 - If the printer is **Paused**, right-click the printer, and click **Resume Printing**.
- c. Try using the printer over the network.

Mac OS X:

- a. Click **System Preferences** in the dock, then click **Printers & Scanners**.
 - b. Select the printer, then click **Print Queue**.
 - c. If **Jobs Stopped** appears in the resulting window, click **Start Jobs**.
7. If you install the HP software a second time, the installer may create a second version of the printer driver in your Printers or Printers and Faxes folder (Windows only). If you have difficulties printing or connecting to the printer, make sure the correct version of the Windows printer driver is set as the default.
- a. Click **Start**, point to **Settings**, then click **Printers** or **Printers and Faxes**.

- or -

Click **Start**, click **Control Panel**, then double-click **Printers**.
 - b. Right-click the **Printer** icon, and then click **Properties**, **Document Defaults**, or **Printing Preferences**.
 - c. On the **Ports** tab, look for a port in the list with a checkmark. The version of the printer driver that is connected wirelessly has **Standard TCP/IP Port** as the Port description, next to the checkmark.
 - d. Right-click the **Printer** icon for the version of the printer driver that is connected wirelessly, and click **Set as Default Printer**.
8. Try restarting the HP Network Device Support service (Windows only).
- a. Delete any print jobs currently in the print queue.
 - b. On the desktop, right-click **My Computer** or **Computer**, then click **Manage**.
 - c. Double-click **Services and Applications**, then click **Services**.
 - d. Scroll down the list of services, right-click **HP Network Devices Support**, then click **Restart**.
 - e. After the service restarts, try using the printer over the network again.

If you are able to use the printer over the network, your network setup was successful.

If you still cannot use the printer over the network, or if you have periodic problems in doing so, your firewall may be interfering, or there may be a problem with your network configuration or router. Contact the person who set up your network or the router manufacturer for help.

Add hardware addresses to a wireless access point (WAP)

MAC filtering is a security feature in which a WAP is configured with a list of MAC addresses (also called “hardware addresses”) of devices that are allowed to gain access to the network through the WAP.

If the WAP does not have the hardware address of a device attempting to access the network, the WAP denies the device access to the network. If the WAP filters MAC addresses, then the printer’s MAC address must be added to the WAP’s list of accepted MAC addresses.

1. Print the network configuration page. For more information, see [Network configuration page on page 163](#).
2. Open the WAP’s configuration utility, and add the printer’s hardware address to the list of accepted MAC addresses.

Mobile Printing issues



For issues, visit the links listed here.

See the HP website at the following link: <http://www.hp.com/go/designjetmobility> (availability varies by product, country, and region).

Also see the HP website at the following link: <http://www.hpsmart.com>.

Network configuration page

If the printer is connected to a network, you can print a network configuration page to view the network settings for the printer.

You can use the network configuration page to help troubleshoot network connectivity problems. If you need to call HP, it is often useful to print this page before calling. To print the network configuration page from the control panel: tap the **Menu** icon , then > **Tools**  > **Reports**  > **Status Reports** > **Network Configuration Report**.

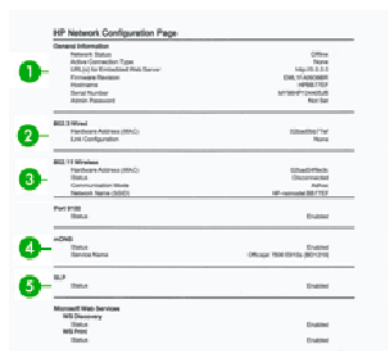

HP Network Configuration Page		
General Information		
Network Status	Offline	
Network Connection Type	None	
URL for Embedded Web Server	http://192.168.1.1	
Embedded Web Server	ON	
Hardware	HP8570Z	
Serial Number	3471200100000	
Model Password	None Set	
802.3 Wired		
Hardware Address (MAC)	080042001000	Enabled
Link Configuration		None
802.11 Wireless		
Hardware Address (MAC)	080042001000	Enabled
Status	Disconnected	
Communication Mode	adhoc	
Network Name (SSID)	HP-xxxxxx-80211G	
Port 8020		
Status	Enabled	
u2400		
Status	Enabled	
Network Name	HP-xxxxxx-80211G	
802.11		
Status	Enabled	
Managed Web Services		
Web Discovery	Enabled	
Web Print	Enabled	
Status	Enabled	

1. **General Information:** Shows information about the current status and active connection type of the network, and other information, such as the URL of the Embedded Web Server.
2. **802.3 Wired:** Shows information about the active wired network connection, such as the IP address, subnet mask, default gateway, and hardware address of the printer.

3. **802.11 Wireless:** Shows information about your wireless network connection, such as the hostname, IP address, subnet mask, default gateway, and server.
4. **Miscellaneous:** Shows information about more advanced network settings.

- **Port 9100:** The printer supports raw IP printing through TCP Port 9100. This HP-proprietary TCP/IP port on the printer is the default port for printing. It is accessed by HP software (for example, the HP Standard Port).
- **LPD:** Line Printer Daemon (LPD) refers to the protocol and programs associated with line-printer spooling services that may be installed on various TCP/IP systems.

 **NOTE:** The LPD functionality can be used with any host implementation of LPD that complies with the RFC 1179 document. The process for configuring printer spoolers, however, might differ. See your system documentation for information about configuring these systems.

- **Bonjour:** Bonjour services (which use mDNS, or Multicast Domain Name System) are typically used on small networks for IP address and name resolution (through UDP port 5353), where a conventional DNS server is not used.
- **SLP:** Service Location Protocol (SLP) is an Internet standard network protocol that provides a framework to allow networking applications to discover the existence, location, and configuration of networked services in enterprise networks. This protocol simplifies discovery and use of network resources such as printers, Web servers, fax machines, video cameras, file systems, backup devices (tape drives), databases, directories, mail servers, and calendars.
- **Microsoft Web Services:** Enable or disable the Microsoft Web Services Dynamic Discovery (WS Discovery) protocols or Microsoft Web Services for Devices (WSD) Print services supported on the printer. Disable unused print services to prevent access through those services.

 **NOTE:** For more information about WS Discovery and WSD Print, visit the Microsoft website at the following link: <http://www.microsoft.com/>.

- **SNMP:** SNMP (Simple Network Management Protocol) is used by network management applications for device management. The printer supports SNMPv1 protocol on IP networks.
 - **WINS:** If you have a Dynamic Host Configuration Protocol (DHCP) server on your network, the printer automatically obtains its IP address from that server and registers its name with any RFC 1001 and 1002-compliant dynamic name services as long as a WINS server IP address has been specified.
5. **Connected PC(s):** Lists the computers connected to this printer, as well as the last time these computers accessed the printer.

20 Troubleshooting general printer issues

Step by step instructions are provided for you to identify and resolve your issue.

Printer does not start

You may have an electrical power problem. If there is no activity at all from the printer and the control panel does not respond, check that the power cord is connected correctly and that there is power available at the socket.

- If the printer does not start (the control panel is blank), hold down the **Power** key for a few seconds and check whether the power LED turns orange while the key is held down.
- If you see no orange light, no power is reaching the printer; check that the power cord is correctly plugged in. If the problem persists, call HP Support (see [HP Customer Care on page 173](#)) and explain that you have a problem with the power supply.
- If you see the orange light, wait for the printer to check if it makes a beeping sound:
 - Three beeps means an electronic problem; call HP Support and explain.

Printer does not print

If all is in order (paper loaded, all ink components installed and no file errors), there are still reasons why a file you have sent from your computer may not start printing when expected:

- You may not have installed in your computer the correct driver for your printer.
- If you are printing on a sheet, you must specify **Automatic** or **Sheet** or **Tray** as the paper source in your printer driver.
- Check the complexity of the job, very large prints may take some time to receive, process and print.
- You may be experiencing unusual electromagnetic phenomena, such as strong electromagnetic fields or severe electrical disturbances, which can cause the printer to behave strangely or even stop working. In this case, turn off the printer using the **Power** key at the back and unplug the power cord, wait until the electromagnetic environment has returned to normal, then turn it on again. If you still experience problems, contact your customer service representative.

Printer seems slow

Here are some possible explanations:

- Did you set the print-quality to **Best** or **Maximum detail**? Best-quality and maximum detail prints take longer.
- Did you specify the correct paper type when loading the paper? Some paper types require more time for printing; for example, photo and coated papers require more drying time between passes. To find out the printer's current paper type setting, see [View information about the paper on page 35](#).

- If your printer is connected by network, check that all components used in the network (network interface cards, hubs, routers, switches, cables) are capable of high-speed operation. Is there a lot of traffic from other devices on the network?
- Did you specify **Extended** drying time in the control panel? Try changing the drying time to **Optimal**.
- If your printer is connected by Wi-Fi, switch to a wired network.

Control panel is frozen

If the control panel displays a fixed image and you are unable to use it, power cycle your printer.

- Turn off the printer and unplug the power cord from it.
- Wait 30 seconds.
- Plug the power cord into the printer again and turn the printer on.
- Check the functionality of the printer.

If the problem persists, call HP support. See [HP Customer Care on page 173](#).

Cannot access the Embedded Web Server

If you are using a proxy server, try bypassing the server and accessing the Embedded Web Server directly.

Before proceeding, if you have not done so already, please read: [Access the Embedded Web Server on page 19](#).

- In Microsoft Edge for Windows, go to **Tools > Internet Options > Connections > LAN Settings**, and check the **Bypass proxy server for local addresses** box. Alternatively, for more precise control, click the **Advanced** button and add the printer's IP address to the list of exceptions, for which the proxy server is not used.
- In Safari for Mac OS X, go to **Safari > Preferences > Advanced** and click the **Proxies: Change Settings** button. Add the printer's IP address or its domain name to the list of exceptions, for which the proxy server is not used, in the bypass proxy settings for the **Hosts & Domains** field.



If you still cannot connect, switch the printer off and back on with the **Power** key on the control panel.

Restore factory defaults and settings

If you disabled any functions or changed some settings and want to change them back, you can restore the printer to the original factory settings or network settings.

Defaults

Restore the printer to the original factory defaults.

1. From the control panel, tap **Menu**  > **Tools**  > **Maintenance**  > **Restore Settings**, then select the appropriate reset option: **Restore Network Settings**, **Restore User Settings**, **Restore User Data**, or **Restore All Factory Defaults**.

2. From the Embedded Web Server, open the **General** tab, then **Restore Default Settings**, then select the appropriate reset option: **Restore Network Settings** or **Restore All Factory Defaults**.
3. **Restore All Factory Defaults.** Tap **Restore** to reset all printer settings. All configured settings in the printer will be deleted and the original factory settings will be restored, including all administrator passwords for the printer, network configurations, any stored jobs (if available), HP workpath licenses (if available), contact entries (for scan and fax), and web services account information.

Alerts

Your printer can report errors or alerts in different ways.

- **Errors:** Mainly alerting you to the fact that the printer is unable to work normally. However, in the printer driver, errors can also alert you to conditions that could ruin the print, such as clipping, even if the printer is able to print.
- **Warnings:** Alert you when the printer needs attention either for an adjustment, such as a calibration or for a possible unprintable situation, such as a preventive maintenance or low ink.

There are four different alerts communicators within your printer's system:

- **Control-panel display:** The control panel shows only the most relevant alert at a time. In the case of a warning, it disappears after a timeout. There are permanent alerts, such as "ink cartridge low on ink", that reappear when the printer becomes idle and there is not another more severe alert.
- **Embedded Web Server:** The upper-right corner of the Embedded Web Server window shows the printer status. If there is an alert in the printer, the status shows the alert text.
- **Print queue:** The print queue shows alerts. The driver warns about job configuration settings that may produce a problem in the final output. If the printer is not ready to print, it displays a warning.

By default, error alerts (critical alerts) are always displayed and warning alerts (non-critical alerts) as displayed only when you are printing. If alerts are enabled and there is a problem that prevents a job from completing, you see a pop-up window, which explains the reason for the problem. Follow the instructions to achieve your required result.



NOTE: There are environments that do not support bidirectional communication. In those cases, alerts do not reach the job owner.

21 Control-panel error messages

Printer issues appear in the control panel automatically along with the recommendation of how to fix them.

Text messages and numerical error codes

Error messages indicate that there is a printer error that needs attention. When they appear, follow the advice in the Recommendation column.

If you see an error message that does not appear here, and you feel in doubt about the correct response, or if the recommended action does not seem to solve the problem, contact HP Support. See [Contact HP Support on page 175](#).

Table 21-1 Text messages

Message	Recommendation
Cartridge low	The indicated cartridges are low. You do not have to replace the cartridge(s) now. HP recommends you have a replacement available for when the cartridge is depleted and will need to be replaced.
Cartridge very low	The indicated cartridges are very low and will be depleted soon. While you do not have to replace the cartridges now, HP recommends you have a replacement available for when cartridges are depleted and will need to be replaced.
Cartridges depleted	The indicated cartridges are depleted. Replace these cartridges.
Maintenance kit 1 required	Contact HP Support. See Contact HP Support on page 175 .
Maintenance kit 2 required	Contact HP Support. See Contact HP Support on page 175 .
Cartridge Problem	Insert cartridges of the correct color as needed. See Replace an ink cartridge on page 86 .
Carriage jam	See Roll has jammed on page 108 or Tray has jammed (only HP DesignJet T850) on page 109 or Tray has jammed (HP DesignJet T950) on page 110 .
The width of the paper is smaller than the minimum size supported by the selected media source. Loading canceled.	Remove the paper and load paper of the correct size.
Loaded paper is too wide. Manual unload required.	Remove the paper manually and load paper of the correct size.
The paper is too far from the lateral load line. Try loading the paper again.	Remove and reload the paper.
Please manually unload roll paper and try again.	Rewind the roll manually.
The currently loaded paper has too much skew and cannot be corrected automatically. Tap Remove , and then load the paper again.	Remove and reload the paper.

Table 21-1 Text messages (continued)

Message	Recommendation
The roll is out of paper, and the current job has been canceled. Load another roll, and then send the job again.	Load a new roll.
You are printing a multipage job. Load another sheet to continue printing or cancel the job.	Load another single sheet.
Tray is out of paper. Load paper in the tray and press OK to continue printing or cancel the job.	Load paper into the tray.
End of roll has been reached. It is not possible to load the roll.	Load a new roll.
Missing or failed printhead.	Remove and reinsert the same printhead, or try cleaning the electrical connections. If necessary, insert a new printhead. See Replace the printhead on page 90 . NOTE: The error message does not permit returning to the home screen to start the printhead replacement. Instead, press Show more .
Refilled or depleted cartridge detected	Check the cartridge.
Used cartridges might not have enough ink to complete start-up. Open ink door to replace the cartridges.	A new printhead has been inserted without a new set of ink cartridges. Replace the cartridges not marked as new. See Replace an ink cartridge on page 86 .

Reading a system error code

System error codes explain what action should be taken to resolve the problem. They are defined in two ways: D0XX-YYZZ, which explains which component or system is failing, or xx.xx.xx.xx. Both formats indicate the course of action to be taken.

The first format is explained in the following table. The second format (xx.xx.xx.xx) occurs in response to internal firmware failures. In this case, you should restart the printer, then ensure that you have the latest firmware version: updating it may solve the problem. If the problem persists, contact your service representative. Some examples of these errors are F0.01.01.02, F0.01.04.07, F0.01.01.04 or F0.01.01.01.

For System Errors in format D0XX-YYZZ, the different parts of the code have the following meanings:

- D: Device information in which the failure has been detected.
- XX: Subsystem in which the failure has been detected (see the subsystem error codes table)
- YY: Service part in which the failure has been detected.
- ZZ: Indicates the cause of error as identified by self-diagnostics; see the next section for more details.

Values of D (Device)

Value Subsystem

0 Printer

1 Accessories

8 Internal printer firmware error*

*Errors starting with 8 (D=8) are internal firmware issues (for example, 86B0-1A7E-0000). If an error of this kind appears, there is probably an issue in the firmware that will be solved in a future release. These errors are not documented for this reason. If one of these errors appears, check whether the latest firmware is installed and install it if needed.

Table 21-2 Values of XX (subsystem)

Value	Subsystem
01	Main PCA
04	Print Bundle PCA
09	Scanner
21	Service Station
26	Ink supply station
27	Printhead
41	Carriage PCA
42	Carriage Motor
43	Pick Motor
44	Feed Motor
45	Rewinder Motor
59	NVM
85	Feed Index PCA
87	Encoder

For system errors in the XX.YY.XX.XX format, YY indicates the subsystem.

Table 21-3

Value	YY
01	System
02	Security
03	Connectivity
04	Front panel firmware
31	Job management

Table 21-4 Numerical error codes

Error code	Recommendation
0009-0101	Scanner issue. To continue using the scanner, restart the printer. If the problem persists, call your support representative.

Table 21-4 Numerical error codes (continued)

Error code	Recommendation
0009-0301	Scanner issue. To continue using the scanner, restart the printer. If the problem persists, call your support representative.
0009-0401	Scanner issue. To continue using the scanner, restart the printer. If the problem persists, call your support representative.
0009-0501	Scanner issue. To continue using the scanner, restart the printer. If the problem persists, call your support representative.
0009-0259	Scanner Motor error. There may be a paper or carriage jam. Check and clear the paper path if necessary and restart the printer.
0021-0017	Service station error. There may be a paper or carriage jam. Check and clear the paper path if necessary and restart the printer.
0021-0060	Service station error. There may be a paper or carriage jam. Check and clear the paper path if necessary and restart the printer.
0026-0061	ISS Pump error. Call your support representative.
0042-0059	Carriage Motor error. There may be a paper or carriage jam. Check and clear the paper path if necessary and restart the printer.
0042-0060	Carriage Motor error. There may be a paper or carriage jam. Check and clear the paper path if necessary and restart the printer.
0042-0161	Carriage Motor error. Restart the printer. If the problem persists, call your support representative.
0043-0059	Pick motor error. There may be a paper or carriage jam. Check and clear the paper path if necessary and restart the printer.
0043-0060	Pick motor error. There may be a paper or carriage jam. Check and clear the paper path if necessary and restart the printer.
0044-0059	Feed motor error. There may be a paper or carriage jam. Check and clear the paper path if necessary and restart the printer.
0044-0060	Feed motor error. There may be a paper or carriage jam. Check and clear the paper path if necessary and restart the printer.
0045-0060	Rewinder motor error. There may be a paper or carriage jam. Check and clear the paper path if necessary and restart the printer.
0721-0078	PMK maintenance needed. Call your support representative.
0942-0188	Carriage Motor error. There may be a paper or carriage jam. Check and clear the paper path if necessary and restart the printer.
0955-0050	Line sensor error. Call your support representative.
F0.01.01.01	Internal FW error. Make sure that the printer firmware version is up to date and restart the printer.

Table 21-4 Numerical error codes (continued)

Error code	Recommendation
F0.01.01.02	Internal FW error. Make sure that the printer firmware version is up to date and restart the printer.
F0.01.01.04	Internal FW error. Make sure that the printer firmware version is up to date and restart the printer.
F0.01.01.07	Internal FW error. Make sure that the printer firmware version is up to date and restart the printer.
F0.01.04.07	Internal FW error. Make sure that the printer firmware version is up to date and restart the printer.
F0.01.01.06	Make sure that the printer firmware version is up to date and restart the printer.
F0.01.04.03	Make sure that the printer firmware version is up to date and restart the printer.
F0.01.03.01	Make sure that the printer firmware version is up to date and restart the printer.
F0.01.03.04	Make sure that the printer firmware version is up to date and restart the printer.
8XXX-XXXX	Internal FW error. Make sure that the printer firmware version is up to date and restart the printer.

22 HP Customer Care

HP Customer Care offers award-winning support to ensure you get the most from your HP DesignJet, providing comprehensive, proven support expertise and new technologies to give you unique end-to-end support.

Introduction

Services include setup and installation, troubleshooting tools, warranty upgrades, repair and exchange services, phone and Web support, software updates and self-maintenance services.

To find out more about HP Customer Care, see [Contact HP Support on page 175](#).

To register your warranty, visit the HP website at the following link: <https://eoi.hpcloud.hp.com/login>.

HP Professional Services

Enjoy a world of dedicated services and resources to ensure you always get the best performance from your HP DesignJet printers and solutions.

HP Support Center

Join the HP community at the HP Support Center, your large-format printing community, for 24×7 access to support.

- Multimedia tutorials
- Step-by-step how-to guides
- Downloads: the latest printer firmware, drivers, software, paper presets, etc.
- Technical support: online troubleshooting, customer care contacts and more
- Workflows and detailed advice for completing various printing tasks from particular software applications
- Forums for direct contact with the experts, both HP and your colleagues
- Warranty tracking online, for your peace of mind
- Latest product information: printers, supplies, accessories, software, etc.
- Supplies Center for all you need to know about ink and paper

The HP Support Center can be found on the HP website at the following link (depending on printer model):

- **HP DesignJet T850:** <https://www.hp.com/go/DesignJetT850/support>
- **HP DesignJet T850 MFP:** <https://www.hp.com/go/DesignJetT850MFP/support>
- **HP DesignJet T950:** <https://www.hp.com/go/DesignJetT950/support>

- **HP DesignJet T950 MFP:** <https://www.hp.com/go/DesignJetT950MFP/support>

By customizing your registration for the products you have purchased and your type of business, and by setting your communication preferences, you decide the information you need.

Download printer software

Be sure to follow the software installation instructions.

Install the printer software from the HP website at the following link (depending on printer model):

- **HP DesignJet T850:** <https://www.hp.com/go/DesignJetT850/software>
- **HP DesignJet T850 MFP:** <https://www.hp.com/go/DesignJetT850MFP/software>
- **HP DesignJet T950:** <https://www.hp.com/go/DesignJetT950/software>
- **HP DesignJet T950 MFP:** <https://www.hp.com/go/DesignJetT950MFP/software>

HP Care Packs and Warranty Extensions

HP Care Packs and Warranty Extensions allow you to extend your printer's warranty beyond the standard period.

They include remote support. On-site service is also provided if necessary, with two alternative response-time options:

- Next business day
- Same business day, within four hours (may not be available in all countries)

There is an HP Installation service that unpacks, sets up, and connects the printer for you.

For more information on HP Care Packs, visit the HP website at the following link:

<http://cpc.ext.hp.com/portal/site/cpc>.

Customer Self Repair

HP's Customer Self Repair program offers our customers the fastest service under either warranty or contract. It enables HP to ship replacement parts directly to you (the end user) so that you can replace them.

Using this program, you can replace parts at your own convenience.

Convenient, easy to use

- An HP Support Specialist will diagnose and assess whether a replacement part is required to address a defective hardware component.
- Replacement parts are express-shipped; most in-stock parts are shipped the very same day you contact HP.
- Available for most HP products currently under warranty or contract.
- Available in most countries.

For more information about Customer Self Repair, visit the HP website at the following link:

<http://www.hp.com/go/selfrepair>.

Contact HP Support

HP Virtual Assistant is there to provide you with support at any time day or night.



You can access the HP Virtual Assistant for your printer from the HP website at the following link:
<https://www.hp.com/go/DesignJet/VA>.

HP Support is also available to you by telephone. What to do before you call:

- Review the troubleshooting suggestions in this guide.
- Review the relevant driver documentation.
- If you have installed third-party software drivers and RIPs, see their documentation.
- If you call one of the HP offices, please have the following information available to help us answer your questions more quickly:
 - The product you are using (the product number and the serial number, found on the label at the back of the product)
 - If there is an error code on the control panel, note it down; see [Text messages and numerical error codes on page 168](#)
 - The computer you are using
 - Any special equipment or software you are using (for example, spoolers, networks, switch-boxes, modems or special software drivers)
 - The type of interface used on your product (USB, network, or Wi-Fi)
 - The software and driver name and version number that you are currently using
 - The Printer Service information:
 - From the Embedded Web Server:

In a Web browser, enter your printer's IP address to access the Embedded Web Server. To access the printer's service information:

Tap **Support Tools** > **Service Support** > **Service Information** > , then tap the **Download** button

Reports and **Pages Shown** and **Service Information** will be automatically checked.

Tap the **Download** button. Wait until the printer has finished generating the report file.



NOTE: When you access these pages, the printer asks you to sign in with the PIN. See [Access the Embedded Web Server on page 19](#).

23 Printer specifications

Reference lists of physical, technical, ecological, etc. specifications for your printer.

Functional specifications

Your printer is designed to deliver CAD / construction drawings as well as high quality graphics.

Table 23-1 HP ink supplies

Description	Specification
Printhead	One printhead
Ink cartridges	Cartridges containing 130 ml of ink: black, yellow, magenta, and cyan
	Cartridges containing 300 ml of ink: black, yellow, magenta, and cyan

Table 23-2 Paper sizes

Description	Minimum	Maximum
Roll width	368 mm (14.5 in)	914 mm (36 in)
Roll length	N/A	HP DesignJet T850: 46 m (150 feet) HP DesignJet T950: 91 m (300 feet)
Roll diameter	N/A	HP DesignJet T850: 100 mm (3.9 in) HP DesignJet T950: 140 mm (5.5 in)
Roll weight	N/A	HP DesignJet T850: 6 kg (13.2 lb) HP DesignJet T950: 13 kg (28.6 lb)
Sheet width	210 mm (8.27 in)	914 mm (36 in)
Sheet length	279 mm (11 in)	1676 mm (66 in)
Paper thickness	N/A	0.3 mm (0.01 in)
Paper weight - roll/manual sheet	60 g/m ²	280 g/m ²
Paper weight - multi-sheet tray	HP DesignJet T850: 60 g/m ²	HP DesignJet T850: 220 g/m ²
	HP DesignJet T950: 64 g/m ²	HP DesignJet T950: 250 g/m ²

Table 23-3 Printing resolutions

Print quality	Maximum detail	Rendering resolution (ppi)	Printing resolution (dpi)
Best (glossy paper*)	On	1200 × 1200	2400 × 1200
	Off	600 × 600	1200 × 1200

Table 23-3 Printing resolutions (continued)

Print quality	Maximum detail	Rendering resolution (ppi)	Printing resolution (dpi)
Best (other papers)	Off	600 × 600	1200 × 1200
Normal	Off	600 × 600	1200 × 1200
Fast	Off	600 × 600	1200 × 1200
Econofast	Off	600 × 600	1200 × 1200

* For a list of supported glossy papers, see [Order paper on page 101](#).

Table 23-4 Margins

Description	Specification
Top left and right margins	5 mm (0.2 in)
Bottom margin	17 mm (0.67 in) (manual sheet)

Table 23-5 Mechanical accuracy

Specifications
±0.1% of the specified vector length or ±0.2 mm (whichever is greater) at 23°C (73°F), 50-60% relative humidity, on E/AO printing material in Best or Normal mode with HP Heavyweight Coated Paper roll feed.

Table 23-6 Graphic languages supported

HP DesignJet	Languages
HP DesignJet T850/ T950	HP PCL3GUI, HP-GL/2, PDF (on HP DesignJet T950 and HP DesignJet T850 MFP units)

Physical specifications

Printer models have both common and distinct specifications.

Table 23-7 Printer physical specifications

Specification	HP DesignJet T850	HP DesignJet T850MFP	HP DesignJet T950	HP DesignJet T950MFP
Weight	47 kg (104.5 lb) (w/o paper roll)	60 kg (130.1 lb) (w/o paper roll)	56 kg (124.8 lb) (w/o paper roll)	71 kg (156.5 lb) (w/o paper roll)
Width	1407 mm (55.4 in)	1407 mm (55.4 in)	1407 mm (55.4 in)	1407 mm (55.4 in)
Depth	914 mm (36 in) (output bin extended)	914 mm (36 in) (output bin extended)	988 mm (38.9 in) (soft stacker extended)	988 mm (38.9 in) (soft stacker extended)
	701 mm (27.6 in) (output bin closed)	701 mm (27.6 in) (output bin closed)	720 mm (28.3 in) (soft stacker closed)	720 mm (28.3 in) (soft stacker closed)
Height	967 mm (38 in)	967 mm (38.1 in)	967 mm (38 in)	967 mm (38.1 in)

Memory specifications

Your printer has 1 GB of memory.

Table 23-8 Memory specifications

Printer	Memory
HP DesignJet T850/T950	1 GB

Power specifications

Use the electrical cord supplied with the printer and the power supply voltage specified on the label. Avoid overloading the printer's electrical outlet with multiple devices.

Table 23-9 Printer power specifications

Type:	Values:
Source	100–240 V ac \pm 10%, auto-ranging
Frequency	50/60 Hz
Maximum current	1200 mA
Average consumption	35 W

Ecological specifications

This product complies with the WEEE Directive 2012/19/EU and RoHS Directive 2011/65/EU.

To determine the ENERGY STAR and EPEAT registration status of these product models, check your model at the following links: <http://www.epeat.net> and <http://www.energystar.gov/productfinder> or see the HP website at the following link: <https://www.hp.com/us-en/hp-information/sustainable-impact/document-reports.html>.

Inks are UL ECOLOGO® certified. For more information, visit the following link: <http://www.spot.ul.com/main-app/products/catalog/>

Printer models made with a minimum of 35% post-consumer recycled plastic by total plastic weight.

Free, convenient HP ink cartridge recycling with HP Planet Partners program. Program availability varies. Please check the HP website at the following link for details: <http://www.hp.com/recycle>.

The new scheduler feature enables to significantly save energy when the printer is idle.

For every page you print, HP protects, restores and manages forests. HP works collaboratively with our partners including WWF and Conservation International to manage, restore, and protect forests in many countries around the world. With HP, every print—regardless of paper brand—is addressed through HP's Forest Positive Framework to counteract risks of deforestation. To learn more visit the HP website at the following link: <http://hp.com/forestfirst>

Environmental specifications

Recommended operating and storage temperature and humidity.

Table 23-10 Printer environmental specifications

Type:	Values:
Operating temperature	5 to 40 degree Celsius (41 to 104 degree Fahrenheit)
Recommended operating temperature	15 to 35 degree Celsius (59 to 95 degree Fahrenheit), depending on paper type
Storage temperature	-25 to 55 degree Celsius (-13 to 131 degree Fahrenheit)
Recommended operating humidity	20 to 80% RH, depending on paper type
Storage humidity	0 to 95% RH
Maximum altitude when printing	3000 m (9843 ft)

Acoustic specifications

Declared noise emission levels for the HP DesignJet T850/T950 Printer Series. Sound pressure levels at bystander positions and sound power levels measured per ISO 7779.

Table 23-11 Printer acoustic specifications

Description	Specification
Idle sound power	< 3.4 B (A)
Operating sound power	5.8 B (A)
Idle sound pressure	< 16 dB (A)
Operating sound pressure	42 dB (A)

Glossary

AirPrint

Apple technology that helps you create full-quality printed output without the need to download or install drivers.

Bonjour

Apple Computer's trade name for its implementation of the IETF Zeroconf specification framework, a computer network technology used in Apple's Mac OS X from version 10.2 onwards. It is used to discover services available on a local area network. It was originally known as Rendezvous.

Color accuracy

The ability to print colors that match the original image as closely as possible, bearing in mind that all devices have a limited color gamut and may not be physically capable of matching certain colors precisely.

Color consistency

The ability to print the same colors from a particular print job from print to print and from printer to printer.

Color model

A system of representing colors by numbers, such as RGB or CMYK.

Color space

A color model in which each color is represented by a specific set of numbers. Many different color spaces can use the same color model: for instance, monitors generally use the RGB color model, but they have different color spaces, because a particular set of RGB numbers results in different colors on different monitors.

Cutter

A printer component that slides back and forth across the platen to cut the paper.

ESD

ElectroStatic Discharge. Static electricity is common in daily life. It is the spark when touching the car door, or the cling of clothing. Although controlled static electricity has some useful applications, uncontrolled electrostatic discharges are one of the main hazards to electronic products. Therefore, to prevent damage some precautions are needed when setting up the printer, or handling ESD sensitive devices. This type of damage may reduce the life expectancy of the device. One way to minimize uncontrolled ESDs, and therefore reduce this type of damage is by touching any exposed grounded part of the printer (mainly metal parts) before handling ESD sensitive devices (such as the printhead or ink cartridges). Additionally, to reduce the generation of electrostatic charge in your body try to avoid working in a carpeted area, and keep your body movements to a minimum when handling ESD sensitive devices. Also, avoid working in low humidity environments.

Ethernet

A popular computer networking technology for local area networks.

Fast Ethernet

An Ethernet network capable of transferring data at up to 100,000,000 bits/second. Fast Ethernet interfaces are capable of negotiating slower speeds when required for compatibility with older Ethernet devices.

Firmware

Software that controls your printer's functionality and is stored semi-permanently in the printer (it can be updated).

Gamut

The range of colors and density values reproducible on an output device, such as a printer or monitor.

HP RTL

HP Raster Transfer Language: a language defined by HP to describe raster (bitmap) graphics.

HP-GL/2

HP Graphics Language 2: a language defined by HP to describe vector graphics.

I/O

Input/Output: this term describes the passing of data between one device and another.

ICC

The International Color Consortium, a group of companies that have agreed on a common standard for color profiles.

Ink cartridge

A removable printer component that stores ink of a particular color and provides it to the printhead.

IP address

May mean an IPv4 address (most likely) or an IPv6 address.

IPv4 address

A unique identifier that identifies a particular node on an IPv4 network. An IPv4 address consists of four integers separated by full stops. Most networks in the world use IPv4 addresses.

IPv6 address

A unique identifier that identifies a particular node on an IPv6 network. An IPv6 address consists of up to 8 groups of hexadecimal digits separated by colons. Each group contains up to 4 hexadecimal digits. Only a few new networks in the world use IPv6 addresses.

LED

Light-Emitting Diode: a semiconductor device that emits light when electrically stimulated.

MAC address

Media Access Control address: a unique identifier used to identify a particular device on a network. It is a lower-level identifier than the IP address. Thus, a device may have both a MAC address and an IP address.

Network

A network is a set of connections that pass data between computers and devices. Every device is able to communicate with every other device in the same network. This allows data to be moved between computers and devices, and allows devices such as printers to be shared between many computers.

Nozzle

One of many tiny holes in a printhead through which ink is deposited onto the paper.

Paper

A thin, flat material made to be written or printed on; most commonly made from fibers of some kind which are pulped, dried and pressed.

Platen

The flat surface within the printer over which the paper passes while it is being printed on.

Printer driver

Software that converts a print job in a generalized format into data suitable for a particular printer.

Printhead

A removable printer component that takes ink of one or more colors from the corresponding ink cartridge(s) and deposits it on the paper, through a cluster of nozzles.

Spindle

A rod that supports a roll of paper while it is being used for printing.

TCP/IP

Transmission Control Protocol/Internet Protocol: the communications protocols on which the Internet is based.

USB

Universal Serial Bus: a standard serial bus designed to connect devices to computers. Your printer supports Hi-Speed USB (sometimes called USB 2.0).

USB host port

A rectangular USB socket such as those on found on computers. A printer can control USB devices that are connected to such a port.

WiFi

This term is used for any wireless local area network products that are based on the Institute of Electrical and Electronics Engineers' (IEEE) 802.11 standards.

Index

A

- accessibility 19
- accessories
 - order 100, 101
- acoustic specifications 179
- alerts
 - errors 167
 - warnings 167
- automatic firmware update,
 - configure 20

B

- bin
 - output problems 116
- black and white 43
- brightness in control panel 22

C

- calibration
 - scanner 97
- care of the printer 88
- clean the encoder strip 94
- clean the platen 126, 127
- clean the printer 88
- clipped at bottom 129
- clipped image 129
- color
 - fading 129
 - inaccurate 128
- computer communication
 - printer/computer communications
 - issues 158
- configure firewall settings 23
 - change options 24
 - change the priority of rules 24
 - create a firewall rule 24
 - creating and using rules 24
 - limitations 24
 - reset network settings 25
 - reset settings 24
- connect the printer
 - choose a method 15
 - set up your device 18
 - to your network 18
- connect the printer mac os x
 - add your printer 18

- control panel 9
 - accessibility 19
 - brightness 22
 - frozen 166
 - language 19
- control panel option
 - advance 37
 - advance button and cut button 37
 - align printhead 90
 - calibrate ready paper 94
 - clean printhead 89
 - cut 37
 - display brightness 22
 - enable cutter 36
 - print diagnostic image 88, 89
 - replace printhead 90
 - reset ready paper 95
 - select drying time 36
 - select language 19
 - unload roll 29
- copy quick set 67
- copy settings 68
- copying 66
- Customer Care 173
- Customer Self Repair 174
- cutter
 - on/off 36

D

- download printer software 174
- draft printing 42
- driver preferences 20
- drying time
 - change 36

E

- ecological specifications 178
- economize
 - on ink 42
 - on paper 42
- Embedded Web Server
 - access 19
 - cannot access 166
 - language 20
- energy-conservation settings 20
 - set scheduled on/off time 21

- set the shutdown mode
 - setting 21
- set the sleep mode setting 20
- environmental specifications 178
- error messages 168

F

- fading colors 129
- features of printer 5
- firmware update
 - configure automatic 20
- frozen control panel 166
- functional specifications 176

G

- graphic languages 176
- gray shades 43
- grayscale 43

H

- hard disk specification 178
- HP app 38
- HP Care Packs 174
- HP Customer Care 173
- HP Support 175
- HP Support Center 173

I

- image problems
 - clipped at bottom 129
 - clipped image 129
 - missing objects 130
- ink
 - economical use of 42
- ink bottle
 - order 100
- ink cartridge
 - about 85
 - cannot insert 157
 - memory chip 85
 - order 100
 - replace 86
 - specification 176
 - status 86
 - status messages 157
- ink cartridge; usage information 85

ink handling 3
IP address 19
 static 158
 use hostname 159

L

language 19
load paper
 general advice 26
 roll cannot load 104
 roll into printer 28
 roll onto a spindle 26
 sheet cannot load 104
 sheet cannot load from tray
 T850 105
 single sheet 31
 use the pocket T950 35
 use the stacker T950 32
 use the tray T850 29
 use the tray T950 30

M

maintenance kits 99
margins 40
 specification 176
mechanical accuracy 176
mechanical hazard 3
memory specifications 178
misaligned colors 123
mobile printing 13, 45
 print 13, 45
 troubleshooting 163
Mobile specifications 48
models, printer 5
monitor
 calibrate 155
move or store the printer 98

N

network
 configuration page 163
network folder
 cannot access 131
 configure 58
network settings 22
network troubleshooting,
 wired 159

O

order
 accessories 100, 101
 ink cartridges 100
 paper 100, 101

printhead 100

P

paper
 advance 37
 advance button and cut
 button 37
 change from default to regular
 bin style configuration 116
 cut 37
 cut after printing 119
 Cut-sheet doesn't enter
 basket 108
 economical use of 42
 incorrect out of paper 116
 jam due to cut strip 115
 loading error messages 105
 maintenance 36
 mismatch 108
 not cut well 119
 output problems in bin 116
 print on loaded paper 41, 107
 printed on wrong paper 107
 retained by printer 119
 roll has jammed 108
 scanner does not load
 original 120
 select type 41
 sheet jammed 112
 sizes (max and min) 176
 tray has jammed T850 109
 tray has jammed T950 110
 view information 35
paper types 100, 101
physical specifications 177
platen cleaning 126, 127
power
 on/off 9
power specifications 178
preferences, Windows driver 20
print from mobile 13, 45
print from usb 43
print quality
 select 38
print quality diagnostic report 88,
 89
print-quality problems
 black ink comes off 127
 blurred lines 124
 blurry or grainy image 125
 different colored vertical
 lines 128
 discontinuous lines 123

edges darker than
 expected 128
edges stepped or not
 sharp 127
general 121
horizontal lines 121
inaccurate colors 128
inaccurate line length 124
ink marks 126
misaligned colors 123
paper not flat 125
scratching 126
scuffing 126
stepped or jagged lines 122
thick, thin, or missing lines 122
white spots 128

printer
 does not print 165
 does not start 165
 download software 174
 front view T850 6
 front view T950 7
 main features 5
 models 5
 rear view 7
 solutions 11
 status 88
printhead
 about 87
 cannot insert 157
 order 100
 specification 176
printhead cleaner
 specification 176
printing grayscale 43
printing resolutions 176

Q

quick sets 50

R

replace an ink cartridge 86
replace printhead 90
reports 13
rescale a print 41
restore factory
 defaults 166
roll paper
 unload 29

S

safe mode 87
safety precautions 1

- scale a print 41
- scan quick set 53
- scan to network folder using widget 64
- scan-quality problems
 - color differences between scanbars 138
 - color fringing 141
 - completely wrong colors 147
 - damaged original 147
 - down-scaling 149
 - edge detection 149
 - flare from glossy originals 143
 - ghosting 148
 - grain in area fills 137
 - inaccurate colors 140
 - light-colored area fills missing 136
 - line discontinuities 135
 - out of focus 144
 - paper advance 145
 - random vertical lines 134
 - shadow/highlight clipping 142
 - too much skew 150
 - variable line thickness 140
 - vertical black band 30 cm wide 146
 - vertical distortion 148
 - vertical lines between scanbars 139
 - vertical red/green bands 143
 - vibration effect 143
 - wrinkles or folds 135
- scanner
 - calibration 97
 - can't access network folder 131
 - clean scanbars 95
 - diagnostic plot 151
 - original reloaded 132
 - slow scan 131
- scanning 50
- scratched prints 126
- scuffed prints 126
- settings
 - copy 68
- sheet paper
 - unload 32
- slow printing 165
- software
 - download 174
 - install (Mac OS X) 18
 - install (Windows) 18
 - update 99
- solutions 11
- specifications
 - acoustic 179
 - ecological 178
 - environmental 178
 - functional 176
 - graphic languages 176
 - hard disk 178
 - ink supplies 176
 - margins 176
 - mechanical accuracy 176
 - memory 178
 - paper size 176
 - physical 177
 - power 178
 - printing resolutions 176
- spindle 101
- statistics
 - ink cartridge 86
- support services
 - HP Care Packs 174
 - HP Customer Care 173
 - HP Support 175
 - HP Support Center 173
 - warranty extensions 174

T

- telephone number 175
- tubes
 - cannot connect 93, 120

U

- unload paper
 - roll 29
 - sheet 32
- usage information stored in cartridge 85
- using this guide 4
- using Wi-Fi direct
 - change connection method 44
 - turn on 44
 - with mobile that doesn't support 45
 - with mobile that supports 44

W

- warranty extensions 174