



# Maintenance and Service Guide

## HP Envy 13 Laptop PC

*IMPORTANT! This document is intended for HP authorized service providers only.*

© Copyright 2020 HP Development Company, L.P.

AMD, Athlon, Ryzen, Radeon, and Radeon Vega are trademarks of Advanced Micro Devices, Inc. Bluetooth is a trademark owned by its proprietor and used by HP Inc. under license. Chrome is a trademark of Google LLC. Intel, Celeron, Core, Pentium, Thunderbolt, and XMM are trademarks of Intel Corporation or its subsidiaries in the U.S. and/or other countries. NVIDIA, GeForce, and Optimus are trademarks and/or registered trademarks of NVIDIA Corporation in the U.S. and other countries. SDHC, SDXC, and microSD are trademarks or registered trademarks of SD-3C LLC. Microsoft and Windows are either registered trademarks or trademarks of Microsoft Corporation in the United States and/or other countries. DisplayPort™ and the DisplayPort™ logo are trademarks owned by the Video Electronics Standards Association (VESA®) in the United States and other countries. Miracast is a registered trademark of Wi-Fi Alliance.

The information contained herein is subject to change without notice. The only warranties for HP products and services are set forth in the express warranty statements accompanying such products and services. Nothing herein should be construed as constituting an additional warranty. HP shall not be liable for technical or editorial errors or omissions contained herein.

First Edition: April 2020

Document Part Number: L98817-001

## Product notice

This guide describes features that are common to most models. Some features may not be available on your computer.

Not all features are available in all editions or versions of Windows. Systems may require upgraded and/or separately purchased hardware, drivers, software or BIOS update to take full advantage of Windows functionality. Windows 10 is automatically updated, which is always enabled. ISP fees may apply and additional requirements may apply over time for updates. Go to <http://www.microsoft.com> for details.

To access the latest user guides, go to <http://www.hp.com/support>, and follow the instructions to find your product. Then select **User Manuals**.

## Software terms

By installing, copying, downloading, or otherwise using any software product preinstalled on this computer, you agree to be bound by the terms of the HP End User License Agreement (EULA). If you do not accept these license terms, your sole remedy is to return the entire unused product (hardware and software) within 14 days for a full refund subject to the refund policy of your seller.

For any further information or to request a full refund of the price of the computer, please contact your seller.

## Safety warning notice

---

 **WARNING!** To reduce the possibility of heat-related injuries or of overheating the computer, do not place the computer directly on your lap or obstruct the computer air vents. Use the computer only on a hard, flat surface. Do not allow another hard surface, such as an adjoining optional printer, or a soft surface, such as pillows or rugs or clothing, to block airflow. Also, do not allow the AC adapter to contact the skin or a soft surface, such as pillows or rugs or clothing, during operation. The computer and the AC adapter comply with the user-accessible surface temperature limits defined by applicable safety standards.

---



---

# Table of contents

<b>1 Product description .....</b>	<b>1</b>
<b>2 Getting to know your computer .....</b>	<b>4</b>
Locating hardware .....	4
Locating software .....	4
Right side .....	5
Left side .....	6
Display .....	7
Low blue light mode (select products only) .....	7
Keyboard area .....	9
Touchpad .....	9
Touchpad settings .....	9
Lights .....	10
Button and fingerprint reader .....	11
Special keys .....	13
Bottom .....	14
Labels .....	15
<b>3 Illustrated parts catalog .....</b>	<b>17</b>
Computer major components .....	17
Display assembly subcomponents .....	27
Mass storage devices .....	28
Cables .....	29
Miscellaneous parts .....	30
<b>4 Removal and replacement procedures preliminary requirements .....</b>	<b>32</b>
Tools required .....	32
Service considerations .....	32
Plastic parts .....	32
Cables and connectors .....	32
Drive handling .....	33
Workstation guidelines .....	33
Electrostatic discharge information .....	33
Generating static electricity .....	34
Preventing electrostatic damage to equipment .....	34
Personal grounding methods and equipment .....	35

Grounding the work area .....	35
Recommended materials and equipment .....	35
Packaging and transporting guidelines .....	36
<b>5 Removal and replacement procedures for authorized service provider parts .....</b>	<b>37</b>
Component replacement procedures .....	37
Preparation for disassembly .....	37
Bottom cover and rubber feet .....	38
Battery .....	39
Touchpad .....	40
Speakers .....	42
Solid-state drive and Optane Memory Module .....	43
WLAN module .....	45
Fan .....	47
Heat sink .....	48
System board .....	50
IR sensor board .....	52
Display assembly .....	54
Power connector .....	62
Keyboard/top cover .....	63
<b>6 Backing up, restoring, and recovering .....</b>	<b>64</b>
Backing up information and creating recovery media .....	64
Using Windows tools .....	64
Using the HP Cloud Recovery Download Tool to create recovery media (select products only) .....	64
Restoring and recovery .....	65
Restoring, resetting, and refreshing using Windows tools .....	65
Recovering using HP Recovery media .....	65
Changing the computer boot order .....	65
Using HP Sure Recover (select products only) .....	66
<b>7 Using HP PC Hardware Diagnostics .....</b>	<b>67</b>
Using HP PC Hardware Diagnostics Windows (select products only) .....	67
Downloading HP PC Hardware Diagnostics Windows .....	67
Downloading the latest HP PC Hardware Diagnostics Windows version .....	68
Downloading HP Hardware Diagnostics Windows by product name or number (select products only) .....	68
Installing HP PC Hardware Diagnostics Windows .....	68
Using HP PC Hardware Diagnostics UEFI .....	68
Starting HP PC Hardware Diagnostics UEFI .....	69

Downloading HP PC Hardware Diagnostics UEFI to a USB flash drive .....	69
Downloading the latest HP PC Hardware Diagnostics UEFI version .....	69
Downloading HP PC Hardware Diagnostics UEFI by product name or number (select products only) .....	70
Using Remote HP PC Hardware Diagnostics UEFI settings (select products only) .....	70
Downloading Remote HP PC Hardware Diagnostics UEFI .....	70
Downloading the latest Remote HP PC Hardware Diagnostics UEFI version .....	70
Downloading Remote HP PC Hardware Diagnostics UEFI by product name or number .....	70
Customizing Remote HP PC Hardware Diagnostics UEFI settings .....	70
<b>8 Specifications .....</b>	<b>72</b>
Computer specifications .....	72
xx cm (xx-in) display specifications .....	73
Hard drive specifications .....	73
<b>9 Power cord set requirements .....</b>	<b>75</b>
Requirements for all countries .....	75
Requirements for specific countries and regions .....	76
<b>10 Recycling .....</b>	<b>78</b>
<b>Index .....</b>	<b>79</b>





# 1 Product description

**Table 1-1 Product components and their descriptions**

Category	Description
<b>Product Name</b>	HP ENVY 13 Laptop PC HP model numbers:13-ba0xxx, 13t-ba000
<b>Processors</b>	Intel® i5-1021 0U (1.6 GHz, turbo up to 4.2G GHz, BGA, 2666 MHz FSB, 6 MB L3 cache, quad core, UHD 620, 15W) Intel i5-1035 G1 (1.0 GHz, turbo up to 3.6G GHz, BGA, 3200 MHz FSB, 6 MB L3 cache, quad core, UHD 12W) Intel i5-1035 G4 (1.1 GHz, turbo up to 3.7G GHz, BGA, 3200 MHz FSB, 6 MB L3 cache, quad core, 12W) Intel i7-1051 0U (1.8 GHz, turbo up to 4.9 GHz, BGA, 2666 MHz FSB, 8 MB L3 cache, quad core, UHD 620, 15W) Intel i7-1065 G7 (1.3 GHz, turbo up to 3.9G GHz, BGA, 3200 MHz FSB, 8 MB L3 cache, quad core, 12W)
<b>Graphics</b>	<b>Hybrid graphics:</b> Nvidia GeForce™ MX350 with 2048 MB Graphic Controller of dedicated video memory
<b>Panel</b>	<b>33.8 cm (13.3 in) WLED (3.8 mm)</b> Full high-definition (FHD) (1920 × 1080) WLED UWVA 72 1000 eDP 1.4 + PSR2 with Privacy FHD (1920 × 1080) WLED UWVA 72 300 eDP 1.3 + PSR nontouch screen + FG, (DBCG) FHD (1920 × 1080) WLED UWVA 72 300 eDP 1.3 + PSR Touch screen (DBTS) VBM FHD (1920 × 1080) WLED UWVA sRGB 100 400 eDP 1.4 + PSR2 TS LP (DBTS) VBM FHD (1920 × 1080) WLED UWVA sRGB 100 400 eDP 1.4 + PSR2 nontouch + FG LP (DBTS) VBM UHD (3840 × 2160) WLED UWVA HDR-400 sRGB 95 550 eDP 1.4 + PSR 2
<b>Memory</b>	Two SODIMM slots, nonaccessible/nonupgradeable DDR4-3200 and DDR4-2666 dual-channel support Supports up to 16 GB maximum system memory in the following configurations: <ul style="list-style-type: none"> <li>• 16 GB 2666 DDR4 1.2v IC 16 GB × 16 × 8 pcs</li> <li>• 8 GB 2666 DDR4 1.2v IC 8 GB × 16 × 8 pcs</li> <li>• 8 GB 3200 DDR4 1.2v IC 8 GB × 16 × 8 pcs</li> </ul>
<b>Solid-state drives</b>	Support for solid-state drives Support for M.2 solid-state drive 1 TB, 2280 PCIe, NVMe, Value 1 TB, 2280 PCIe-3 × 4 NVMe, three layer cell 512 GB, 2280 PCIe, NVMe, Value 512 GB, 2280 PCIe, 3 × 2 × 2 NVMe + SSD, 32GB, 3D Xpoint 512 GB, M.2 2280 PCIe-3 × 4 NVMe, three layer cell

**Table 1-1 Product components and their descriptions (continued)**

<b>Category</b>	<b>Description</b>
	256 GB 2280 PCIe, NVMe, Value
	256 GB 2280 PCIe, 3 × 2 × 2 NVMe + SSD 16 GB 3D Xpoint
	256 GB M.2 2280 PCIe, 3 × 4 NVMe three layer cell
<b>Audio and video</b>	Audio Brand: BANG and OLUFSEN
	Supports HP Audio Boost 2.0 (with discrete amplifier)
	Dual speakers
<b>Video</b>	Fixed camera with dual array digital microphone, USB 2 Integrated HD
	720p with shutter
<b>Sensors</b>	IR Thermal Sensor
<b>Wireless</b>	<b>Integrated wireless option with dual antennas (M.2/PCIe)</b>
	Integrated wireless options with dual antennas (M.2/MIPI/BRI): Intel Wi-Fi 6 AX201 + BT5 (non-vPro) (802.11ax 2 × 2, MU-MIMO, supporting gigabit file transfer speeds)
	Integrated wireless options with dual antennas (LTE/MIPI/BRI): Intel Wi-Fi 6 AX201 + BT5 (non-vPro) (802.11ax 2 × 2, MU-MIMO, supporting gigabit file transfer speeds)
<b>Ports</b>	HP Smart Plug AC adapter
	Audio-out (headphone)/ Audio-in (microphone) combo jack
	Hot plug/unplug and autodetect for correct output to wide-aspect vs. standard aspect video (auto-adjust panel resolution to fit embedded panel and external monitor connected)
	USB 3.2 Gen1 Type A (2)
	USB 3.2 Gen 2 Type C port (1)
<b>Media card reader</b>	Supports HP MultiFormat microSD
<b>Internal card expansion</b>	One M.2 slot for WLAN
	One M.2 slot for solid-state drive
<b>Keyboard/pointing devices</b>	Backlit, full-sized, island-style, keyboard with numeric keypad
	Touchpad requirements
	ClickPad with image sensor
	Multitouch gestures enabled
	Support for Precision touchpad
<b>Power requirements</b>	<b>Battery</b>
	3-cell, 51 Whr, polymer/prismatic-mix battery
	Supports battery fast charge
	<b>AC adapter</b>
	65 W HP Smart AC adapter (non-PFC, slim black barrel, 4.5 mm, straight)
	AC Adapter 65 Watt Smart nPFC EM Barrel 4.5 mm
	<b>Power cord</b>

**Table 1-1 Product components and their descriptions (continued)**

<b>Category</b>	<b>Description</b>
	1 m, conventional power cord (C5) with plug adapter
<b>Security</b>	Trusted Platform Module (TPM) 2.0, firmware based
	Privacy camera cover
	Privacy screen
	Universal 2nd Factor Authentication
	Audio/mic mute
<b>Operating system</b>	<b>Preinstalled</b>
	Windows® Win 10 Home 64
	Win 10 Home 64 Advanced
	Win 10 Home 64 Advanced Single Language
	Win 10 Home 64 High-End Chinese Market CPPP
	Win 10 Home 64 Plus
	Win 10 Home 64 Plus Single Language
	Win 10 Home 64 Plus Single Language Africa Market PPP
	Win 10 Home 64 Plus Single Language APAC EM PPP
	Win 10 Home 64 Plus Single Language India Market PPP
	Win 10 Home 64 Plus Single Language Indonesia Market PPP
	Win 10 Pro 64
<b>Serviceability</b>	<b>End user replaceable parts:</b>
	AC adapter

---

## 2 Getting to know your computer

Your computer features top-rated components. This chapter provides details about your components, where they are located, and how they work.

---

 **NOTE:** Actual computer color, features, feature locations, icon labels, and accessories might vary from the images depicted.

---

### Locating hardware

To find out what hardware is installed on your computer:

- ▲ Type `device manager` in the taskbar search box, and then select the **Device Manager** app.

A list displays all the devices installed on your computer.

For information about system hardware components and the system BIOS version number, press `fn+esc` (select products only).

### Locating software



Software can vary by product. To find out what software is installed on your computer:

- ▲ Right-click the **Start** button, and then select **Apps and Features**.

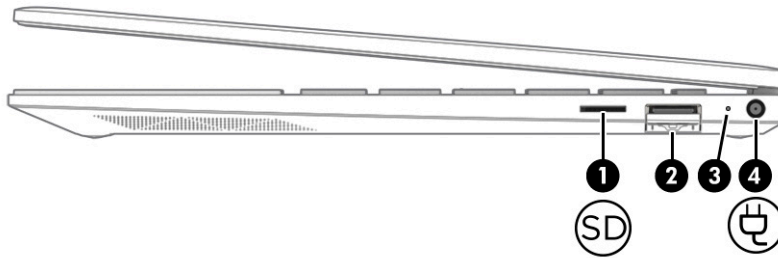
## Right side

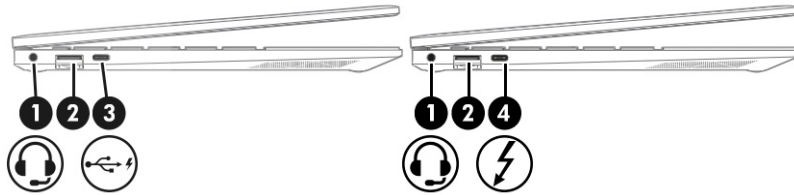

**Table 2-1 Right-side components and their descriptions**



Component	Description
(1)  microSD™ memory card reader	<p>Reads optional memory cards that enable you to store, manage, share, or access information.</p> <p>To insert a card:</p> <ol style="list-style-type: none"> <li>1. Hold the card label-side up, with connectors facing the computer.</li> <li>2. Insert the card into the memory card reader, and then press in on the card until it is firmly seated.</li> </ol> <p>To remove a card:</p> <ul style="list-style-type: none"> <li>▲ Press in on the card, and then remove it from the memory card reader.</li> </ul>
(2) USB port with HP Sleep and Charge	Connects a USB device, provides high-speed data transfer, and charges small devices, even when the computer is off.
(3) AC adapter and battery light	<ul style="list-style-type: none"> <li>• White: The AC adapter is connected and the battery is fully charged.</li> <li>• Blinking white (select products only): The AC adapter is disconnected and the battery has reached a low battery level.</li> <li>• Amber: The AC adapter is connected and the battery is charging.</li> <li>• Off: The battery is not charging.</li> </ul>
(4)  Power connector	Connects an AC adapter.

# Left side

 **NOTE:** Refer to the illustration that most closely matches your computer.



**Table 2-2** Left-side components and their descriptions

Component	Description
<p>(1)  Audio-out (headphone)/Audio-in (microphone) combo jack</p>	<p>Connects optional powered stereo speakers, headphones, earbuds, a headset, or a television audio cable. Also connects an optional headset microphone. This jack does not support optional standalone microphones.</p> <p><b>WARNING!</b> To reduce the risk of personal injury, adjust the volume before putting on headphones, earbuds, or a headset. For additional safety information, see the <i>Regulatory, Safety, and Environmental Notices</i>.</p> <p>To access this guide:</p> <ul style="list-style-type: none"> <li>▲ Type <b>HP Documentation</b> in the taskbar search box, and then select <b>HP Documentation</b>.</li> </ul> <p><b>NOTE:</b> When a device is connected to the jack, the computer speakers are disabled.</p>
<p>(2) USB port</p>	<p>Connects a USB device, provides data transfer, and (for select products) charges small devices, even when the computer is on or in Sleep mode.</p>
<p>(3)  USB Type-C port with HP Sleep and Charge (select products only)</p>	<p>Connects a USB device, provides data transfer, and charges small devices, even when the computer is off.</p> <p>– and –</p> <p>Connects a display device that has a USB Type-C connector, providing DisplayPort™ output.</p> <p><b>NOTE:</b> Cables, adapters, or both (purchased separately) might be required.</p>
<p>(4)  USB Type-C Thunderbolt™ port with HP Sleep and Charge (select products only)</p>	<p>Connects a USB device, provides high-speed data transfer, and charges small devices, even when the computer is off.</p> <p>– and –</p> <p>Connects a display device that has a USB Type-C connector, providing DisplayPort output.</p> <p><b>NOTE:</b> Your computer might also support a Thunderbolt docking station.</p> <p><b>NOTE:</b> Cables, adapters, or both (purchased separately) might be required.</p>

# Display

## Low blue light mode (select products only)

Your computer display is shipped from the factory in low blue light mode for improved eye comfort and safety. Also, blue light mode automatically adjusts blue light emissions when you are using the computer at night or for reading.

**⚠ WARNING!** To reduce the risk of serious injury, read the *Safety & Comfort Guide*. It describes proper workstation setup and proper posture, health, and work habits for computer users. The *Safety & Comfort Guide* also provides important electrical and mechanical safety information. The *Safety & Comfort Guide* is available on the web at <http://www.hp.com/ergo>.

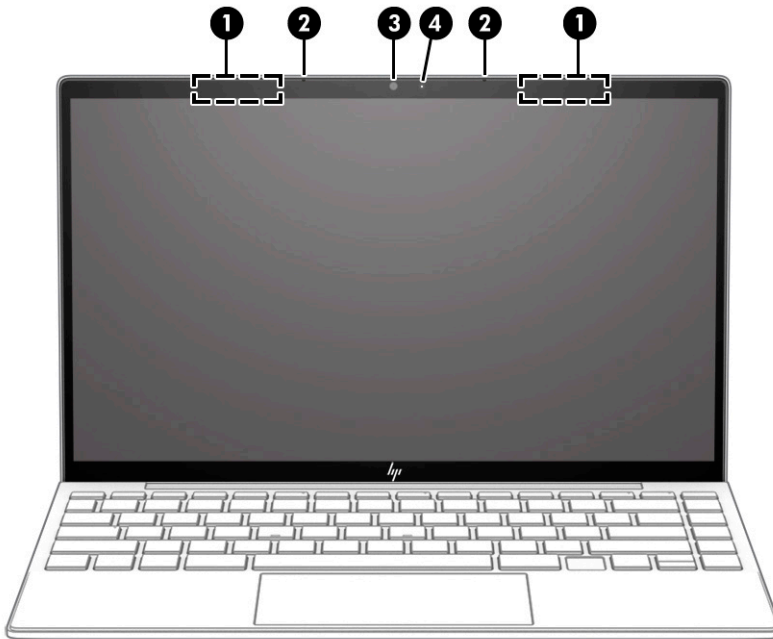

**Table 2-3 Display components and their descriptions**

Component	Description
(1) WLAN antennas*	Send and receive wireless signals to communicate with wireless local area networks (WLANs).
(2) Internal microphones	Record sound.
(3) Camera	Allows you to video chat, record video, and record still images. Some cameras also allow a facial recognition logon to Windows, instead of a password logon. <b>NOTE:</b> To turn the camera on or off, press the camera privacy key. When the camera is turned on, the camera light is on, and the camera privacy key light is turned off. When the camera is turned off, the camera light is off, and the camera privacy light is turned on. <b>NOTE:</b> Camera functions vary depending on the camera hardware and software installed on your product.
(4) Camera light	On: The camera is in use.

\*The antennas are not visible from the outside of the computer. For optimal transmission, keep the areas immediately around the antennas free from obstructions.

**Table 2-3 Display components and their descriptions (continued)**

Component	Description
For wireless regulatory notices, see the section of the <i>Regulatory, Safety, and Environmental Notices</i> that applies to your country or region.	To access this guide:
▲	Type <code>HP Documentation</code> in the taskbar search box, and then select <b>HP Documentation</b> .



# Keyboard area

 **NOTE:** Keyboards can vary by language.

## Touchpad

### Touchpad settings

To adjust touchpad settings and gestures, or to turn off the touchpad:

1. Type `touchpad settings` in the taskbar search box, and then press [enter](#).
2. Choose a setting.

To turn on the touchpad:

1. Type `touchpad settings` in the taskbar search box, and then press [enter](#).
2. Using an external mouse, click the **touchpad** button.

– or –

- ▲ Press the [Tab](#) key repeatedly until the pointer rests on the **touchpad** button. Then press the [spacebar](#) to select the button.

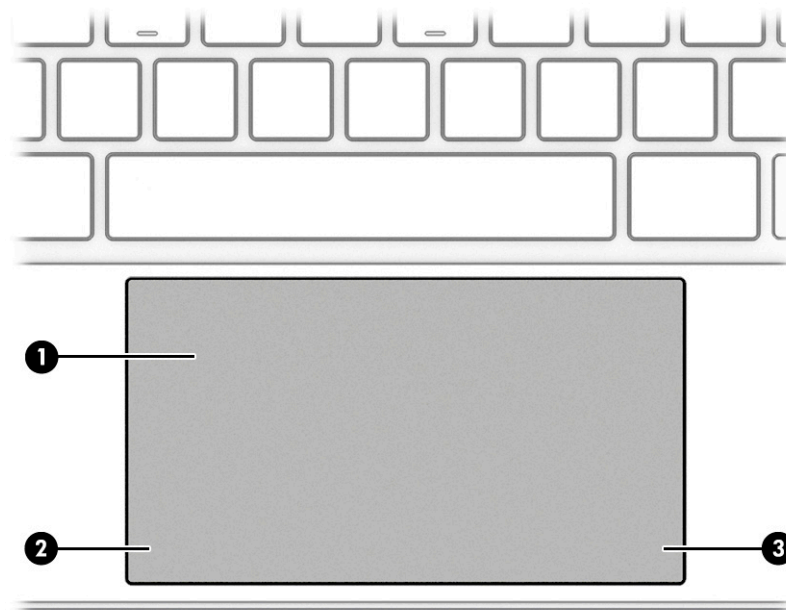



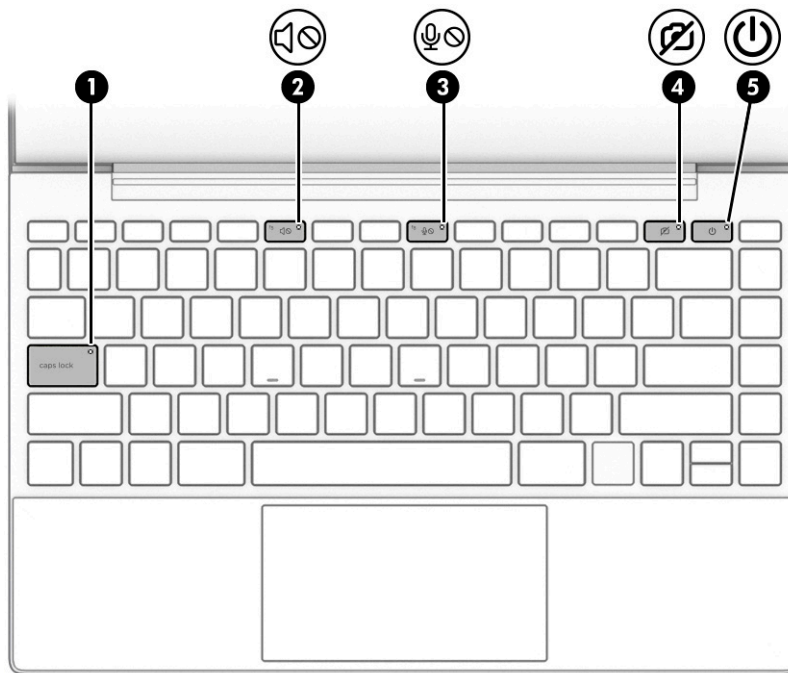

**Table 2-4 Touchpad components and their descriptions**

Component	Description
(1) Touchpad zone	Reads your finger gestures to move the pointer or activate items on the screen.
(2) Left touchpad button	Functions like the left button on an external mouse.
(3) Right touchpad button	Functions like the right button on an external mouse.

## Lights





**Table 2-5** Lights and their descriptions

Component	Description
(1) Caps lock light	On: Caps lock is on, which switches the key input to all capital letters.
(2)  Mute light	<ul style="list-style-type: none"><li>On: Computer sound is off.</li><li>Off: Computer sound is on.</li></ul>
(3)  Microphone mute light	<ul style="list-style-type: none"><li>On: Microphone is off.</li><li>Off: Microphone is on.</li></ul>
(4)  Camera privacy light	<ul style="list-style-type: none"><li>On: The camera is off.</li><li>Off: The camera is on.</li></ul>
(5)  Power light	<ul style="list-style-type: none"><li>On: The computer is on.</li><li>Blinking (select products only): The computer is in the Sleep state, a power-saving state. The computer shuts off power to the display and other unnecessary components.</li><li>Off: Depending on your computer model, the computer is off, in Hibernation, or in Sleep. Hibernation is the power-saving state that uses the least amount of power.</li></ul>

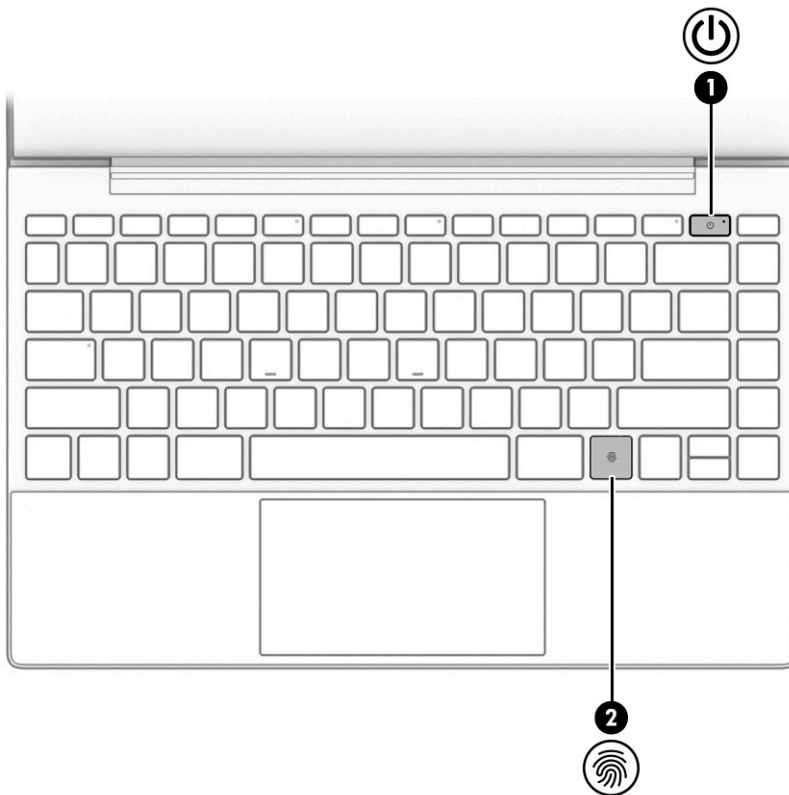
## Button and fingerprint reader



**Table 2-6** Button and fingerprint reader and their descriptions

Component	Description
(1)  Power button	<ul style="list-style-type: none"> <li>• When the computer is off, press the button to turn on the computer.</li> <li>• When the computer is on, press the button briefly to initiate Sleep.</li> <li>• When the computer is in the Sleep state, press the button briefly to exit Sleep (select products only).</li> <li>• When the computer is in Hibernation, press the button briefly to exit Hibernation.</li> </ul> <p><b>IMPORTANT:</b> Pressing and holding down the power button results in the loss of unsaved information.</p> <p>If the computer has stopped responding and shutdown procedures are ineffective, press and hold the power button down for at least 10 seconds to turn off the computer.</p> <p>To learn more about your power settings, see your power options:</p> <ul style="list-style-type: none"> <li>▲ Right-click the <b>Power</b> icon and then select <b>Power Options</b>.</li> </ul>
(2)  Fingerprint reader	<p>Allows a fingerprint logon to Windows, instead of a password logon.</p> <ul style="list-style-type: none"> <li>▲ Touch your finger to the fingerprint reader.</li> </ul>



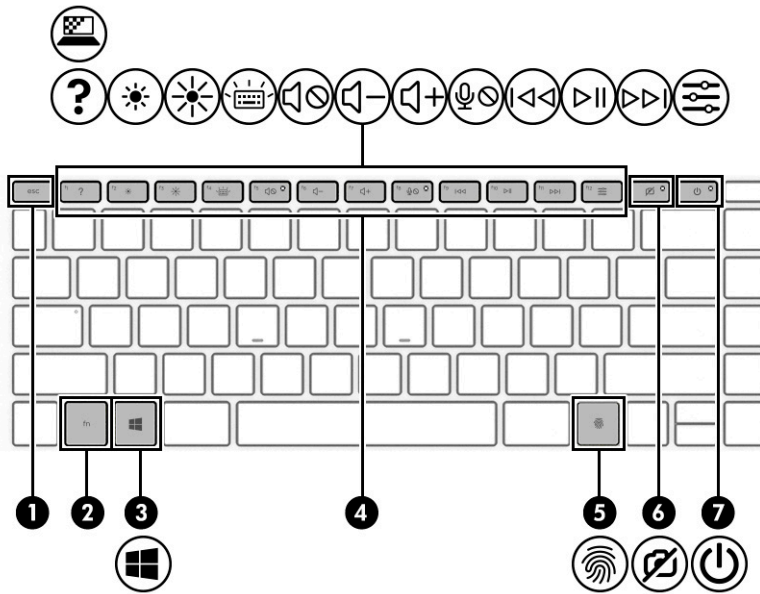

**Table 2-6** Button and fingerprint reader and their descriptions (continued)

Component	Description
	<b>IMPORTANT:</b> To prevent fingerprint login issues, be sure when you register your fingerprint that all sides of your finger are registered by the fingerprint reader.

## Special keys



**Table 2-7** Special keys and their descriptions

Component	Description
(1) <code>esc</code> key	Displays system information when pressed in combination with the <code>fn</code> key.
(2) <code>fn</code> key	Executes specific functions when pressed in combination with another key.
(3)  Windows key	Opens the Start menu. <b>NOTE:</b> Pressing the Windows key again will close the Start menu.
(4) Action keys	Execute frequently used system functions as defined by the icon symbols on the <code>f1</code> through <code>f12</code> keys. The action keys vary by computer. .
(5)  Fingerprint reader	Allows a fingerprint logon to Windows, instead of a password logon.  ▲ Touch your finger to the fingerprint reader.  <b>IMPORTANT:</b> To prevent fingerprint logon issues, be sure when you register your fingerprint that all sides of your finger are registered by the fingerprint reader.
(6)  Camera privacy key	Turns the camera off and on.
(7)  Power button	<ul style="list-style-type: none"> <li>When the computer is off, press the button to turn on the computer.</li> <li>When the computer is on, press the button briefly to initiate Sleep.</li> <li>When the computer is in the Sleep state, press the button briefly to exit Sleep (select products only).</li> </ul>

**Table 2-7 Special keys and their descriptions (continued)**

Component	Description
	<ul style="list-style-type: none"><li>When the computer is in Hibernation, press the button briefly to exit Hibernation.</li></ul> <p><b>IMPORTANT:</b> Pressing and holding down the power button results in the loss of unsaved information.</p> <p>If the computer has stopped responding and shutdown procedures are ineffective, press and hold the power button down for at least 10 seconds to turn off the computer.</p> <p>To learn more about your power settings, see your power options:</p> <ul style="list-style-type: none"><li>Right-click the <b>Power</b> icon , and then select <b>Power Options</b>.</li></ul>

## Bottom

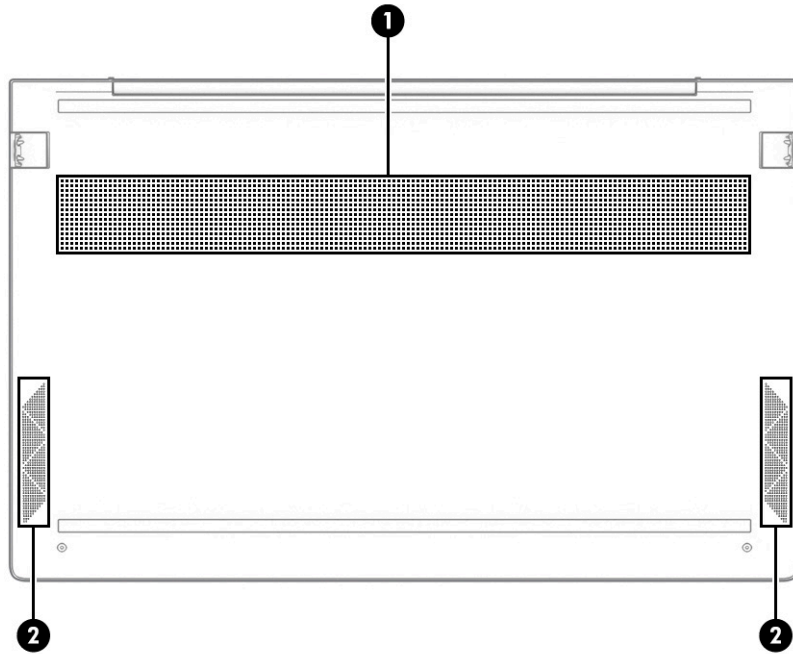

**Table 2-8 Bottom components and their descriptions**

Component	Description
(1) Vent	Enables airflow to cool internal components. <b>NOTE:</b> The computer fan starts up automatically to cool internal components and prevent overheating. It is normal for the internal fan to cycle on and off during routine operation.
(2) Speakers (2)	Produce sound.

# Labels

The labels affixed to the computer provide information that you might need when you troubleshoot system problems or travel internationally with the computer. Labels can be in paper form or imprinted on the product.

**IMPORTANT:** Check the following locations for the labels described in this section: the bottom of the computer, inside the battery bay, under the service door, on the back of the display, or on the bottom of a tablet kickstand.

- Service label—Provides important information to identify your computer. When contacting support, you might be asked for the serial number, the product number, or the model number. Locate this information before you contact support.

Your service label will resemble one of the following examples. Refer to the illustration that most closely matches the service label on your computer.

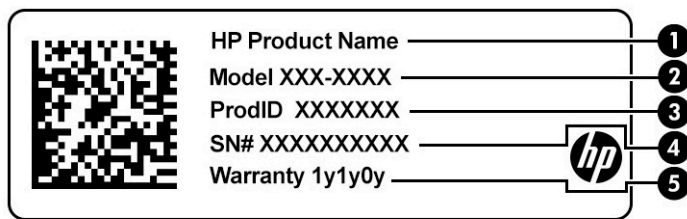

**Table 2-9 Service label components**

Component
(1) HP product name
(2) Model number
(3) Product ID
(4) Serial number
(5) Warranty period

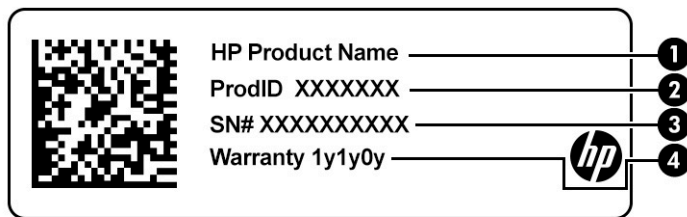

**Table 2-10 Service label components**

Component
(1) HP product name
(2) Product ID

**Table 2-10 Service label components (continued)**

<b>Component</b>	
<b>(3)</b>	Serial number
<b>(4)</b>	Warranty period

- Regulatory label(s)—Provide(s) regulatory information about the computer.
- Wireless certification label(s)—Provide(s) information about optional wireless devices and the approval markings for the countries or regions in which the devices have been approved for use.



---

## 3 Illustrated parts catalog

### Computer major components

---

 **NOTE:** HP continually improves and changes product parts. For complete and current information about supported parts for your computer, go to <http://partsurfer.hp.com>, select your country or region, and then follow the on-screen instructions.

 **NOTE:** Details about your computer, including model, serial number, product key, and length of warranty, are on the service tag at the bottom of your computer.

---

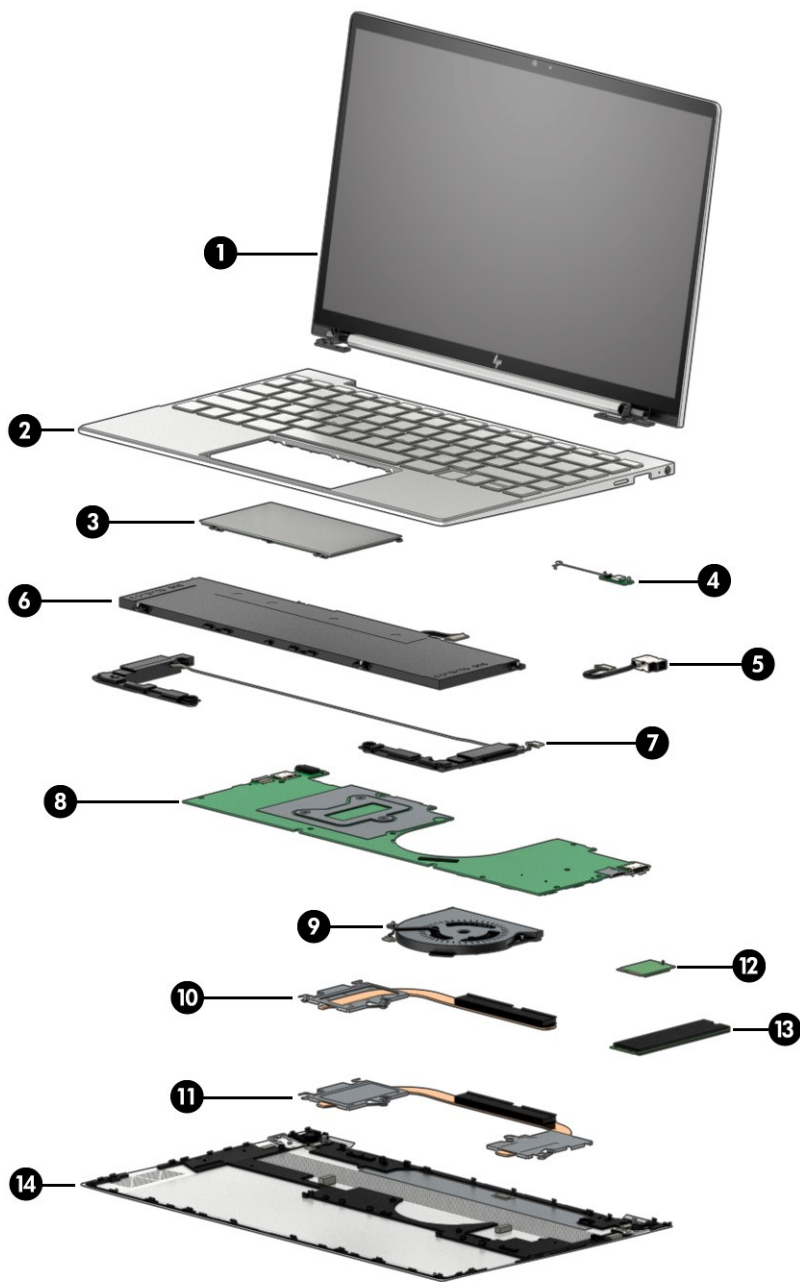

**Table 3-1 Computer major components and their descriptions**

Item	Component	Spare part number
(1)	<b>Display assembly</b>	
	FHD natural silver finish nontouch screen	L96778-001
	FHD pale gold finish nontouch screen	L96779-001
	FHD nightfall black finish nontouch screen	L96780-001
	FHD natural silver finish touch screen	L96781-001
	FHD pale gold finish touch screen	L96782-001
	FHD nightfall black finish touch screen	L96783-001

**Table 3-1 Computer major components and their descriptions (continued)**

<b>Item</b>	<b>Component</b>	<b>Spare part number</b>
	FHD natural silver finish nontouch screen	L96784-001
	FHD pale gold finish nontouch screen	L96785-001
	FHD nightfall black finish nontouch screen	L96786-001
	FHD natural silver finish touch screen	L96787-001
	FHD pale gold finish touch screen	L96788-001
	FHD nightfall black finish touch screen	L96789-001
	FHD natural silver finish nontouch screen with privacy	L96790-001
	FHD pale gold finish nontouch screen with privacy	L96791-001
	FHD nightfall black finish nontouch screen with privacy	L96792-001
	FHD natural silver finish touch screen with privacy	L96793-001
	FHD pale gold finish touch screen with privacy	L96794-001
	FHD nightfall black finish touch screen with privacy	L96795-001
	UHD natural silver finish touch screen	L96796-001
	UHD pale gold finish touch screen	L96797-001
	UHD nightfall black finish touch screen	L96798-001
<b>(2)</b>	<b>Top cover</b> with keyboard	
	For use in the United States in natural silver finish with backlight	L96799-001
	For use in the United Kingdom in natural silver finish with backlight	L96799-031
	For use in Germany in natural silver finish with backlight	L96799-041
	For use in France in natural silver finish with backlight	L96799-051
	For use in Italy in natural silver finish with backlight	L96799-061
	For use in Portugal in natural silver finish with backlight	L96799-131
	For use in Turkey in natural silver finish with backlight	L96799-141
	For use in Greece in natural silver finish with backlight	L96799-151
	For use in Latin America in natural silver finish with backlight	L96799-161
	For use in Saudi Arabia in natural silver finish with backlight	L96799-171
	For use in Hungary in natural silver finish with backlight	L96799-211
	For use in Russia in natural silver finish with backlight	L96799-251
	For use in Bulgaria in natural silver finish with backlight	L96799-261
	For use in Romania in natural silver finish with backlight	L96799-271
	For use in Thailand in natural silver finish with backlight	L96799-281
	For use in Belgium in natural silver finish with backlight	L96799-A41
	For use in Taiwan in natural silver finish with backlight	L96799-AB1

**Table 3-1 Computer major components and their descriptions (continued)**

<b>Item</b>	<b>Component</b>	<b>Spare part number</b>
	For use in Korea in natural silver finish with backlight	L96799-AD1
	For International use in natural silver finish with backlight	L96799-B31
	For use in Slovenia in natural silver finish with backlight	L96799-BA1
	For use in Israel in natural silver finish with backlight	L96799-BB1
	For use in Switzerland in natural silver finish with backlight	L96799-BG1
	For use in Ukraine in natural silver finish with backlight	L96799-BD1
	For use in French Canada in natural silver finish with backlight	L96799-DB1
	For use in Denmark, Sweden, Finland, and Norway in natural silver finish with backlight	L96799-DH1
	For use in the Czech Republic and Slovakia in natural silver finish with backlight	L96799-FL1
	For use in the United States in natural silver finish with backlight and privacy	L96800-001
	For use in the United Kingdom in natural silver finish with backlight and privacy	L96800-031
	For use in Germany in natural silver finish with backlight and privacy	L96800-041
	For use in France in natural silver finish with backlight and privacy	L96800-051
	For use in Italy in natural silver finish with backlight and privacy	L96800-061
	For use in Spain in natural silver finish with backlight and privacy	L96800-071
	For use in Portugal in natural silver finish with backlight and privacy	L96800-131
	For use in Turkey in natural silver finish with backlight and privacy	L96800-141
	For use in Greece in natural silver finish with backlight and privacy	L96800-151
	For use in Saudi Arabia in natural silver finish with backlight and privacy	L96800-171
	For use in Hungary in natural silver finish with backlight and privacy	L96800-211
	For use in Russia in natural silver finish with backlight and privacy	L96800-251
	For use in Bulgaria in natural silver finish with backlight and privacy	L96800-261
	For use in Romania in natural silver finish with backlight and privacy	L96800-271
	For use in Thailand in natural silver finish with backlight and privacy	L96800-281
	For use in Belgium in natural silver finish with backlight and privacy	L96800-A41
	For use in Taiwan in natural silver finish with backlight and privacy	L96800-AB1
	For use in Korea in natural silver finish with backlight and privacy	L96800-AD1
	For International use in natural silver finish with backlight and privacy	L96800-B31
	For use in Slovenia in natural silver finish with backlight and privacy	L96800-BA1
	For use in Israel in natural silver finish with backlight and privacy	L96800-BB1
	For use in the Ukraine in natural silver finish with backlight and privacy	L96800-BD1
	For use in Switzerland in natural silver finish with backlight and privacy	L96800-BG1
	For use in French Canada in natural silver finish with backlight and privacy	L96800-DB1

**Table 3-1 Computer major components and their descriptions (continued)**

<b>Item</b>	<b>Component</b>	<b>Spare part number</b>
	For use in Denmark, Sweden, Finland, and Norway in natural silver finish with backlight and privacy	L96800-DH1
	For use in Czechoslovakia and Slovenia in natural silver finish with backlight and privacy	L96800-FL1
	For use in the United States in natural silver finish with backlight	L96801-001
	For use in the United Kingdom in natural silver finish with backlight	L96801-031
	For use in Germany in natural silver finish with backlight	L96801-041
	For use in France in natural silver finish with backlight	L96801-051
	For use in Italy in natural silver finish with backlight	L96801-061
	For use in Portugal in natural silver finish with backlight	L96801-131
	For use in Turkey in natural silver finish with backlight	L96801-141
	For use in Greece in natural silver finish with backlight	L96801-151
	For use in Latin America in natural silver finish with backlight	L96801-161
	For use in Saudi Arabia in natural silver finish with backlight	L96801-171
	For use in Hungary in natural silver finish with backlight	L96801-211
	For use in Russia in natural silver finish with backlight	L96801-251
	For use in Bulgaria in natural silver finish with backlight	L96801-261
	For use in Romania in natural silver finish with backlight	L96801-271
	For use in Thailand in natural silver finish with backlight	L96801-281
	For use in Belgium in natural silver finish with backlight	L96801-A41
	For use in Taiwan in natural silver finish with backlight	L96801-AB1
	For use in Korea in natural silver finish with backlight	L96801-AD1
	For International use in natural silver finish with backlight	L96801-B31
	For use in Slovenia in natural silver finish with backlight	L96801-BA1
	For use in Israel in natural silver finish with backlight	L96801-BB1
	For use in the Ukraine in natural silver finish with backlight	L96801-BD1
	For use in Switzerland in natural silver finish with backlight	L96801-BG1
	For use in French Canada in natural silver finish with backlight	L96801-DB1
	For use in Denmark, Finland, Sweden, and Norway in natural silver finish with backlight	L96801-DH1
	For use in the Czech Republic and Slovakia in natural silver finish with backlight	L96801-FL1
	For use in the United States in natural silver finish with backlight and privacy	L96802-001
	For use in the United Kingdom in natural silver finish with backlight and privacy	L96802-031
	For use in Germany in natural silver finish with backlight and privacy	L96802-041
	For use in France in natural silver finish with backlight and privacy	L96802-051
	For use in Italy in natural silver finish with backlight and privacy	L96802-061

**Table 3-1 Computer major components and their descriptions (continued)**

<b>Item</b>	<b>Component</b>	<b>Spare part number</b>
	For use in Spain in natural silver finish with backlight and privacy	L96802-071
	For use in Portugal in natural silver finish with backlight and privacy	L96802-131
	For use in Turkey in natural silver finish with backlight and privacy	L96802-141
	For use in Greece in natural silver finish with backlight and privacy	L96802-151
	For use in Saudi Arabia in natural silver finish with backlight and privacy	L96802-171
	For use in Hungary in natural silver finish with backlight and privacy	L96802-211
	For use in Russia in natural silver finish with backlight and privacy	L96802-251
	For use in Bulgaria in natural silver finish with backlight and privacy	L96802-261
	For use in Romania in natural silver finish with backlight and privacy	L96802-271
	For use in Thailand in natural silver finish with backlight and privacy	L96802-281
	For use in Belgium in natural silver finish with backlight and privacy	L96802-A41
	For use in Taiwan in natural silver finish with backlight and privacy	L96802-AB1
	For use in Korea in natural silver finish with backlight and privacy	L96802-AD1
	For International use in natural silver finish with backlight and privacy	L96802-B31
	For use in Slovenia in natural silver finish with backlight and privacy	L96802-BA1
	For use in Israel in natural silver finish with backlight and privacy	L96802-BB1
	For use in Ukraine in natural silver finish with backlight and privacy	L96802-BD1
	For use in Switzerland in natural silver finish with backlight and privacy	L96802-BG1
	For use in French Canada in natural silver finish with backlight and privacy	L96802-DB1
	For use in Denmark, Finland, Sweden, and Norway in natural silver finish with backlight and privacy	L96802-DH1
	For use in the Czech Republic and Slovakia in natural silver finish with backlight and privacy	L96802-FL1
	For use in the United States in pale gold finish with backlight	L96803-001
	For use in the United Kingdom in pale gold finish with backlight	L96803-031
	For use in Germany in pale gold finish with backlight	L96803-041
	For use in France in pale gold finish with backlight	L96803-051
	For use in Italy in pale gold finish with backlight	L96803-061
	For use in Portland in pale gold finish with backlight	L96803-131
	For use in Turkey in pale gold finish with backlight	L96803-141
	For use in Greece in pale gold finish with backlight	L96803-151
	For International use in pale gold finish with backlight	L96803-161
	For use in Saudi Arabia in pale gold finish with backlight	L96803-171
	For use in Hungary in pale gold finish with backlight	L96803-211

**Table 3-1 Computer major components and their descriptions (continued)**

<b>Item</b>	<b>Component</b>	<b>Spare part number</b>
	For use in Russia in pale gold finish with backlight	L96803-251
	For use in Bulgaria in pale gold finish with backlight	L96803-261
	For use in Romania in pale gold finish with backlight	L96803-271
	For use in Thailand in pale gold finish with backlight	L96803-281
	For use in Japan in pale gold finish with backlight	L96803-291
	For use in Belgium in pale gold finish with backlight	L96803-A41
	For use in Taiwan in pale gold finish with backlight	L96803-AB1
	For use in Korea in pale gold finish with backlight	L96803-AD1
	For International use in pale gold finish with backlight	L96803-B31
	For use in Slovenia in pale gold finish with backlight	L96803-BA1
	For use in Israel in pale gold finish with backlight	L96803-BB1
	For use in Ukraine in pale gold finish with backlight	L96803-BD1
	For use in Switzerland in pale gold finish with backlight	L96803-BG1
	For use in French Canada in pale gold finish with backlight	L96803-DB1
	For use in Denmark, Finland, Sweden, and Norway in pale gold finish with backlight	L96803-DH1
	For use in the Czech Republic and Slovakia in pale gold finish with backlight	L96803-FL1
	For use in the United States in pale gold finish with backlight	L96804-001
	For use in the United Kingdom in pale gold finish with backlight	L96804-031
	For use in Germany in pale gold finish with backlight	L96804-041
	For use in France in pale gold finish with backlight	L96804-051
	For use in Italy in pale gold finish with backlight	L96804-061
	For use in Portugal in pale gold finish with backlight	L96804-131
	For use in Turkey in pale gold finish with backlight	L96804-141
	For use in Greece in pale gold finish with backlight	L96804-151
	For use in Latin America in pale gold finish with backlight	L96804-161
	For use in Saudi Arabia in pale gold finish with backlight	L96804-171
	For use in Hungary in pale gold finish with backlight	L96804-211
	For use in Russia in pale gold finish with backlight	L96804-251
	For use in Bulgaria in pale gold finish with backlight	L96804-261
	For use in Romania in pale gold finish with backlight	L96804-271
	For use in Thailand in pale gold finish with backlight	L96804-281
	For use in Japan in pale gold finish with backlight	L96804-291
	For use in Belgium in pale gold finish with backlight	L96804-A41

**Table 3-1 Computer major components and their descriptions (continued)**

<b>Item</b>	<b>Component</b>	<b>Spare part number</b>
	For use in Taiwan in pale gold finish with backlight	L96804-AB1
	For use in Korea in pale gold finish with backlight	L96804-AD1
	For International use in pale gold finish with backlight	L96804-B31
	For use in Slovenia in pale gold finish with backlight	L96804-BA1
	For use in Israel in pale gold finish with backlight	L96804-BB1
	For use in the Ukraine in pale gold finish with backlight	L96804-BD1
	For use in Switzerland in pale gold finish with backlight	L96804-BG1
	For use in French Canada in pale gold finish with backlight	L96804-DB1
	For use in Denmark, Finland, Norway, and Sweden in pale gold finish with backlight	L96804-DH1
	For use in the Czech Republic and Slovakia in pale gold finish with backlight	L96804-FL1
	<b>Top cover</b> with keyboard and touchpad (touchpad cannot be replaced)	
	For use in United States with wood veneer and backlight	L96805-001
	For use in Latin American with wood veneer and backlight	L96805-161
	For use in Thailand with wood veneer and backlight	L96805-281
	For use in Taiwan with wood veneer and backlight	L96805-AB1
	For use in Korea with wood veneer and backlight	L96805-AD1
	For use in French Canada with wood veneer and backlight	L96805-DB1
	For use in the United States with wood veneer, backlight, and privacy	L96806-001
	For use in the United Kingdom with wood veneer, backlight, with privacy	L96806-031
	For use in Germany with wood veneer, backlight with privacy	L96806-041
	For use in France with wood veneer, backlight and privacy	L96806-051
	For use in Italy with wood veneer, backlight, and privacy	L96806-061
	For use in Spain with wood veneer and backlight	L96806-071
	For use in Portugal with wood veneer, backlight, and privacy	L96806-131
	For use in Turkey with wood veneer, backlight, and privacy	L96806-141
	For use in Saudi Arabia with wood veneer, backlight, and privacy	L96806-171
	For use in Hungary in nightfall black finish with wood veneer and backlight	L96806-211
	For use in Russia with wood veneer, backlight, and privacy	L96806-251
	For use in Bulgaria with wood veneer, backlight, and privacy	L96806-261
	For use in Romania with wood veneer, backlight, and privacy	L96806-271
	For use in Belgium with wood veneer, backlight, and privacy	L96806-A41
	For International use with wood veneer, backlight and privacy	L96806-B31
	For use in Slovenia with wood veneer, backlight and privacy	L96806-BA1



**Table 3-1 Computer major components and their descriptions (continued)**

<b>Item</b>	<b>Component</b>	<b>Spare part number</b>
	For use in Israel with wood veneer, backlight and privacy	L96806-BB1
	For use in the Ukraine with wood veneer, backlight and privacy	L96806-BD1
	For use in Switzerland with wood veneer, backlight and privacy	L96806-BG1
	For use in French Canada with wood veneer, backlight and privacy	L96806-DB1
	For use in Denmark, Finland, Norway, and Sweden with wood veneer, backlight and privacy	L96806-DH1
	For use in the Czech Republic and Slovakia with wood veneer, backlight and privacy	L96806-FL1
	For use in the United States with wood veneer and backlight	L96807-001
	For use in Latin America with wood veneer and backlight	L96807-161
	For use in Thailand with wood veneer and backlight	L96807-281
	For use in Taiwan with wood veneer and backlight	L96807-AB1
	For use in Korea with wood veneer and backlight	L96807-AD1
	For use in French Canada with wood veneer and backlight	L96807-DB1
	For use in the United States with wood veneer, backlight, and privacy	L96808-001
	For use in the United Kingdom with wood veneer, backlight, and privacy	L96808-031
	For use in Germany with wood veneer, backlight, and privacy	L96808-041
	For use in France with wood veneer, backlight, and privacy	L96808-051
	For use in Italy with wood veneer, backlight, and privacy	L96808-061
	For use in Spain with wood veneer, backlight, and privacy	L96808-071
	For use in Portugal with wood veneer, backlight, and privacy	L96808-131
	For use in Turkey with wood veneer, backlight, and privacy	L96808-141
	For use in Saudi Arabia with wood veneer, backlight, and privacy	L96808-171
	For use in Hungary with wood veneer, backlight, and privacy	L96808-211
	For use in Russia with wood veneer, backlight, and privacy	L96808-251
	For use in Bulgaria with wood veneer, backlight, and privacy	L96808-261
	For use in Romania with wood veneer, backlight, and privacy	L96808-271
	For use in Belgium with wood veneer, backlight, and privacy	L96808-A41
	For international use with wood veneer, backlight, and privacy	L96808-B31
	For use in Slovenia with wood veneer, backlight, and privacy	L96808-BA1
	For use in Israel with wood veneer, backlight, and privacy	L96808-BB1
	For use in the Ukraine with wood veneer, backlight, and privacy	L96808-BD1
	For use in the Switzerland with wood veneer, backlight, and privacy	L96808-BG1
	For use in French Canada with wood veneer, backlight, and privacy	L96808-DB1

**Table 3-1 Computer major components and their descriptions (continued)**

Item	Component	Spare part number
	For use in Denmark, Finland, Norway and Sweden with wood veneer, backlight, and privacy	L96808-DH1
	For use in the Czech Republic and Slovakia with wood veneer, backlight, and privacy	L96808-FL1
<b>(3)</b>	<b>Touchpad</b>	
	<b>NOTE:</b> The touchpad spare part kit does not include the touchpad cable. The touchpad cable is available using spare part number L94032-001.	
	In natural silver finish	L94034-001
	In pale gold finish	L94033-001.
<b>(4)</b>	<b>IR sensor board</b>	L94039-001
<b>(5)</b>	<b>Power connector/cable</b>	L94044-001
<b>(6)</b>	<b>Battery</b>	L77034-005
<b>(7)</b>	<b>Speaker kit</b>	L94045-001
<b>(8)</b>	<b>System board</b>	
	Intel Core i5-1035 G1 processor and 8 GB of UMA graphics memory	L94589-601
	Intel Core i5-1035 G4 processor and 8 GB of UMA graphics memory	L94590-601
	Intel Core i7-1065 G7 processor and 8 GB of UMA graphics memory	L94591-601
	Intel Core i5-1021 U8 processor and 2 GB of discrete graphics memory	L94592-601
	Intel Core i7-1051 U8 processor and 2 GB of discrete graphics memory	L94593-601
	Intel Core i7-1051 U16 processor and 2 GB of discrete graphics memory	L94594-601
<b>(9)</b>	<b>Fan</b>	L94043-001
<b>(10)</b>	<b>Heat sink</b>	L94041-001
	Thermal module, for models with discrete memory	
<b>(11)</b>	Thermal module for models with UMA memory	L94042-001
<b>(12)</b>	<b>WLAN module</b>	
	Intel Wireless-AC 9560 802.11ac 2 × 2 Wi-Fi + Bluetooth® 5 (non-vPro) (MU-MIMO)	L57250-005
<b>(13)</b>	<b>Solid-state drive</b>	
	1 T GB PCIe, NVMeValue	L85370-005
	1 T GB PCIe, NVMe Value Gen 3 × 4 TLC SS	L85348-005
	512 GB M2 2280 PCIe, NVMe Value	L85360-005
	512 GB, PCIe, Gen 3 × 4 TLC SS	L85364-005
	256 GB, PCIe, Gen 3 × 4 TLC SS	L85350-005
	256 GB, PCIe, value	L85354-005
	32 GB/512 GB, PCIe 3DXpoint	L85366-005
	16 GB/256 GB, PCIe 3DXpoint	L85356-005

**Table 3-1 Computer major components and their descriptions (continued)**

Item	Component	Spare part number
<b>(14)</b>	<b>Bottom cover</b>	
	Bottom cover in natural silver finish	L94027-001
	Bottom cover in nightfall black finish	L94028-001
	Bottom cover in pale gold finish	L94026-001

## Display assembly subcomponents

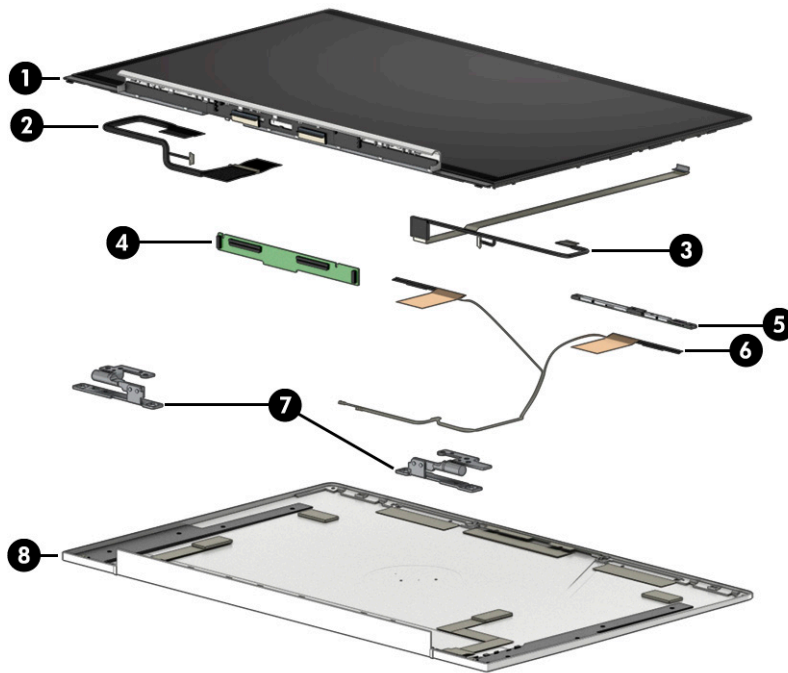
**Table 3-2 Display components and their descriptions**

Item	Component	Spare part number
<b>(1)</b>	<b>Display panel</b>	
	FHD natural silver finish nontouch screen	L96778-001
	FHD pale gold finish nontouch screen	L96779-001
	FHD nightfall black finish nontouch screen	L96780-001
	FHD natural silver finish touch screen	L96781-001
	FHD pale gold finish touch screen	L96782-001
	FHD nightfall black finish touch screen	L96783-001
	FHD natural silver finish nontouch screen	L96784-001
	FHD pale gold finish nontouch screen	L96785-001
	FHD nightfall black finish nontouch screen	L96786-001
	FHD natural silver finish touch screen	L96787-001

**Table 3-2 Display components and their descriptions (continued)**

Item	Component	Spare part number
	FHD pale gold finish touch screen	L96788-001
	FHD nightfall black finish touch screen	L96789-001
	FHD natural silver finish nontouch screen with privacy	L96790-001
	FHD pale gold finish nontouch screen with privacy	L96791-001
	FHD nightfall black finish nontouch screen with privacy	L96792-001
	FHD natural silver finish touch screen with privacy	L96793-001
	FHD pale gold finish touch screen with privacy	L96794-001
	FHD nightfall black finish touch screen with privacy	L96795-001
	UHD natural silver finish touch screen	L96796-001
	UHD pale gold finish touch screen	L96797-001
	UHD nightfall black finish touch screen	L96798-001
<b>(2)</b>	<b>Camera</b>	L94059-001
<b>(3)</b>	<b>Display panel cable</b>	
	Display panel cable for FHD screen	L94071-001
	Display panel cable for UHD screen	L94056-001
<b>(4)</b>	<b>Hinge kit</b>	L94049-001
<b>(5)</b>	<b>Touch screen board</b> (select products only)	L94060-001
<b>(6)</b>	<b>Back cover</b> with antenna	
	<b>NOTE:</b> The antenna that is separate from the back cover is available as spare part number L94057-001.	
	In natural silver finish	L94047-001
	In nightfall black finish	L94048-001
	In pale gold finish	L94046-001

## Mass storage devices



**Table 3-3 Mass storage devices and their descriptions**

Item	Component	Spare part number
<b>(1)</b>	<b>Solid-state drives</b>	
	1 T GB PCIe-NVMe 3 × 4 TLC SS	L85348-005
	1 T GB PCIe-NVMe Value	L85370-005
	512 GB, PCIe, Gen 3 × 4 TLC SS	L85360-005
	512 GB, PCIe, Gen 3 × 4 TLC SS	L85364-005
	256 GB, PCIe, Gen 3 × 4 TLC SS	L85350-005
	256 GB, PCIe, value	L85354-005
	32 GB/512 GB, PCIe-NVMe 3 × 4 TLC SS (Optane memory module/solid-state drive combination drive)	L85366-005
	16 GB, PCIe NVMe Value (Optane memory module)	L85356-005
<b>(2)</b>	<b>USB optical disk drive (external)</b>	747080-005

## Cables

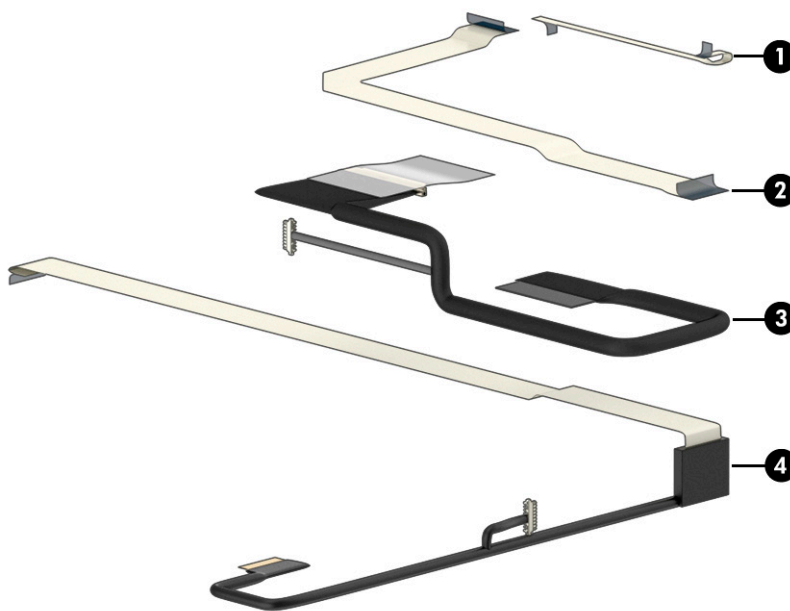
**Table 3-4 Cables and their descriptions**

Component	Spare part number
<b>(1)</b> IR sensor cable	L94040-001
<b>(2)</b> Touchpad cable	L94032-001
<b>(3)</b> Display panel cable	
FHD display panel cable	L94071-001
FHD display panel with privacy cable	L94055-001

**Table 3-4 Cables and their descriptions (continued)**

Component	Spare part number
UHD display cable	L94056-001
<b>(4) Camera cable</b>	
For touch screens	L94053-001
For nontouch screens	L94054-001

## Miscellaneous parts

**Table 3-5 Miscellaneous parts and their descriptions**

Component	Spare part number
<b>AC adapter</b>	
65 W AC adapter (Slim, non-PFC, 4.5 mm, 1.8 m)	L32925-001
65 W AC adapter (Slim, non-PFC, 4.5 mm, 1.8 m)	L24008-001
65 W Smart AC adapter (Slim, non-PFC, 4.5 mm, RC 1.8 m)	913691-850
<b>Power cord (straight, C5, 1.0 m)</b>	
For use in Denmark	L22322-001
For use in Europe	L22321-001
For use in Israel	L22323-001
For use in North America	L22319-001
For use in South Africa	L22325-001
For use in Switzerland	L22324-001
For use in the United Kingdom	L22320-001
For use in Japan	226768-001
	L22330-001
For use in China	L21930-001
For use in Thailand	L22326-001
For use in Australia	L22327-001
For use in Korea	L22328-001
For use in Taiwan	L22329-001
For use in India	L22624-001
For use in Argentina	L30811-001
For use in India	L30813-001
<b>Hub, USB-C-to-Multiport</b>	919666-001
<b>Hub, USB-C to USB-A Hub</b>	916838-001
<b>Hub, HP Elite USB-C Multi Port Hub</b>	L39572-001

**Table 3-5 Miscellaneous parts and their descriptions (continued)**

<b>Component</b>	<b>Spare part number</b>
<b>Adapter, USB to Gigabit RJ45</b>	829941-001
<b>Adapter, USB-C to VGA</b>	831751-001
<b>Adapter, USB-C-to-USB-A</b>	916838-001
<b>Adapter, HP USB-C to RJ45</b>	855560-001
<b>Adapter, USB-C to HDMI 2.0</b>	935325-001
<b>Adapter, USB-C to USB-A cable adapter</b>	833960-001
<b>Screw kit</b>	L94062-001
Rubber kit USB door for natural silver finish	L94030-001
Rubber kit USB door for pale gold finish	L94029-001
Rubber kit USB door for nightfall black finish	L94031-001
Hinge kit	L94049-001

---

# 4 Removal and replacement procedures preliminary requirements

## Tools required

You need the following tools to complete the removal and replacement procedures:

- Tweezers
- Nonconductive, nonmarking pry tool
- Magnetic Phillips P1 screwdriver

## Service considerations

The following sections include some of the considerations that you must keep in mind during disassembly and assembly procedures.



---

**NOTE:** As you remove each subassembly from the computer, place the subassembly (and all accompanying screws) away from the work area to prevent damage.

---

## Plastic parts



---

**IMPORTANT:** Using excessive force during disassembly and reassembly can damage plastic parts.

---

## Cables and connectors



---

**IMPORTANT:**

When servicing the computer, be sure that cables are placed in their proper locations during the reassembly process. Improper cable placement can damage the computer.

---

Cables must be handled with extreme care to avoid damage. Apply only the tension required to unseat or seat the cables during removal and insertion. Handle cables by the connector whenever possible. In all cases, avoid bending, twisting, or tearing cables. Be sure that cables are routed in such a way that they cannot be caught or snagged by parts being removed or replaced. Handle flex cables with extreme care; these cables tear easily.



## Drive handling



**IMPORTANT:** Drives are fragile components that must be handled with care. To prevent damage to the computer, damage to a drive, or loss of information, observe these precautions:

Before removing or inserting a hard drive, shut down the computer. If you are unsure whether the computer is off or in Hibernation, turn the computer on, and then shut it down through the operating system.

Before handling a drive, be sure that you are discharged of static electricity. While handling a drive, avoid touching the connector.

Before removing an optical drive, be sure that a disc is not in the drive and be sure that the optical drive tray is closed.

Handle drives on surfaces covered with at least 2.54 cm (1 inch) of shock-proof foam.

Avoid dropping drives from any height onto any surface.

After removing a hard drive or an optical drive, place it in a static-proof bag.

Avoid exposing an internal hard drive to products that have magnetic fields, such as monitors or speakers.

Avoid exposing a drive to temperature extremes or liquids.

If a drive must be mailed, place the drive in a bubble pack mailer or other suitable form of protective packaging and label the package "FRAGILE."

## Workstation guidelines

Follow these grounding workstation guidelines:

- Cover the workstation with approved static-shielding material.
- Use a wrist strap connected to a properly grounded work surface and use properly grounded tools and equipment.
- Use conductive field service tools, such as cutters, screw drivers, and vacuums.
- When fixtures must directly contact dissipative surfaces, use fixtures made only of static-safe materials.
- Keep the work area free of nonconductive materials, such as ordinary plastic assembly aids and polystyrene foam.
- Handle ESD-sensitive components, parts, and assemblies by the case or PCM laminate. Handle these items only at static-free workstations.
- Avoid contact with pins, leads, or circuitry.
- Turn off power and input signals before inserting or removing connectors or test equipment.

## Electrostatic discharge information

A sudden discharge of static electricity from your finger or other conductor can destroy static-sensitive devices or microcircuitry. Often the spark is neither felt nor heard, but damage occurs. An electronic device exposed to electrostatic discharge (ESD) might not appear to be affected at all and can work perfectly throughout a normal cycle. The device might function normally for a while, but it has been degraded in the internal layers, reducing its life expectancy.

Networks built into many integrated circuits provide some protection, but in many cases, the discharge contains enough power to alter device parameters or melt silicon junctions.



**IMPORTANT:** To prevent damage to the device when you are removing or installing internal components, observe these precautions:

Keep components in their electrostatic-safe containers until you are ready to install them.

Before touching an electronic component, discharge static electricity by using the guidelines described in this section.

Avoid touching pins, leads, and circuitry. Handle electronic components as little as possible.

If you remove a component, place it in an electrostatic-safe container.

## Generating static electricity

Note the following:

- Different activities generate different amounts of static electricity.
- Static electricity increases as humidity decreases.

**Table 4-1 Static electricity occurrence based on activity and humidity**

Event	Relative humidity		
	55%	40%	10%
Walking across carpet	7,500 V	15,000 V	35,000 V
Walking across vinyl floor	3,000 V	5,000 V	12,000 V
Motions of bench worker	400 V	800 V	6,000 V
Removing DIPs (dual in-line packages) from plastic tube	400 V	700 V	2,000 V
Removing DIPs from vinyl tray	2,000 V	4,000 V	11,500 V
Removing DIPs from polystyrene foam	3,500 V	5,000 V	14,500 V
Removing bubble pack from PCB (printed circuit board)	7,000 V	20,000 V	26,500 V
Packing PCBs in foam-lined box	5,000 V	11,000 V	21,000 V

Multiple electric components can be packaged together in plastic tubes, trays, or polystyrene foam.



**NOTE:** As little as 700 V can degrade a product.

## Preventing electrostatic damage to equipment

Many electronic components are sensitive to ESD. Circuitry design and structure determine the degree of sensitivity. The following packaging and grounding precautions are necessary to prevent static electricity damage to electronic components.

- To avoid hand contact, transport products in static-safe containers such as tubes, bags, or boxes.
- Protect all electrostatic parts and assemblies with conductive or approved containers or packaging.
- Keep electrostatic-sensitive parts in their containers until they arrive at static-free stations.
- Place items on a grounded surface before removing them from their container.
- Always be properly grounded when touching a sensitive component or assembly.

- Avoid contact with pins, leads, or circuitry.
- Place reusable electrostatic-sensitive parts from assemblies in protective packaging or conductive foam.

## Personal grounding methods and equipment

Use the following equipment to prevent static electricity damage to electronic components:

- **Wrist straps** are flexible straps with a maximum of  $1\text{ M}\Omega \pm 10\%$  resistance in the ground cords. To provide proper ground, a strap must be worn snug against bare skin. The ground cord must be connected and fit snugly into the banana plug connector on the grounding mat or workstation.
- **Heel straps/Toe straps/Boot straps** can be used at standing workstations and are compatible with most types of shoes or boots. On conductive floors or dissipative floor mats, use them on both feet with a maximum of  $1\text{ M}\Omega \pm 10\%$  resistance between the operator and ground.

**Table 4-2 Static shielding protection levels**

Static shielding protection levels	
Method	Voltage
Antistatic plastic	1,500
Carbon-loaded plastic	7,500
Metallized laminate	15,000

## Grounding the work area

To prevent static damage at the work area, use the following precautions:

- Cover the work surface with approved static-dissipative material. Provide a wrist strap connected to the work surface and properly grounded tools and equipment.
- Use static-dissipative mats, foot straps, or air ionizers to give added protection.
- Handle electrostatic sensitive components, parts, and assemblies by the case or PCB laminate. Handle them only at static-free work areas.
- Turn off power and input signals before inserting and removing connectors or test equipment.
- Use fixtures made of static-safe materials when fixtures must directly contact dissipative surfaces.
- Keep work area free of nonconductive materials such as ordinary plastic assembly aids and polystyrene foam.
- Use field service tools, such as cutters, screwdrivers, and vacuums, that are conductive.

## Recommended materials and equipment

HP recommends the following materials and equipment to prevent static electricity:

- Antistatic tape
- Antistatic smocks, aprons, or sleeve protectors
- Conductive bins and other assembly or soldering aids
- Conductive foam
- Conductive tabletop workstations with ground cord of  $1\text{ M}\Omega \pm 10\%$  resistance

- Static-dissipative table or floor mats with hard tie to ground
- Field service kits
- Static awareness labels
- Wrist straps and footwear straps providing  $1\text{ M}\Omega \pm 10\%$  resistance
- Material handling packages
- Conductive plastic bags
- Conductive plastic tubes
- Conductive tote boxes
- Opaque shielding bags
- Transparent metallized shielding bags
- Transparent shielding tubes

## Packaging and transporting guidelines

Follow these grounding guidelines when packaging and transporting equipment:

- To avoid hand contact, transport products in static-safe tubes, bags, or boxes.
- Protect ESD-sensitive parts and assemblies with conductive or approved containers or packaging.
- Keep ESD-sensitive parts in their containers until the parts arrive at static-free workstations.
- Place items on a grounded surface before removing items from their containers.
- Always be properly grounded when touching a component or assembly.
- Store reusable ESD-sensitive parts from assemblies in protective packaging or nonconductive foam.
- Use transporters and conveyors made of antistatic belts and roller bushings. Be sure that mechanized equipment used for moving materials is wired to ground and that proper materials are selected to avoid static charging. When grounding is not possible, use an ionizer to dissipate electric charges.

---

# 5 Removal and replacement procedures for authorized service provider parts

---

 **IMPORTANT:** Components described in this chapter should be accessed by an authorized service provider. Accessing these parts can damage the computer or void the warranty.

 **NOTE:** HP continually improves and changes product parts. For complete and current information about supported parts for your computer, go to <http://partsurfer.hp.com>, select your country or region, and then follow the on-screen instructions.

---

## Component replacement procedures

There are as many as 52 screws that must be removed, replaced, or loosened when servicing the parts described in this chapter. Make special note of each screw size and location during removal and replacement.

### Preparation for disassembly

See [Removal and replacement procedures preliminary requirements on page 32](#) for initial safety procedures.

1. Turn off the computer. If you are unsure whether the computer is off or in Hibernation, turn the computer on, and then shut it down through the operating system.
2. Disconnect the power from the computer by unplugging the power cord from the computer.
3. Disconnect all external devices from the computer.

## Bottom cover and rubber feet

**Table 5-1 Bottom cover and rubber feet descriptions and part numbers**

Description	Spare part number
Bottom cover in pale gold finish	L94026-001
Bottom cover in natural silver finish	L94027-001
Bottom cover in nightfall black finish	L94028-001
Rubber foot kit for natural silver finish	L94024-001
Rubber foot kit for nightfall black finish	L94025-001
Rubber foot kit for pale gold finish	L94023-001

- ▲ Prepare the computer for disassembly ([Preparation for disassembly on page 37](#)).

To remove the bottom cover and rubber feet:

1. Peel the one rubber foot off the bottom of the computer **(1)**.
2. Remove the two Phillips M2.5 × 5.0 screws from the rear of the computer **(2)**.
3. Remove the two Phillips M2.5 × 5.0 screws from the front of the computer **(3)**, and then remove the bottom cover **(4)**.

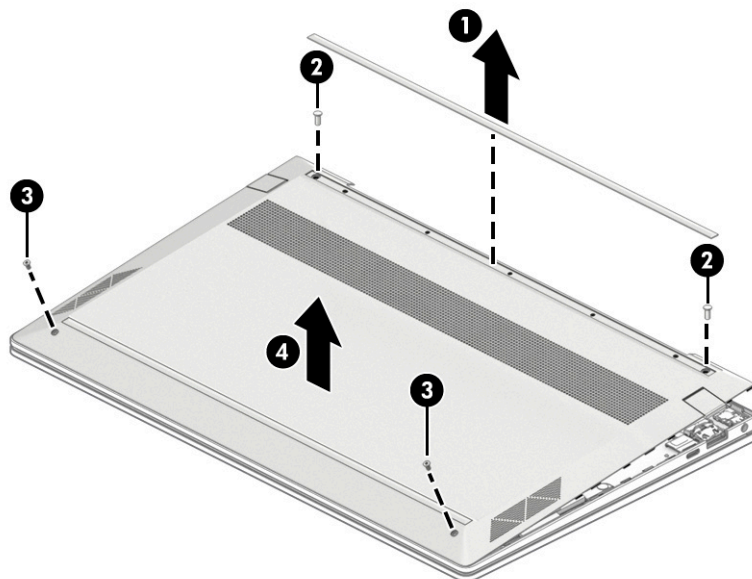

Reverse this procedure to install the bottom cover and rubber feet.

## Battery

**Table 5-2 Battery description and part number**

Description	Spare part number
Battery (3 cell, 51 Whr)	L77034-005

Before removing the battery, follow these steps:

1. Prepare the computer for disassembly ([Preparation for disassembly on page 37](#)).
2. Remove the bottom cover (see [Bottom cover and rubber feet on page 38](#)).

To remove the battery:

1. Disconnect the battery cable from the computer **(1)**.
2. Remove the six Phillips M2.0 × 6.0 screws **(2)** that secure the battery to the computer.
3. Remove the battery from the computer **(3)**.

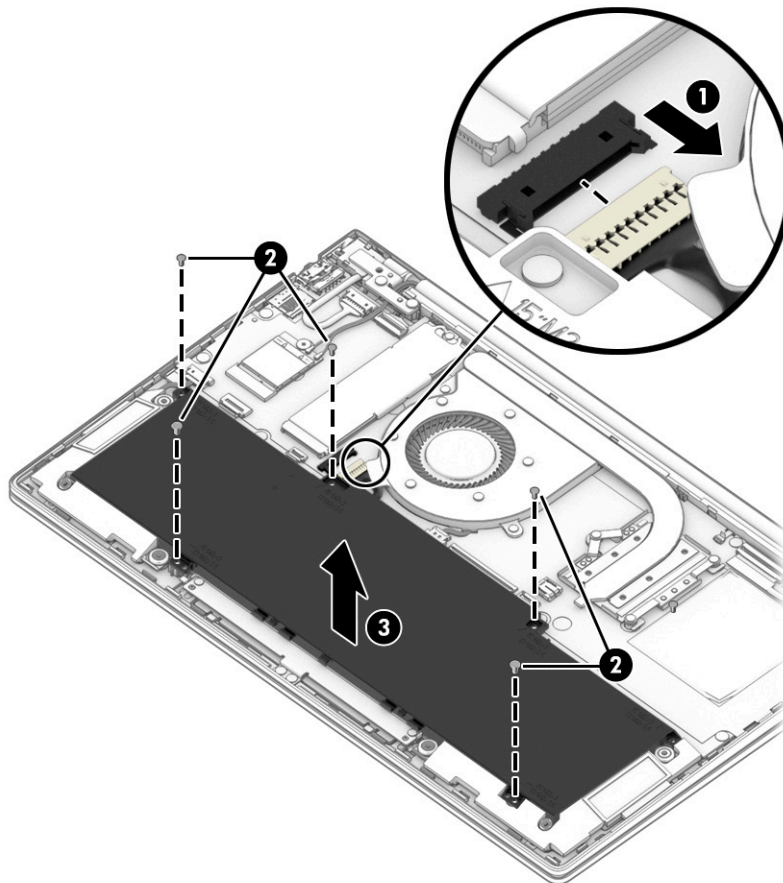

Reverse this procedure to install the battery.

## Touchpad

 **NOTE:** The touchpad spare part kit does not include the touchpad cable. The touchpad cable is available using spare part number L87955-001. Touchpads that are included with keyboard/top covers with wood veneer cannot be replaced.

**Table 5-3 Touchpad description and part number**

Description	Spare part number
Touchpad in pale gold finish	L94033-001
Touchpad in natural silver finish	L94034-001
Touchpad cable	L94032-001

Before removing the touchpad, follow these steps:

1. Prepare the computer for disassembly ([Preparation for disassembly on page 37](#)).
2. Remove the bottom cover (see [Bottom cover and rubber feet on page 38](#)).
3. Remove the battery (see [Battery on page 39](#)).

To remove the touchpad:

1. Disconnect the touchpad cable from the touchpad connector on the system board **(1)**.
2. Remove the two Phillips M1.6 × 3.0 screws **(2)** and the two Phillips M1.6 × 2.0 screws **(3)** that secure the touchpad bracket to the computer.
3. Remove the touchpad bracket from the computer **(4)**.
4. Remove the three broadhead Phillips M1.6 × 2.5 screws **(5)** that secure the touchpad to the computer.
5. Remove the touchpad from the computer **(6)**.

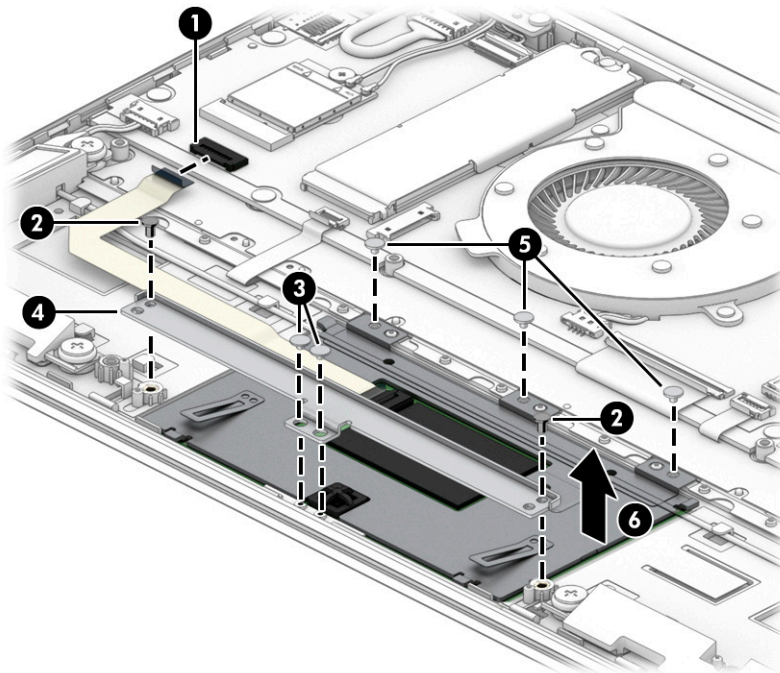



Reverse this procedure to install the touchpad.

## Speakers

**Table 5-4 Speaker description and part number**

Description	Spare part number
Speakers (includes left and right speakers and cables)	L94045-001

Before removing the speakers, follow these steps:

1. Prepare the computer for disassembly ([Preparation for disassembly on page 37](#)).
2. Remove the bottom cover (see [Bottom cover and rubber feet on page 38](#)).
3. Remove the battery (see [Battery on page 39](#)).
4. Remove the touchpad (see [Touchpad on page 40](#)).

To remove the speakers:

1. Disconnect the speaker cable (1).
2. Remove the four Phillips M2.0× 2.0 screws that secure the speakers to the computer.
3. Detach the left and right speaker cables from the clips holding them (3).
4. Remove the speaker assembly (4).

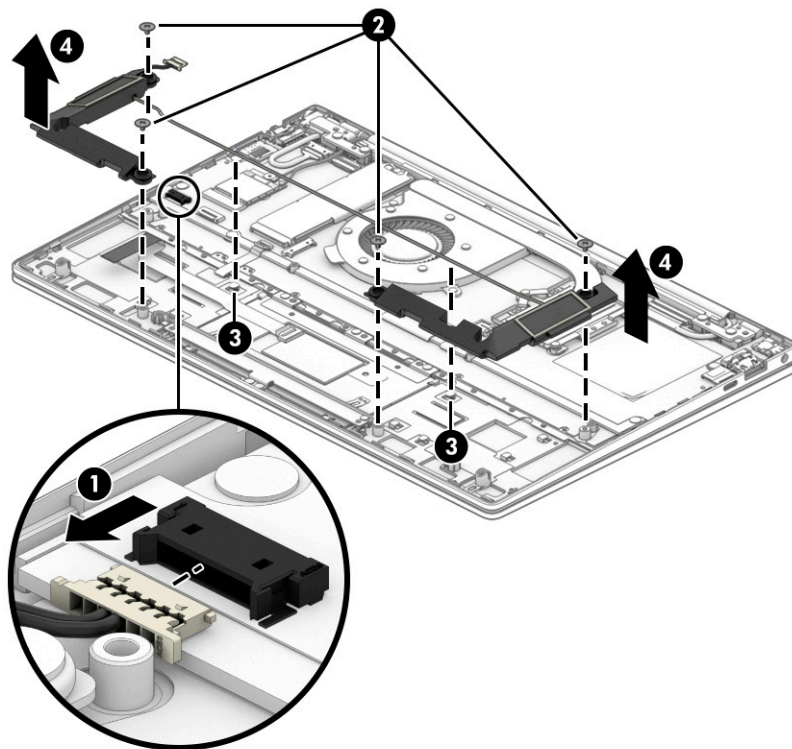

Reverse this procedure to install the speakers.

## Solid-state drive and Optane Memory Module

**Table 5-5 Solid-state drive descriptions and part numbers**

Description	Spare part number
512 GB, PCIe, Gen 3 × 4	L85360-005
512 GB, PCIe, value	L85364-005
256 GB, PCIe, Gen 3 × 4	L85350-005
256 GB, PCIe	L85354-005
128 GB, SATA-3, TLC	L85346-005
32 GB/512 GB, PCIe (Optane memory module/solid-state drive combination drive)	L85366-005
16 GB PCIe (Optane memory module/solid-state drive combination drive)	L85372-005
1 TB M2 2280 PCIe-NVMe Value	L85370-005
1 TB M2 2280 PCIe-NVMe 3 × 4 TLC SS	L85348-005

Before removing the solid-state drive, follow these steps:

1. Prepare the computer for disassembly ([Preparation for disassembly on page 37](#)).
2. Remove the bottom cover (see [Bottom cover and rubber feet on page 38](#)).
3. Remove the battery (see [Battery on page 39](#)).

To remove the solid-state drive:



**NOTE:** On select products, the size and shape of the Mylar cover may vary from the illustration.

1. Pull back the Mylar cover to access the solid-state drive bracket **(1)**.

2. Remove the screw securing the solid-state drive bracket to the computer **(2)** and then remove the solid-state drive bracket **(3)**.

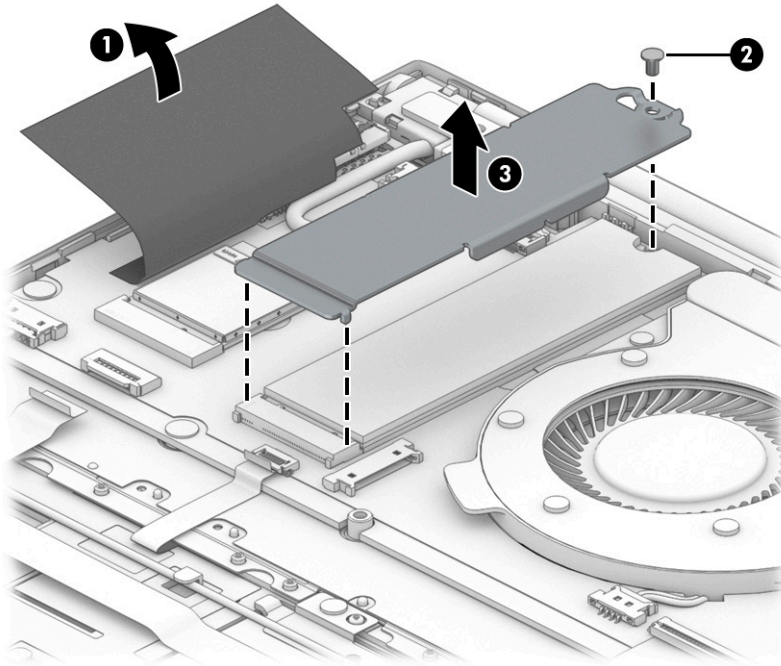

3. Remove the Phillips M2.0 × 3.0 screw **(1)**, lift the solid-state drive module bracket and pull the solid-state drive module from the socket **(2)**.

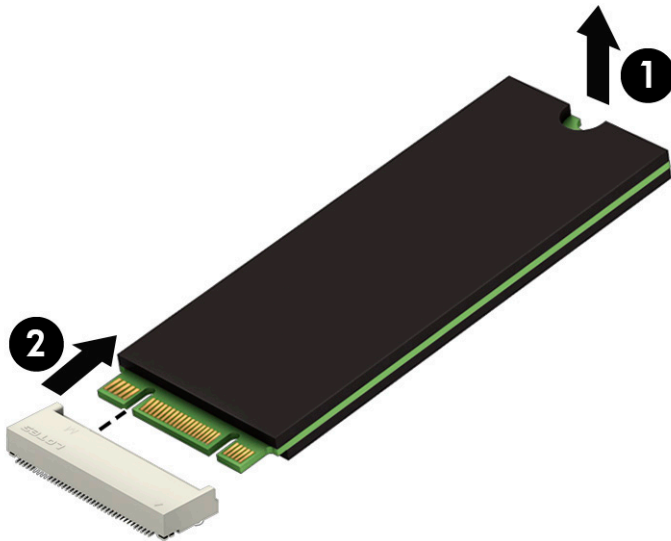



Reverse this procedure to install the solid-state drive.

## WLAN module

**Table 5-6 WLAN module description and part number**

Description	Spare part number
Intel Wireless-AC 2230 802.11ac 2 × 2 Wi-Fi + Bluetooth 5	L57250-005

 **IMPORTANT:** To prevent an unresponsive system, replace the wireless module only with a wireless module authorized for use in the computer by the governmental agency that regulates wireless devices in your country or region. If you replace the module and then receive a warning message, remove the module to restore device functionality, and then contact technical support.

 **NOTE:** On select products, the WLAN module cannot be removed or replaced. Before you begin this process, check that the WLAN module can be removed or replaced on your model.

Before removing the WLAN module, follow these steps:

1. Prepare the computer for disassembly ([Preparation for disassembly on page 37](#)).
2. Remove the bottom cover (see [Bottom cover and rubber feet on page 38](#)).
3. Remove the battery (see [Battery on page 39](#)).

To remove the WLAN module:

 **NOTE:** On select products, the size and shape of the Mylar cover may vary from the illustration.

1. Pull back the Mylar cover to access the WLAN module **(1)**.
2. Disconnect the WLAN antenna cables **(2)** from the terminals on the WLAN module.

 **NOTE:** Models have either one or two WLAN antennas. On models with two antennas, the #1/white WLAN antenna cable connects to the WLAN module #1/Main terminal. The #2/black WLAN antenna cable connects to the WLAN module #1/Aux terminal.

3. Remove the Phillips M2.0 × 3.0 screw **(3)** that secures the WLAN module to the computer. (The WLAN module tilts up.)

4. Remove the WLAN module (4) by pulling the module away from the slot at an angle.

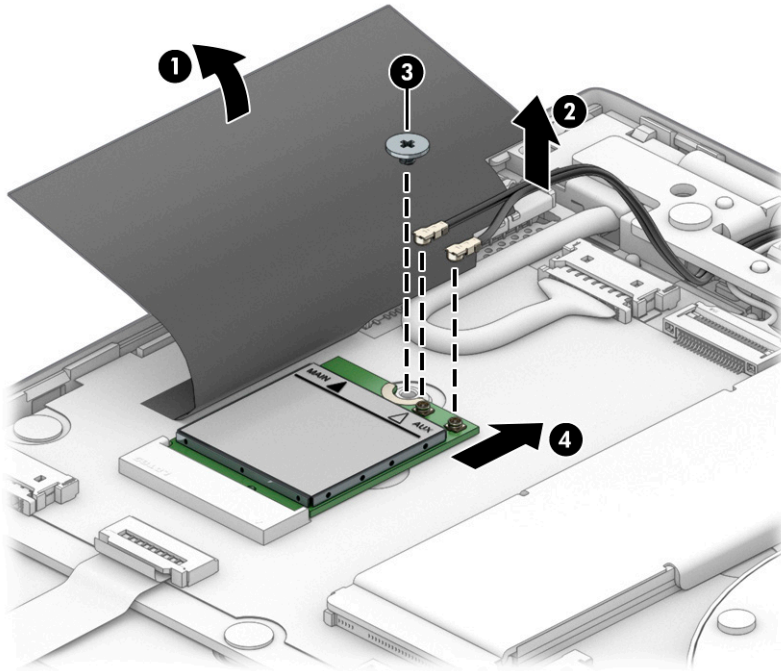

Reverse this procedure to install the WLAN module.

# Fan

**Table 5-7 Fan description and part number**

Description	Spare part number
Fan	L94043-001

Before removing the fan, follow these steps:

1. Prepare the computer for disassembly ([Preparation for disassembly on page 37](#)).
2. Remove the bottom cover (see [Bottom cover and rubber feet on page 38](#)).
3. Remove the battery (see [Battery on page 39](#)).

To remove the fan:

 **NOTE:** On select products, the size and shape of the Mylar cover may vary from the illustration.

1. Pull back the Mylar cover to access the fan **(1)**.
2. Disconnect the fan cable from the system board **(2)**.
3. Remove the two Phillips M2.0 × 2.0 screws **(3)** that secure the fan to the computer.
4. Remove the fan from the computer **(4)**.

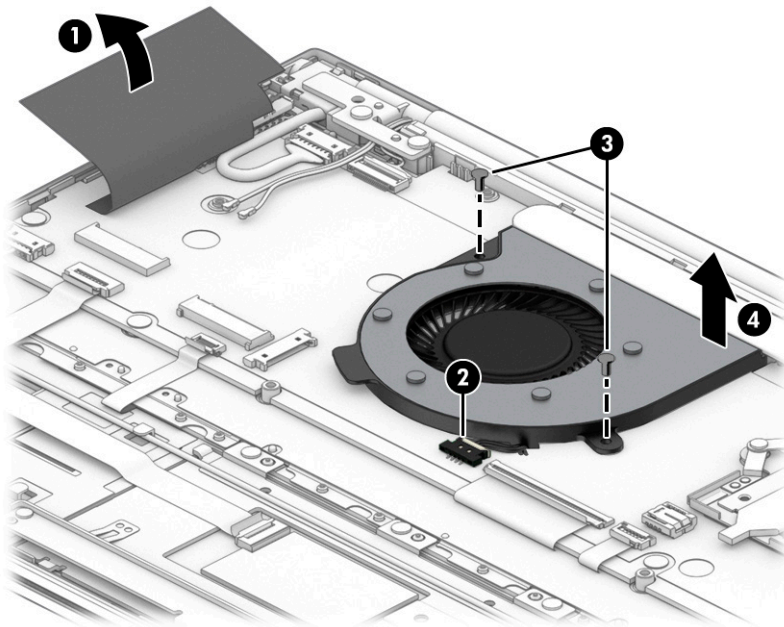

Reverse this procedure to install the fan.

## Heat sink

**Table 5-8 Heat sink and thermal pad descriptions and part numbers**

Description	Spare part number
Heat sink — UMA	L94042-001
Heat sink — discrete	L94041-001

Before removing the heat sink, follow these steps:

1. Prepare the computer for disassembly ([Preparation for disassembly on page 37](#)).
2. Remove the bottom cover (see [Bottom cover and rubber feet on page 38](#)).
3. Remove the battery (see [Battery on page 39](#)).
4. Remove the fan.

Remove the heat sink on models with discrete graphics:

1. Remove the six Phillips M2.0 × 3.0 screws **(1)** that secure the heat sink to the system board.
2. Remove the heat sink **(2)**.

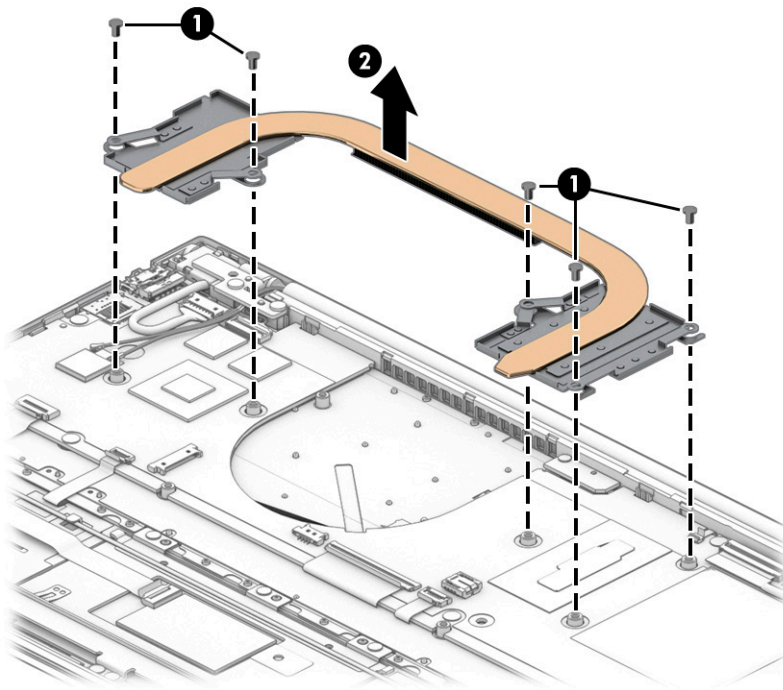

Remove the heat sink on models with UMA graphics:

1. Remove the three Phillips M2.0 × 2.0 screws **(1)** that secure the heat sink to the system board.



2. Remove the heat sink.

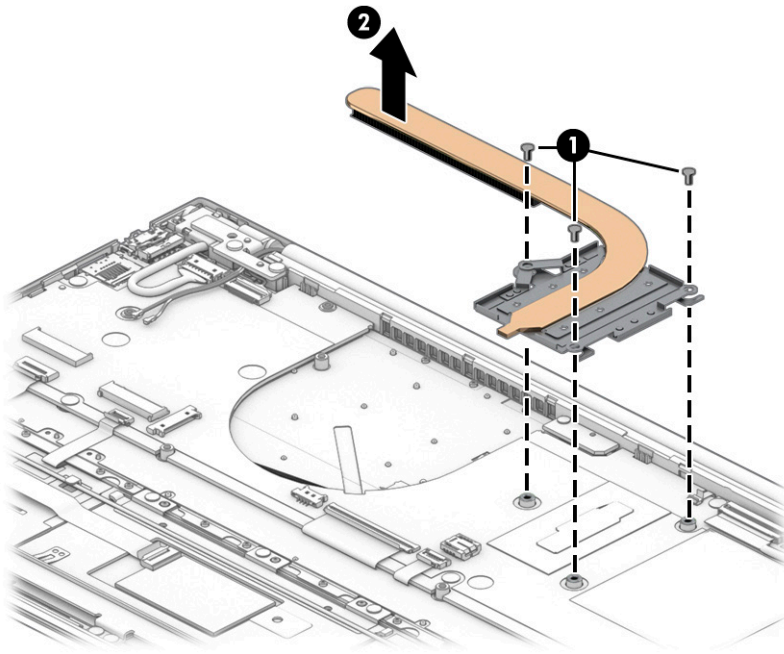

Reverse this procedure to install the heat sink.

## System board

**Table 5-9 System board descriptions and part numbers**

Description	Spare part number
System board including integrated Intel Core i7-1051 U processor and 16 GB of discrete graphics memory	L94594-601
System board including integrated Intel Core i7-1051 U processor and 8 GB of discrete graphics memory	L94593-601
System board including integrated Intel Core i7-1065 G7 processor and 8 GB of UMA graphics memory	L94591-601
System board including integrated Intel Core i5-1021 U processor and 8 GB of discrete graphics memory	L94592-601
System board including integrated Intel Core i5-1035 G4 processor and 8 GB of UMA graphics memory	L94590-601
System board including integrated Intel Core i5-1035 G1 processor and 8 GB of UMA graphics memory	L94589-601

Before removing the system board, follow these steps:

1. Prepare the computer for disassembly ([Preparation for disassembly on page 37](#)).
2. Remove the bottom cover (see [Bottom cover and rubber feet on page 38](#)).
3. Remove the battery (see [Battery on page 39](#)).
4. Remove the solid-state drive (see [Solid-state drive and Optane Memory Module on page 43](#)).

To remove the system board:

1. Disconnect the following cables from the system board. If necessary, pull back the Mylar cover to access specific cables.



**NOTE:** On select products, the size and shape of the Mylar cover may vary from the illustration.

- (1) Mylar cover
- (2) Power connector cable
- (3) Camera cable
- (4) Display cable
- (5) Backlight cable
- (6) Keyboard cable
- (7) WLAN antenna cable
- (8) Fingerprint reader cable
- (9) Touchpad cable
- (10) Speaker cable

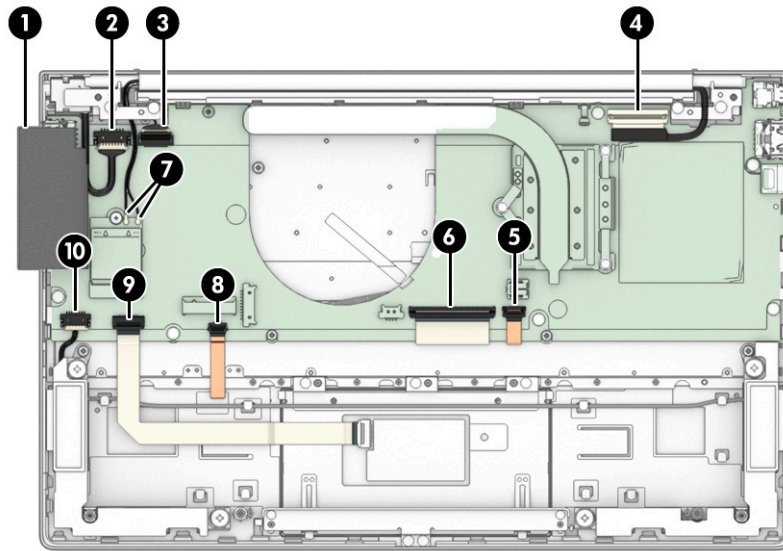

2. Remove the three Phillips M2.0 × 3.0 screws **(1)**, and then remove the USB Type C bracket securing the system board **(2)**.
3. Remove the four M2.0 × 3.0 screws securing the system board **(3)**.

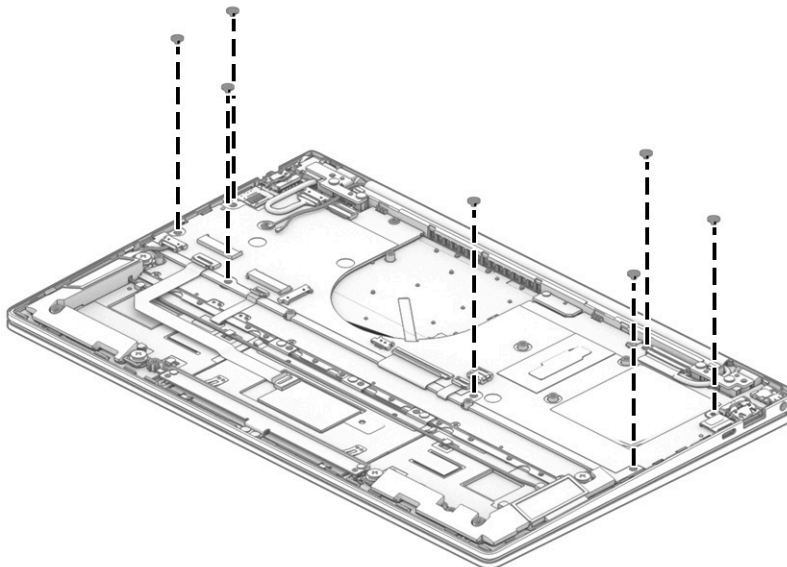

- ▲ Lift the system board **(1)**, and then remove the board **(2)**.

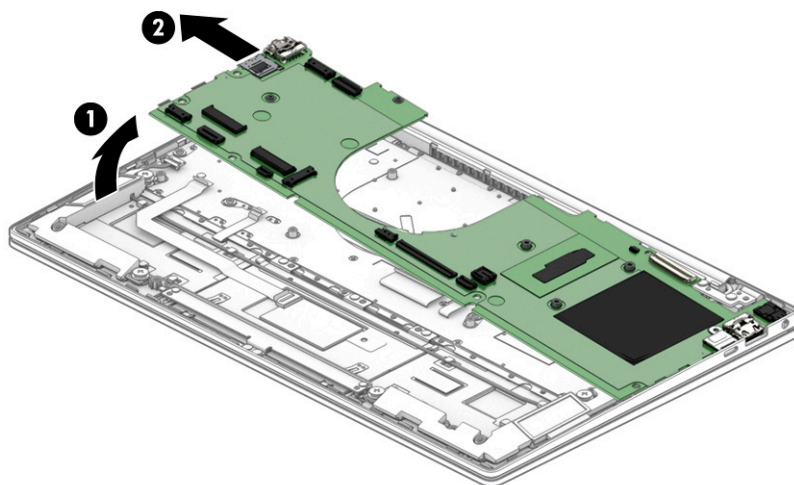

Reverse this procedure to install the system board.

## IR sensor board

Description	Spare part number
IR sensor board	L94039-001
IR sensor board cable	L94040-001

Before removing the IR sensor board, follow these steps:

1. Prepare the computer for disassembly ([Preparation for disassembly on page 37](#)).
2. Remove the bottom cover (see [Bottom cover and rubber feet on page 38](#)).
3. Remove the battery (see [Battery on page 39](#)).
4. Remove the heat sink (see [Heat sink on page 48](#)).
5. Remove the system board (see [System board on page 50](#)).

To remove the IR sensor board::

1. Remove the IR sensor board M2.0 × 1.0 screw from the IR board **(1)**.

2. Remove the IR board from the computer (2).

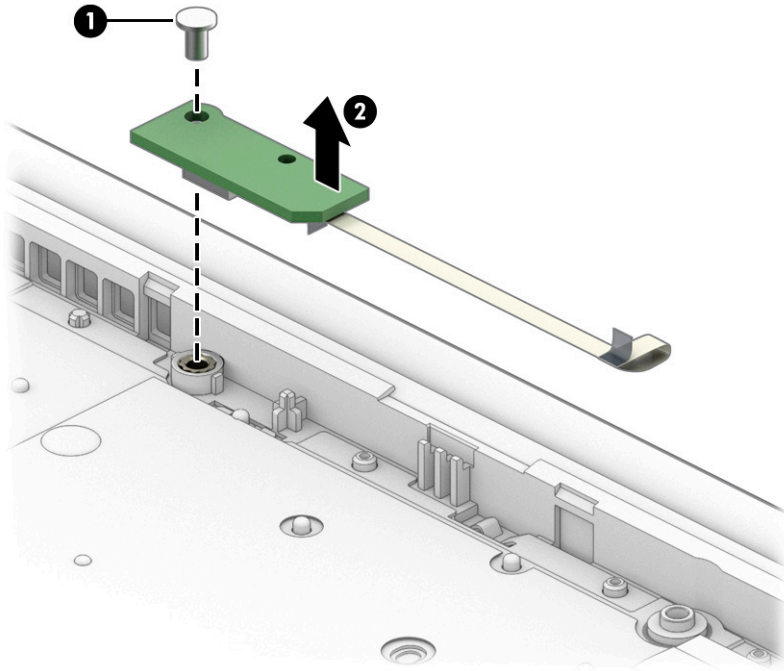

Reverse this procedure to install the IR sensor board.

## Display assembly

**Table 5-10 Display assembly descriptions and part numbers**

Description	Spare part number
Full High Definition (FHD) natural silver finish, touch screen	L96778-001
FHD pale gold finish touch screen	L96779-001
FHD, nightfall black finish touch screen	L96780-001
FHD natural silver finish touch screen	L96781-001
FHD, pale gold finish touch screen	L96782-001
FHD, nightfall black finish touch screen	L96783-001
FHD, natural silver finish touch screen	L96784-001
FHD, pale gold finish touch screen	L96785-001
FHD, nightfall black finish touch screen	L96786-001
FHD, natural silver finish touch screen	L96787-001
FHD, pale gold finish touch screen	L96788-001
FHD, nightfall black finish touch screen	L96789-001
FHD, natural silver finish nontouch screen with privacy	L96790-001
FHD pale gold finish nontouch screen with privacy	L96791-001
FHD, nightfall black finish nontouch screen with privacy	L96792-001
FHD, natural silver finish touch screen with privacy	L96793-001
FHD, pale gold finish touch screen with privacy	L96794-001
FHD, nightfall black finish touch screen with privacy	L96795-001
UHD, natural silver finish touch screen	L96796-001
FHD, pale gold finish touch screen	L96797-001
Display assembly, FHD, nightfall black finish touch screen	L96798-001

Before removing the display assembly, follow these steps:

1. Prepare the computer for disassembly ([Preparation for disassembly on page 37](#)).
2. Remove the bottom cover (see [Bottom cover and rubber feet on page 38](#)).
3. Remove the battery (see [Battery on page 39](#)).

To remove the display assembly:

1. Remove the WLAN antennas and camera cable from the clips and channel in the right speaker and computer **(1)**.
2. Remove the display panel cable from the routing channel in the left speaker **(2)**.

3. Disconnect the display panel cable on the right side **(3)** and remove the cable **(4)**.

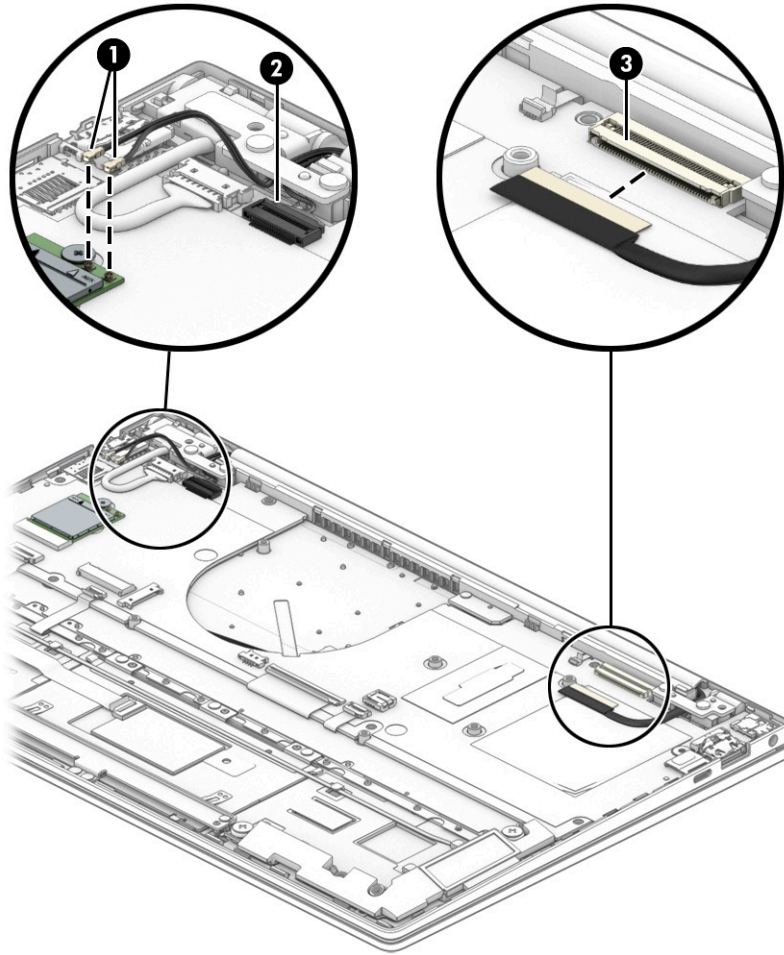

4. Remove the two Phillips M2.0 × 3.0 screws **(1)** from each hinge.
5. Open the display to open the hinges **(2)**.

6. Separate the display from the computer by pulling the display up and away from the chassis (3).

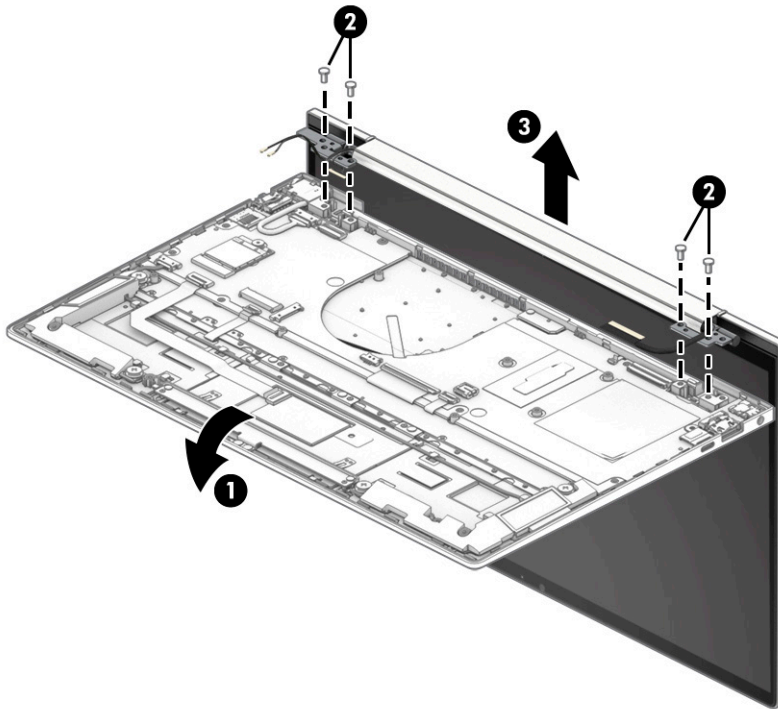

Reverse this procedure to install the display assembly.

7. Position two suction cup tools at the illustrated location on the display panel (1) and then rotate each locking lever down to lock the cup (2).

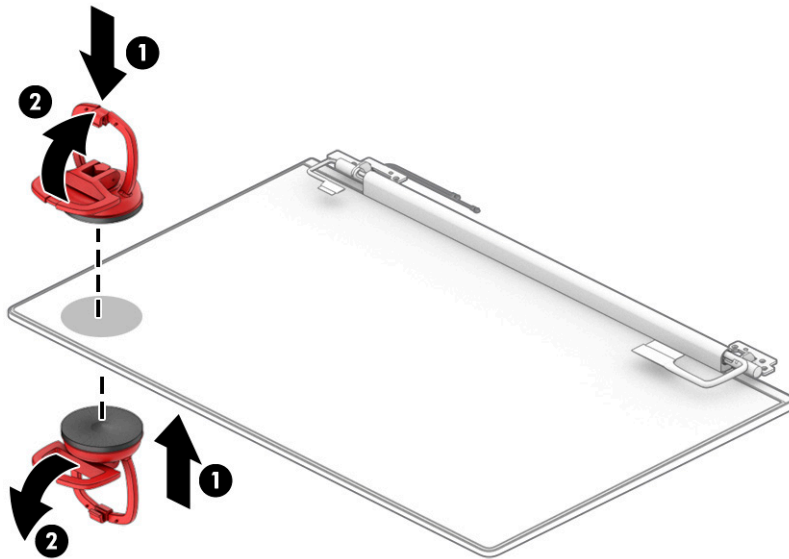



8. Pull the suction tool handle to disengage the panel from the computer **(1)**. If it is necessary to remove or replace the panel, note that the display panel is secured to the display enclosure with tape that is installed under the left and right sides of the panel. Use tweezers to grasp the end of the tape **(2)**. While turning the tweezers, wrap the tape around the tweezers **(3)** as you continue to pull the tape out from behind the display panel. You must pull the tape multiple times before it is completely removed. Remove the panel **(4)**.

 **IMPORTANT:** If the tape tears, do not attempt to pry the panel off the enclosure. Doing so might break the panel.

To avoid tearing the tape, do not pull on it with the sharp end of tweezers.

 **NOTE:** To fully remove the panel, repeat the above procedure on the other side. Be sure not to use suction cups in the middle to avoid damaging the camera module.

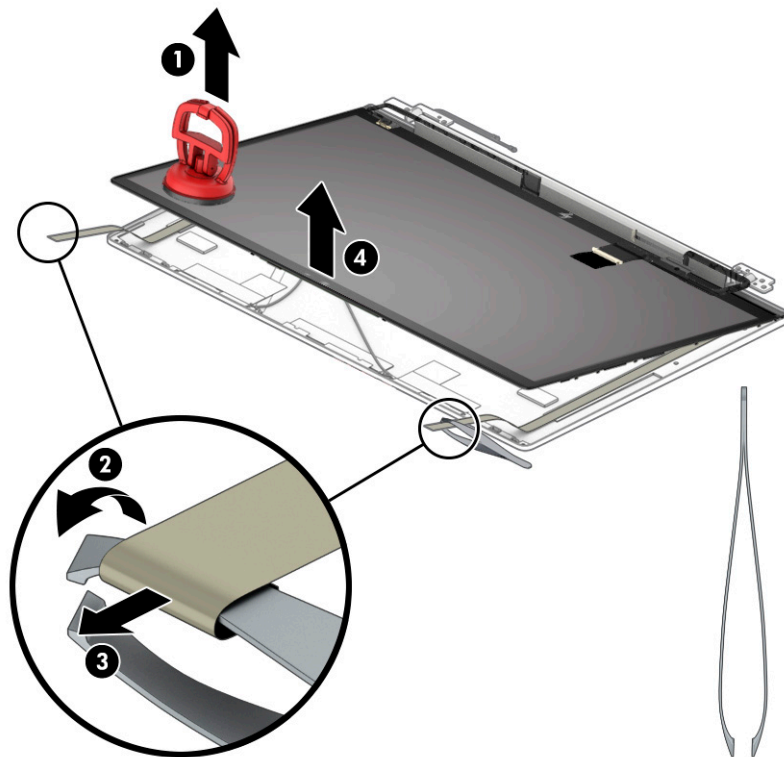

9. Use the following steps to install a display panel:
  - a. Download and install the touch panel firmware when you replace the touch screen board or touch panel. Download the correct calibration firmware file based on your panel specification. For more information, see HP Help and Support.
  - b. Peel the bottom nonstick backing off the double-sided tape **(1)**.
  - c. Add the double-sided tape to the rear of the display panel cover **(2)**.

- d. Peel the top nonstick backing off the double-sided tape so it can be secured to the rear **(3)**.

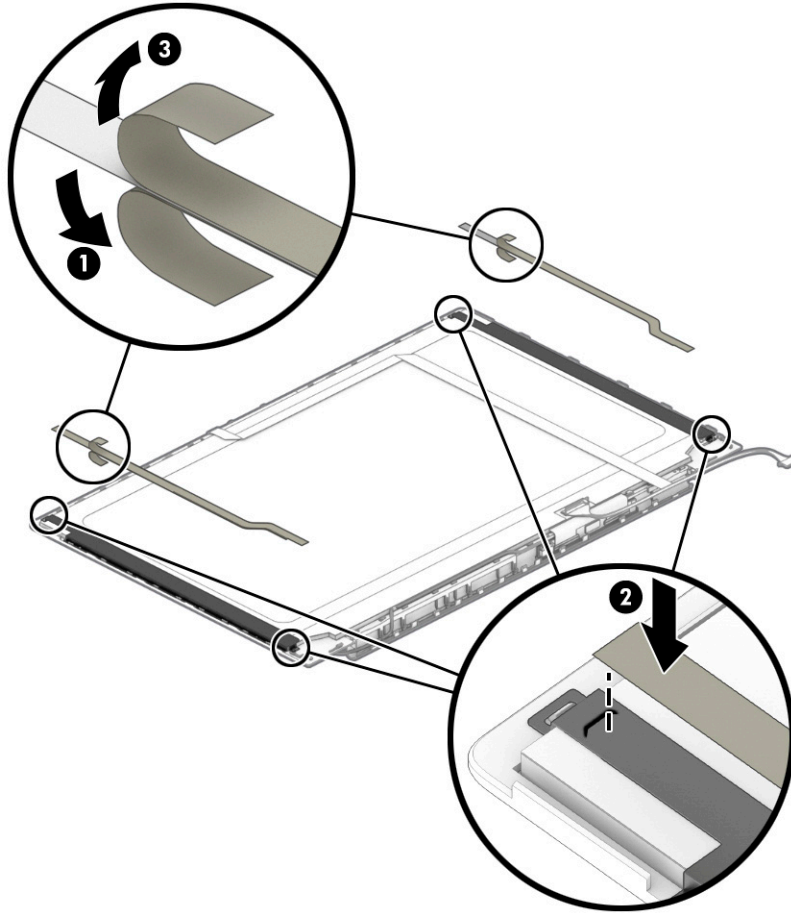

- e. Place the panel on top of the display panel cover **(1)**, and then press the panel down to secure it to the display enclosure **(2)**.

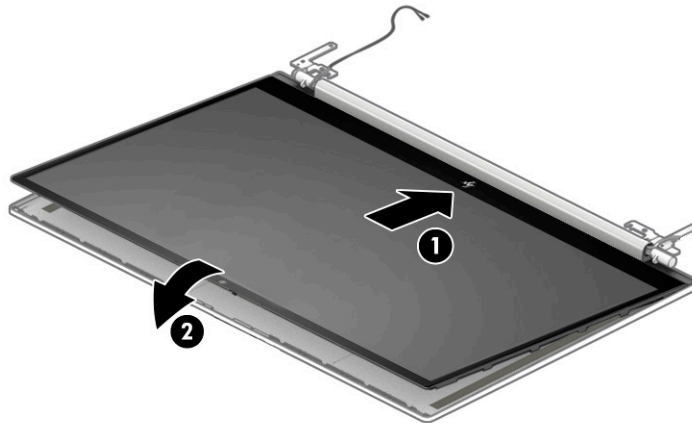

10. If it is necessary to remove or replace the camera, peel back the tape (1) and disconnect the camera cable from the connector (2). Locate the display cable locations (3). Use a plastic tool to pull the camera from the display panel cover (4), and then remove the camera (5).

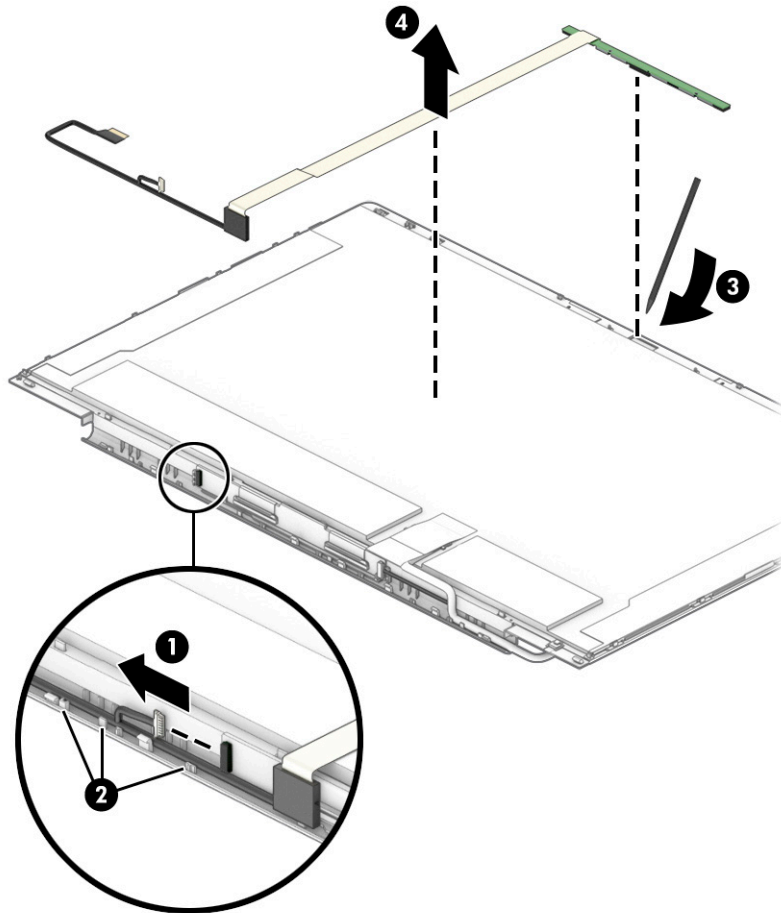

To release the camera cable from the camera connector, lift the release arm on the camera connector securing the camera cable to the connector (1), and then release the camera cable (2).

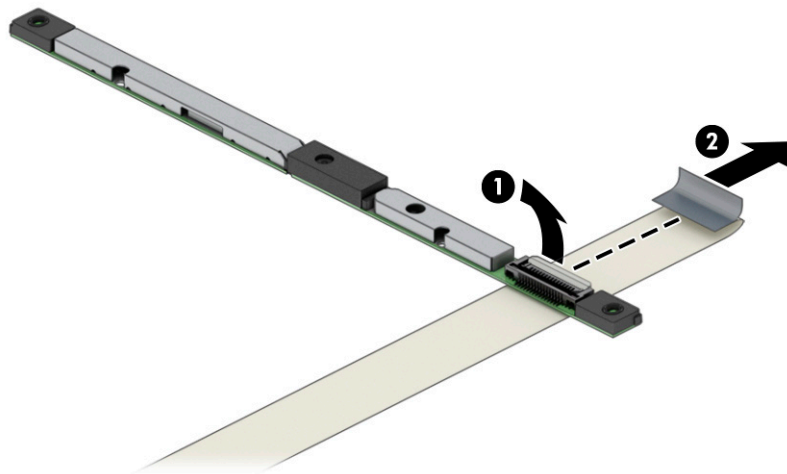

Reverse this procedure to install the camera and the camera cable.

The camera is available as spare part number L87982-001.

11. If it is necessary to remove or replace the touch screen board, remove the touch screen board cable from the touch screen board on the display assembly (1), and then remove both touch screen cables from the touch screen board (2). Release the adhesive tape from the touch screen board (3), and then remove the touch screen board after releasing it from the clips securing it.

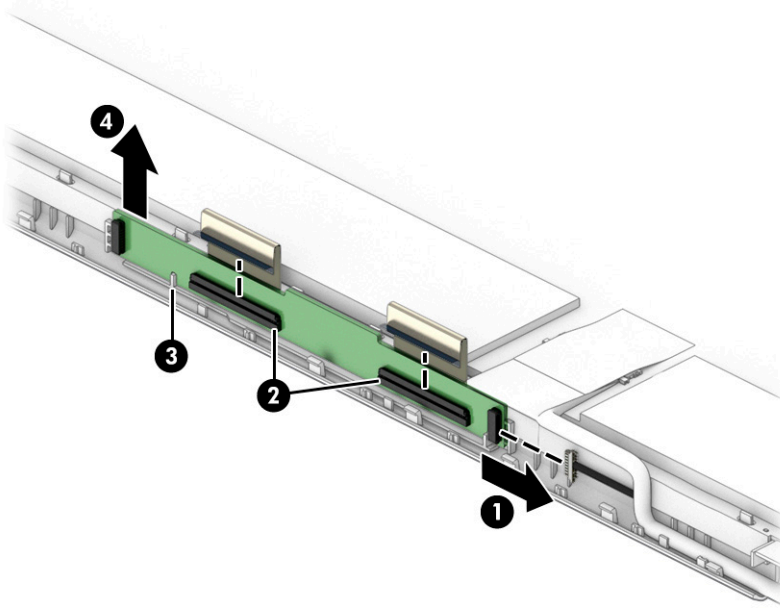

The touch screen board is available as spare part number L87966-001 and the touch screen board cable is available as spare part number L87956-001. The touch screen board is included in the touch panel kit.

12. If it is necessary to remove or replace the antenna, detach the auxiliary antenna **(1)** from the adhesive securing it to the display panel enclosure. Remove the main antenna **(2)**, and disengage the cable from the clips that secure the antenna cable to the display enclosure **(3)**.

The separate antenna is available as spare part number L94057-001. The antenna that is included with the back cover is available in natural silver finish (L94046-001), in nightfall black finish (L94046-001), and pale gold finish (L94046-001).

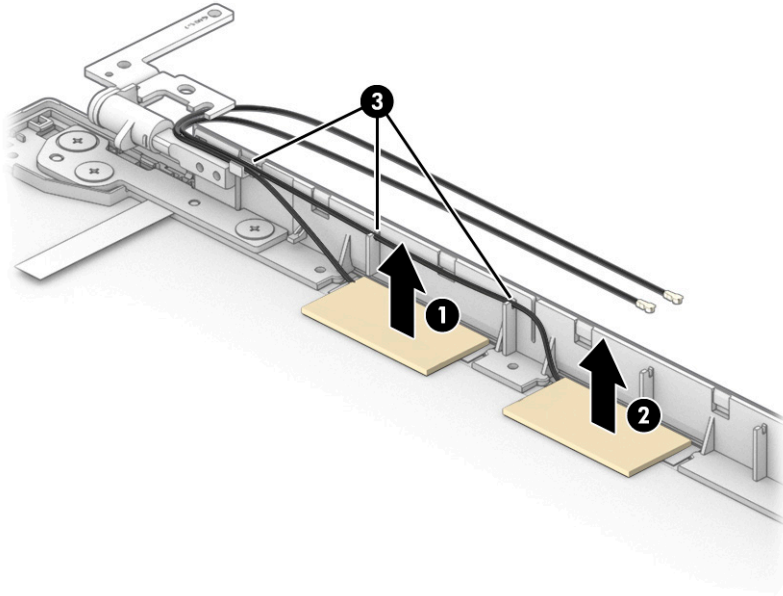

## Power connector

**Table 5-11 Power connector description and part number**

Description	Spare part number
Power connector	L94044-001

Before removing the power connector cable, follow these steps:

1. Prepare the computer for disassembly ([Preparation for disassembly on page 37](#)).
2. Remove the bottom cover (see [Bottom cover and rubber feet on page 38](#)).
3. Remove the battery (see [Battery on page 39](#)).

To remove the power connector:

1. Pull back the Mylar cover to access the power connector **(1)**.
2. Remove the cable **(2)**.
3. Remove the power connector and cable from the computer **(3)**.

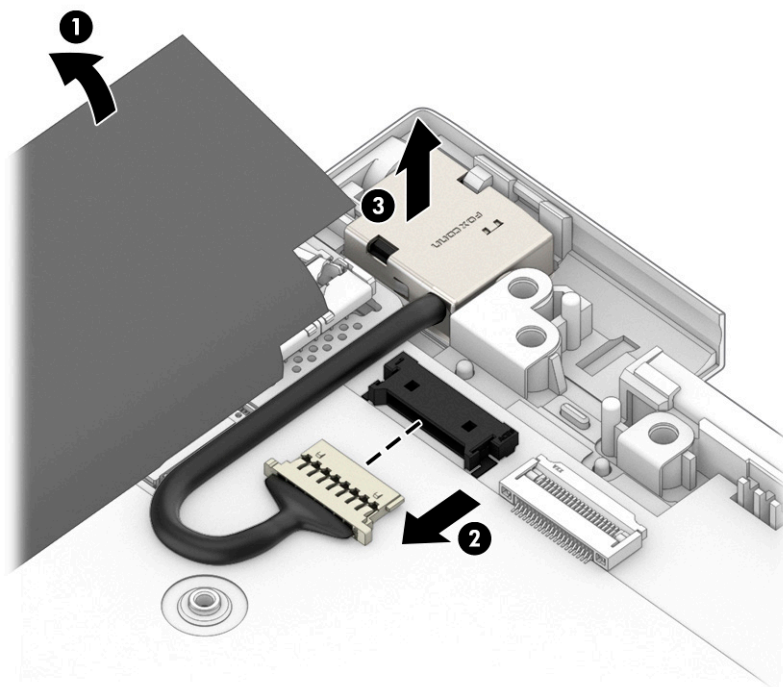

Reverse this procedure to install the power connector cable.

## Keyboard/top cover

The top cover with keyboard remains after removing all other spare parts from the computer.

In this section, the first table provides the main spare part number for the top cover/keyboards. The table provides the country codes.

**Table 5-12 Keyboard/top cover description and part number**

Description	Spare part number
<b>Keyboard/top cover</b>	
Keyboard/top cover with natural silver finish with backlight	L96800-xx1
Keyboard/top cover with pale gold finish with backlight	L96803-xx1
Keyboard/top cover with touchpad and nightfall black finish with wood veneer with backlight	L96805-xx1

**NOTE:** Touchpad cannot be replaced.

**Table 5-13 Keyboard country codes**

For use in country or region	Spare part number	For use in country or region	Spare part number	For use in country or region	Spare part number
Belgium	-A41	Israel	-BB1	Slovenia	-BA1
Czech Republic and Slovakia	-FL1	Italy	-061	Spain	-071
Denmark, Finland, and Norway	-DH1	The Netherlands	-B31	Switzerland	-BG1
France	-051	Portugal	-131	Turkey	-141
French Canada	-DB1	Romania	-271	Ukraine	-BD1
Germany	-041	Russia	-251	United Kingdom	-031
Greece	-151	Saudi Arabia	-171	United States	-001
Hungary	-211				

---

## 6 Backing up, restoring, and recovering

This chapter provides information about the following processes, which are standard procedure for most products:

- **Backing up your personal information**—You can use Windows tools to back up your personal information (see [Using Windows tools on page 64](#)).
- **Creating a restore point**—You can use Windows tools to create a restore point (see [Using Windows tools on page 64](#)).
- **Creating recovery media** (select products only)—You can use the HP Cloud Recovery Download Tool (select products only) to create recovery media (see [Using the HP Cloud Recovery Download Tool to create recovery media \(select products only\) on page 64](#)).
- **Restoring and recovery**—Windows offers several options for restoring from backup, refreshing the computer, and resetting the computer to its original state (see [Using Windows tools on page 64](#)).

---

 **IMPORTANT:** If you will be performing recovery procedures on a tablet, the tablet battery must be at least 70% charged before you start the recovery process.

**IMPORTANT:** For a tablet with a detachable keyboard, connect the tablet to the keyboard base before beginning any recovery process.

---

### Backing up information and creating recovery media

#### Using Windows tools

---

 **IMPORTANT:** Windows is the only option that allows you to back up your personal information. Schedule regular backups to avoid information loss.

---

You can use Windows tools to back up personal information and create system restore points and recovery media.

---

 **NOTE:** If computer storage is 32 GB or less, Microsoft System Restore is disabled by default.

---

For more information and steps, see the Get Help app.

1. Select the **Start** button, and then select the **Get Help** app.
2. Enter the task you want to perform.

---

 **NOTE:** You must be connected to the Internet to access the Get Help app.

---

#### Using the HP Cloud Recovery Download Tool to create recovery media (select products only)

You can use the HP Cloud Recovery Download Tool to create HP Recovery media on a bootable USB flash drive.

For details:

- ▲ Go to <http://www.hp.com/support>, search for HP Cloud Recovery, and then select the result that matches the type of computer that you have.





---

**NOTE:** If you cannot create recovery media yourself, contact support to obtain recovery discs. Go to <http://www.hp.com/support>, select your country or region, and then follow the on-screen instructions.

---

## Restoring and recovery

### Restoring, resetting, and refreshing using Windows tools

Windows offers several options for restoring, resetting, and refreshing the computer. For details, see [Using Windows tools on page 64](#).

### Recovering using HP Recovery media

You can use HP Recovery media to recover the original operating system and software programs that were installed at the factory. On select products, it can be created on a bootable USB flash drive using the HP Cloud Recovery Download Tool. For details, see [Using the HP Cloud Recovery Download Tool to create recovery media \(select products only\) on page 64](#).



---

**NOTE:** If you cannot create recovery media yourself, contact support to obtain recovery discs. Go to <http://www.hp.com/support>, select your country or region, and then follow the on-screen instructions.

---

To recover your system:

- ▲ Insert the HP Recovery media, and then restart the computer.

### Changing the computer boot order

If your computer does not restart using the HP Recovery media, you can change the computer boot order. This is the order of devices listed in BIOS where the computer looks for startup information. You can change the selection to an optical drive or a USB flash drive, depending on the location of your HP Recovery media.

To change the boot order:



---

**IMPORTANT:** For a tablet with a detachable keyboard, connect the tablet to the keyboard base before beginning these steps.

---

1. Insert the HP Recovery media.
2. Access the system **Startup** menu.

For computers or tablets with keyboards attached:

- ▲ Turn on or restart the computer or tablet, quickly press **esc**, and then press **f9** for boot options.

For tablets without keyboards:

- ▲ Turn on or restart the tablet, quickly hold down the volume up button, and then select **f9**.

– or –

Turn on or restart the tablet, quickly hold down the volume down button, and then select **f9**.

3. Select the optical drive or USB flash drive from which you want to boot, and then follow the on-screen instructions.

## Using HP Sure Recover (select products only)

Select computer models are configured with HP Sure Recover, a PC OS recovery solution built into the hardware and firmware. HP Sure Recover can fully restore the HP OS image without installed recovery software.

Using HP Sure Recover, an administrator or user can restore the system and install:

- Latest version of the operating system
- Platform-specific device drivers
- Software applications, in the case of a custom image

To access the latest documentation for HP Sure Recover, go to <http://www.hp.com/support>. Select **Find your product**, and then follow the on-screen instructions.

# 7 Using HP PC Hardware Diagnostics

## Using HP PC Hardware Diagnostics Windows (select products only)

HP PC Hardware Diagnostics Windows is a Windows-based utility that allows you to run diagnostic tests to determine whether the computer hardware is functioning properly. The tool runs within the Windows operating system to diagnose hardware failures.

If HP PC Hardware Diagnostics Windows is not installed on your computer, first you must download and install it. To download HP PC Hardware Diagnostics Windows, see [Downloading HP PC Hardware Diagnostics Windows on page 67](#).

After HP PC Hardware Diagnostics Windows is installed, follow these steps to access it from HP Help and Support or HP Support Assistant.

1. To access HP PC Hardware Diagnostics Windows from HP Help and Support:

- a. Select the **Start** button, and then select **HP Help and Support**.
- b. Select **HP PC Hardware Diagnostics Windows**.

– or –

To access HP PC Hardware Diagnostics Windows from HP Support Assistant:

- a. Type `support` in the taskbar search box, and then select the **HP Support Assistant** app.

– or –

Select the question mark icon in the taskbar.

- b. Select **Troubleshooting and fixes**.
- c. Select **Diagnostics**, and then select **HP PC Hardware Diagnostics Windows**.

2. When the tool opens, select the type of diagnostic test that you want to run, and then follow the on-screen instructions.



**NOTE:** To stop a diagnostic test, select **Cancel**.

When HP PC Hardware Diagnostics Windows detects a failure that requires hardware replacement, a 24-digit Failure ID code is generated. The screen displays one of the following options:

- A Failure ID link is displayed. Select the link and follow the on-screen instructions.
- Instructions for calling support are displayed. Follow those instructions.

## Downloading HP PC Hardware Diagnostics Windows

- The HP PC Hardware Diagnostics Windows downloading instructions are provided in English only.
- You must use a Windows computer to download this tool because only .exe files are provided.

## Downloading the latest HP PC Hardware Diagnostics Windows version

To download HP PC Hardware Diagnostics Windows, follow these steps:

1. Go to <http://www.hp.com/go/techcenter/pcdiags>. The HP PC Diagnostics home page is displayed.
2. Select **Download HP Diagnostics Windows**, and then select a location on your computer or a USB flash drive.

The tool downloads to the selected location.

– or –

You can use the following steps to download the HP PC Hardware Diagnostics Windows from the Microsoft Store:

1. Select the Microsoft app on your desktop or enter `Microsoft Store` in the taskbar search box.
2. Enter `HP PC Hardware Diagnostics Windows` in the **Microsoft Store** search box.
3. Follow the on-screen directions.

The tool downloads to the selected location.

## Downloading HP Hardware Diagnostics Windows by product name or number (select products only)

---

 **NOTE:** For some products, you might have to download the software to a USB flash drive by using the product name or number.

---

To download HP PC Hardware Diagnostics Windows by product name or number, follow these steps:

1. Go to <http://www.hp.com/support>.
2. Select **Get software and drivers**, select your type of product, and then enter the product name or number in the search box that is displayed.
3. In the **Diagnostics** section, select **Download**, and then follow the on-screen instructions to select the specific Windows diagnostics version to be downloaded to your computer or USB flash drive.

The tool downloads to the selected location.

## Installing HP PC Hardware Diagnostics Windows

To install HP PC Hardware Diagnostics Windows, follow these steps:

- ▲ Navigate to the folder on your computer or the USB flash drive where the .exe file downloaded, double-click the .exe file, and then follow the on-screen instructions.

## Using HP PC Hardware Diagnostics UEFI

---

 **NOTE:** For Windows 10 S computers, you must use a Windows computer and a USB flash drive to download and create the HP UEFI support environment because only .exe files are provided. For more information, see [Downloading HP PC Hardware Diagnostics UEFI to a USB flash drive on page 69](#).

---

HP PC Hardware Diagnostics UEFI (Unified Extensible Firmware Interface) allows you to run diagnostic tests to determine whether the computer hardware is functioning properly. The tool runs outside the operating system so that it can isolate hardware failures from issues that are caused by the operating system or other software components.

If your PC does not start in Windows, you can use HP PC Hardware Diagnostics UEFI to diagnose hardware issues.

When HP PC Hardware Diagnostics UEFI detects a failure that requires hardware replacement, a 24-digit Failure ID code is generated. For assistance in solving the problem:

- ▲ Select **Contact HP**, accept the HP privacy disclaimer, and then use a mobile device to scan the Failure ID code that appears on the next screen. The HP Customer Support - Service Center page appears with your Failure ID and product number automatically filled in. Follow the on-screen instructions.
- or –
- Contact support, and provide the Failure ID code.

---

 **NOTE:** To start diagnostics on a convertible computer, your computer must be in notebook mode, and you must use the attached keyboard.

 **NOTE:** If you need to stop a diagnostic test, press *esc*.

---

## Starting HP PC Hardware Diagnostics UEFI

To start HP PC Hardware Diagnostics UEFI, follow these steps:

1. Turn on or restart the computer, and quickly press *esc*.
2. Press *f2*.

The BIOS searches three places for the diagnostic tools, in the following order:

- a. Connected USB flash drive

 **NOTE:** To download the HP PC Hardware Diagnostics UEFI tool to a USB flash drive, see [Downloading the latest HP PC Hardware Diagnostics UEFI version on page 69](#).

- b. Hard drive

- c. BIOS

3. When the diagnostic tool opens, select a language, select the type of diagnostic test you want to run, and then follow the on-screen instructions.

## Downloading HP PC Hardware Diagnostics UEFI to a USB flash drive

Downloading HP PC Hardware Diagnostics UEFI to a USB flash drive can be useful in the following situations:

- HP PC Hardware Diagnostics UEFI is not included in the preinstallation image.
- HP PC Hardware Diagnostics UEFI is not included in the HP Tool partition.
- The hard drive is damaged.

---

 **NOTE:** The HP PC Hardware Diagnostics UEFI downloading instructions are provided in English only, and you must use a Windows computer to download and create the HP UEFI support environment because only .exe files are provided.

---

## Downloading the latest HP PC Hardware Diagnostics UEFI version

To download the latest HP PC Hardware Diagnostics UEFI version to a USB flash drive:

1. Go to <http://www.hp.com/go/techcenter/pcdiags>. The HP PC Diagnostics home page is displayed.
2. Select **Download HP Diagnostics UEFI**, and then select **Run**.

## Downloading HP PC Hardware Diagnostics UEFI by product name or number (select products only)

 **NOTE:** For some products, you might have to download the software to a USB flash drive by using the product name or number.

To download HP PC Hardware Diagnostics UEFI by product name or number (select products only) to a USB flash drive:

1. Go to <http://www.hp.com/support>.
2. Enter the product name or number, select your computer, and then select your operating system.
3. In the **Diagnostics** section, follow the on-screen instructions to select and download the specific UEFI Diagnostics version for your computer.

## Using Remote HP PC Hardware Diagnostics UEFI settings (select products only)

Remote HP PC Hardware Diagnostics UEFI is a firmware (BIOS) feature that downloads HP PC Hardware Diagnostics UEFI to your computer. It can then execute the diagnostics on your computer, and it might upload results to a preconfigured server. For more information about Remote HP PC Hardware Diagnostics UEFI, go to <http://www.hp.com/go/techcenter/pcdiags>, and then select **Find out more**.

## Downloading Remote HP PC Hardware Diagnostics UEFI

 **NOTE:** HP Remote PC Hardware Diagnostics UEFI is also available as a SoftPaq that you can download to a server.

## Downloading the latest Remote HP PC Hardware Diagnostics UEFI version

To download the latest Remote HP PC Hardware Diagnostics UEFI version, follow these steps:

1. Go to <http://www.hp.com/go/techcenter/pcdiags>. The HP PC Diagnostics home page is displayed.
2. Select **Download Remote Diagnostics**, and then select **Run**.

## Downloading Remote HP PC Hardware Diagnostics UEFI by product name or number

 **NOTE:** For some products, you might have to download the software by using the product name or number.

To download HP Remote PC Hardware Diagnostics UEFI by product name or number, follow these steps:

1. Go to <http://www.hp.com/support>.
2. Select **Get software and drivers**, select your type of product, enter the product name or number in the search box that is displayed, select your computer, and then select your operating system.
3. In the **Diagnostics** section, follow the on-screen instructions to select and download the **Remote UEFI** version for the product.

## Customizing Remote HP PC Hardware Diagnostics UEFI settings

Using the Remote HP PC Hardware Diagnostics setting in Computer Setup (BIOS), you can perform the following customizations:

- Set a schedule for running diagnostics unattended. You can also start diagnostics immediately in interactive mode by selecting **Execute Remote HP PC Hardware Diagnostics**.
- Set the location for downloading the diagnostic tools. This feature provides access to the tools from the HP website or from a server that has been preconfigured for use. Your computer does not require the traditional local storage (such as a hard drive or USB flash drive) to run remote diagnostics.
- Set a location for storing the test results. You can also set the user name and password that you use for uploads.
- Display status information about the diagnostics run previously.

To customize Remote HP PC Hardware Diagnostics UEFI settings, follow these steps:

1. Turn on or restart the computer, and when the HP logo appears, press **f10** to enter Computer Setup.
2. Select **Advanced**, and then select **Settings**.
3. Make your customization selections.
4. Select **Main**, and then **Save Changes and Exit** to save your settings.

Your changes take effect when the computer restarts.

# 8 Specifications

## Computer specifications

**Table 8-1 Computer specifications**

	<b>Metric</b>	<b>U.S.</b>
<b>Dimensions</b>		
Width	<b>30.65 cm</b>	12.07 in
Depth	<b>19.50 cm</b>	7.70 in
Height (front to back)	<b>1.70 cm</b>	0.67 in
<b>Weight</b>	<b>1.30 kg</b> (depending on configuration)	2.87 lb
<b>Input power</b>		
Operating voltage and current	19.5 V dc @ 3.33 A – 65 W	
	19 V dc @ 4.62 A – 90 W	
	19.5 V dc @ 2.31 – 45 W (select models only)	
<b>Temperature</b>		
Operating	<b>5°C to 35°C</b>	41°F to 95°F
Nonoperating	<b>-20°C to 60°C</b>	-4°F to 140°F
<b>Relative humidity</b> (noncondensing)		
Operating	10% to 90%	
Nonoperating	5% to 95%	
<b>Maximum altitude</b> (unpressurized)		
Operating	<b>-15 m to 3,048 m</b>	-05 ft to 10,000 ft
Nonoperating	<b>-15 m to 12,192 m</b>	-50 ft to 40,000 ft
<b>NOTE:</b> Applicable product safety standards specify thermal limits for plastic surfaces. The device operates well within this range of temperatures.		



## xx cm (xx-in) display specifications

**Table 8-2 Display specifications**

	<b>Metric</b>	<b>U.S.</b>
<b>Dimensions</b>		
Height	<b>20.77 cm</b>	8.175 in
Width	<b>37.78 cm</b>	14.875 in
Diagonal	<b>39.62 cm</b>	15.600 in
<b>Number of colors</b>	Up to 16.8 million	
<b>Contrast ratio</b>	500:1 (typical)	
<b>Brightness</b>	200 nits	
<b>Pixel resolution</b>		
Pitch	0.252mm × 0.252mm	
Format	1366 × 768	
Configuration	RGB vertical stripe	
<b>Backlight</b>	LED	
<b>Character display</b>	80 × 25	
<b>Total power consumption</b>	2.0 W	
<b>Viewing angle</b>	±65° horizontal, ±50° vertical (typical)	

## Hard drive specifications

**Table 8-3 Hard drive specifications**

	<b>500 GB*</b>	<b>750 GB*</b>
<b>Dimensions</b>		
Height	9.5 mm	9.5 mm
Width	70 mm	70 mm
Weight	107 g max	102 g max
<b>Interface type</b>	SATA	SATA
<b>Transfer rate</b>	300 MB/s	300 MB/s
<b>Security</b>	ATA security	ATA security
<b>Seek times</b> (typical read, including setting)		
Single track	1.5 ms	1.1 ms
Average	12.0 ms	12.0 ms
Maximum	22.0 ms	21.0 ms
<b>Logical blocks</b>	976,752,240	1,465,149,168

**Table 8-3 Hard drive specifications (continued)**

	<b>500 GB*</b>	<b>750 GB*</b>
<b>Disk rotational speed</b>	5400 rpm	5400 rpm
<b>Operating temperature</b>	<b>0°C to 60°C</b> (0°F to 140°F)	<b>0°C to 60°C</b> (0°F to 140°F)

\*Size refers to hard drive storage capacity. Actual accessible capacity is less. Actual drive specifications may differ slightly.

**NOTE:** Certain restrictions and exclusions apply. Contact support for details.

---

## 9 Power cord set requirements

The wide-range input feature of the computer permits it to operate from any line voltage from 100 to 120 V ac, or from 220 to 240 V ac.

The 3-conductor power cord set included with the computer meets the requirements for use in the country or region where the equipment is purchased.

Power cord sets for use in other countries or regions must meet the requirements of the country and region where the computer is used.

### Requirements for all countries

The following requirements are applicable to all countries and regions:

- The length of the power cord set must be at least **1.0 m** (3.3 ft) and no more than **2.0 m** (6.5 ft).
- All power cord sets must be approved by an acceptable accredited agency responsible for evaluation in the country or region where the power cord set will be used.
- The power cord sets must have a minimum current capacity of 10 A and a nominal voltage rating of 125 or 250 V ac, as required by the power system of each country or region.
- The appliance coupler must meet the mechanical configuration of an EN 60 320/IEC 320 Standard Sheet C13 connector for mating with the appliance inlet on the back of the computer.

## Requirements for specific countries and regions

**Table 9-1 Power cord requirements for specific countries and regions**

Country/region	Accredited agency	Applicable note number
Argentina	IRAM	1
Australia	SAA	1
Austria	OVE	1
Belgium	CEBEC	1
Brazil	ABNT	1
Canada	CSA	2
Chile	IMQ	1
Denmark	DEMKO	1
Finland	FIMKO	1
France	UTE	1
Germany	VDE	1
India	BIS	1
Israel	SII	1
Italy	IMQ	1
Japan	JIS	3
The Netherlands	KEMA	1
New Zealand	SANZ	1
Norway	NEMKO	1
The People's Republic of China	CCC	4
Saudi Arabia	SASO	7
Singapore	PSB	1
South Africa	SABS	1
South Korea	KTL	5
Sweden	SEMKO	1
Switzerland	SEV	1
Taiwan	BSMI	6
Thailand	TISI	1
The United Kingdom	ASTA	1
The United States	UL	2

1. The flexible cord must be Type H05VV-F, 3-conductor, 0.75 mm<sup>2</sup> conductor size. Power cord set fittings (appliance coupler and wall plug) must bear the certification mark of the agency responsible for evaluation in the country or region where it will be used.

**Table 9-1 Power cord requirements for specific countries and regions (continued)**

Country/region	Accredited agency	Applicable note number
		2. The flexible cord must be Type SVT/SJT or equivalent, No. 18 AWG, 3-conductor. The wall plug must be a two-pole grounding type with a NEMA 5-15P (15 A, 125 V ac) or NEMA 6-15P (15 A, 250 V ac) configuration. CSA or C-UL mark. UL file number must be on each element.
		3. The appliance coupler, flexible cord, and wall plug must bear a T mark and registration number in accordance with the Japanese Dentori Law. The flexible cord must be Type VCTF, 3-conductor, 0.75 mm <sup>2</sup> or 1.25 mm <sup>2</sup> conductor size. The wall plug must be a two-pole grounding type with a Japanese Industrial Standard C8303 (7 A, 125 V ac) configuration.
		4. The flexible cord must be Type RVV, 3-conductor, 0.75 mm <sup>2</sup> conductor size. Power cord set fittings (appliance coupler and wall plug) must bear the CCC certification mark.
		5. The flexible cord must be Type H05VV-F 3-conductor, 0.75 mm <sup>2</sup> conductor size. KTL logo and individual approval number must be on each element. Approval number and logo must be printed on a flag label.
		6. The flexible cord must be Type HVCTF 3-conductor, 1.25 mm <sup>2</sup> conductor size. Power cord set fittings (appliance coupler, cable, and wall plug) must bear the BSMI certification mark.
		7. For 127 V ac, the flexible cord must be Type SVT or SJT 3-conductor, 18 AWG, with plug NEMA 5-15P (15 A, 125 V ac), with UL and CSA or C-UL marks. For 240 V ac, the flexible cord must be Type H05VV-F 3-conductor, 0.75 mm <sup>2</sup> or 1.00 mm <sup>2</sup> conductor size, with plug BS 1363/A with BSI or ASTA marks.

---

## 10 Recycling

When a non-rechargeable or rechargeable battery has reached the end of its useful life, do not dispose of the battery in general household waste. Follow the local laws and regulations in your area for battery disposal.

HP encourages customers to recycle used electronic hardware, HP original print cartridges, and rechargeable batteries. For more information about recycling programs, see the HP Web site at <http://www.hp.com/recycle>.

# Index

## A

- AC adapter and battery light, identifying 5
- ac adapter, spare part numbers 30
- action keys
  - identifying 13
- audio, product description 2
- audio-out (headphone)/audio-in (microphone) combo jack, identifying 6

## B

- back cover, with antenna
  - spare part number 28
- backup, creating 64
- backups 64
- battery
  - removal 39
  - spare part number 39
  - spare part numbers 26
- Bluetooth label 16
- boot order, changing 65
- bottom components 14
- bottom cover
  - removal 38
  - spare part number 38
- buttons
  - left touchpad 9
  - power 11, 13
  - right touchpad 9

## C

- camera
  - identifying 7
  - spare part number 28
- camera cable, spare part number 29
- camera light, identifying 7
- camera privacy key, identifying 13
- camera privacy light, identifying 10
- caps lock light, identifying 10
- cautions
  - electrostatic discharge 33
- components
  - bottom 14

- display 7
- keyboard area 9
- left side 6
- right side 5
- computer major components 17
- computer specifications 72
- connectors
  - power 5

## D

- display
  - specifications 73
- display assembly
  - removal 54
  - subcomponents 27
- display components 7
- display panel
  - product description 1
  - spare part number 27
- display panel cable
  - spare part number 28

## E

- electrostatic discharge (ESD) 33
  - preventing damage 34
- esc key, identifying 13

## F

- fan
  - removal 47
  - spare part number 47
- fans
  - spare part numbers 26
- fingerprint reader, identifying 11, 13
- fn key, identifying 13

## G

- graphics, product description 1
- grounding methods 35
- guidelines
  - packaging 36
  - transporting 36
  - workstation 33

## H

- hard drive
  - product description 1
  - specifications 73
- hardware, locating 4
- heat sink
  - removal 48
  - spare part number 48
  - spare part numbers 26
- hinge kit
  - spare part number 28
- HP PC Hardware Diagnostics UEFI
  - downloading 69
  - starting 69
  - using 68
- HP PC Hardware Diagnostics Windows
  - downloading 67
  - installing 68
  - using 67
- HP Recovery media
  - recovery 65
- HP Sure Recover 66

## I

- internal microphones, identifying 7
- IR sensor
  - spare part number 26

## J

- jacks
  - audio-out (headphone)/audio-in (microphone) 6

## K

- keyboard
  - product description 2
  - keyboard/top cover
    - removal 63
    - spare part numbers 63
- keys
  - action 13
  - camera privacy 13
  - esc 13
  - fn 13
  - Windows 13

- L**
- labels
  - Bluetooth 16
  - regulatory 16
  - serial number 15
  - service 15
  - wireless certification 16
  - WLAN 16
- left side components 6
- lights
  - AC adapter and battery 5
  - camera 7
  - camera privacy 10
  - caps lock 10
  - microphone mute 10
  - mute 10
  - power 10
- M**
- memory module
  - product description 1
- microphone
  - product description 2
- microphone mute light, identifying 10
- model name 1
- mute light, identifying 10
- O**
- operating system, product description 3
- Optane Memory Module
  - removal 43
  - spare part numbers 43
- P**
- packaging guidelines 36
- pointing device, product description 2
- ports
  - product description 2
  - USB 6
  - USB port with HP Sleep and Charge 5
  - USB Type-C Thunderbolt port with HP Sleep and Charge 6
  - USB Type-C with HP Sleep and Charge 6
- power button, identifying 11, 13
- power cable
  - spare part numbers 26
- power connector
  - identifying 5
- power connector cable
  - removal 62
  - spare part number 62
- power cord
  - requirements for all countries 75
  - requirements for specific countries and regions 76
  - set requirements 75
  - spare part numbers 30
- power lights, identifying 10
- power requirements, product description 2
- processor
  - product description 1
- product description
  - audio 2
  - display panel 1
  - graphics 1
  - hard drive 1
  - keyboard 2
  - memory module 1
  - microphone 2
  - operating system 3
  - pointing device 2
  - ports 2
  - power requirements 2
  - processors 1
  - product name 1
  - security 3
  - serviceability 3
  - video 2
  - wireless 2
- product name 1
- product name and number, computer 15
- R**
- recovery 64
  - discs 65
  - HP Recovery partition 65
  - media 65
  - USB flash drive 65
- recovery media
  - creating using HP Cloud Recovery Download Tool 64
  - creating using Windows tools 64
- regulatory information
  - regulatory label 16
  - wireless certification labels 16
- Remote HP PC Hardware Diagnostics
  - UEFI settings
    - customizing 70
    - using 70
- removal/replacement procedures 37
- restoring 64
- right side components 5
- rubber feet
  - removal 38
  - spare part number 38
- S**
- security, product description 3
- serial number, computer 15
- service labels, locating 15
- serviceability, product description 3
- slots
  - microSD memory card reader 5
- software
  - locating 4
- software installed
  - locating 4
- solid-state drive 29
  - removal 43
  - spare part number 26, 29
  - spare part numbers 43
- speaker kit
  - spare part number 26
- speakers
  - identifying 14
  - removal 42
  - spare part number 42
- special keys, using 13
- specifications
  - computer 72
  - display 73
  - hard drive 73
- static electricity 34
- system board
  - removal 50
  - spare part number 26
  - spare part numbers 50
- system restore point, creating 64



## T

- Thunderbolt port with HP Sleep and Charge, identifying USB Type-C 6
- topcover
  - spare part numbers 19
- Touchpad 29
  - removal 40
  - spare part numbers 26, 40
- touchpad
  - settings 9
- touchpad buttons
  - identifying 9
- touchpad cable, spare part number 40
- touchpad zone, identifying 9
- transporting guidelines 36
- traveling with the computer 16

## X

- xxxxxx 30
- xxxxxx, spare part number 30

## U

- USB port with HP Sleep and Charge, identifying 5
- USB port, identifying 6
- USB Type-C port with HP Sleep and Charge, identifying 6
- USB Type-C Thunderbolt port with HP Sleep and Charge, identifying 6

## V

- vents, identifying 14
- video 2
- video, product description 2

## W

- Windows
  - backup 64
  - recovery media 64
  - system restore point 64
- Windows key, identifying 13
- Windows tools, using 64
- wireless certification label 16
- wireless, product description 2
- WLAN antennas, identifying 7
- WLAN device 16
- WLAN label 16
- WLAN module
  - removal 45
- WLAN modules
  - spare part numbers 26
- workstation guidelines 33
- WWAN module
  - spare part numbers 45