



# LASERJET ENTERPRISE 500 MFP

## User Guide



M525





# HP LaserJet Enterprise 500 MFP M525

User Guide

## Copyright and License

© 2012 Copyright Hewlett-Packard Development Company, L.P.

Reproduction, adaptation, or translation without prior written permission is prohibited, except as allowed under the copyright laws.

The information contained herein is subject to change without notice.

The only warranties for HP products and services are set forth in the express warranty statements accompanying such products and services. Nothing herein should be construed as constituting an additional warranty. HP shall not be liable for technical or editorial errors or omissions contained herein.

Part number: CF116-90912

Edition 1, 5/2012

## Trademark Credits

Adobe®, Adobe Photoshop®, Acrobat®, and PostScript® are trademarks of Adobe Systems Incorporated.

Apple and the Apple logo are trademarks of Apple Computer, Inc., registered in the U.S. and other countries. iPod is a trademark of Apple Computer, Inc. iPod is for legal or rightholder-authorized copying only. Don't steal music.

Microsoft®, Windows®, Windows® XP, and Windows Vista® are U.S. registered trademarks of Microsoft Corporation.

UNIX® is a registered trademark of The Open Group.



---

# Table of contents

<b>1 Product introduction</b>	<b>1</b>
Product views	2
Product front view	2
Product back view	3
Interface ports	4
Serial number and model number location	5
Control panel	6
Control-panel Home screen	6
Control-panel cleaning	7
Control-panel help	7
Product reports	9
<b>2 Connect the product and install software</b>	<b>11</b>
Connect the product to a computer by using a USB cable and install the software (Windows)	12
Connect the product to a network by using a network cable and install the software (Windows)	13
Configure the IP address	13
Install the software	14
Connect the product to a computer by using a USB cable and install the software (Mac)	15
Connect the product to a network by using a network cable and install the software (Mac)	16
Configure the IP address	16
Install the software	17
<b>3 Input trays and output bins</b>	<b>19</b>
Supported paper sizes	20
Supported paper types	23
Configure trays	24
Configure a tray when loading paper	24
Configure a tray to match print job settings	24
Configure a tray by using the control panel	24
Alternative letterhead mode	25
Tray 1	26

Tray capacity and paper orientation .....	26
Load Tray 1 .....	27
Tray 2 and the optional 500-sheet trays .....	29
Tray capacity and paper orientation .....	29
Load Tray 2 or the optional 500-sheet trays .....	30
Use paper output options .....	32
Print to the standard output bin .....	32
Print to the rear output bin .....	32
Use the convenience stapler (stapling models only) .....	33

#### **4 Parts, supplies, and accessories ..... 35**

Order parts, accessories, and supplies .....	36
HP policy on non-HP supplies .....	37
HP anticounterfeit Web site .....	38
Print when a toner cartridge is at estimated end of life .....	39
Enable or disable the Very Low Settings options from the control panel .....	40
Customer self-repair parts .....	41
Accessories .....	43
Toner cartridge .....	44
Toner cartridge view .....	45
Toner cartridge information .....	46
Recycle toner cartridge .....	46
Toner-cartridge storage .....	46
HP policy on non-HP toner cartridges .....	46
Replace the toner cartridge .....	47
Staples (stapling models only) .....	50
Load staples .....	50

#### **5 Print ..... 53**

Supported print drivers (Windows) .....	54
HP Universal Print Driver (UPD) .....	54
UPD installation modes .....	55
Change print-job settings (Windows) .....	56
Change the settings for all print jobs until the software program is closed .....	56
Change the default settings for all print jobs .....	56
Change the product configuration settings .....	56
Change print-job settings (Mac OS X) .....	57
Change the settings for all print jobs until the software program is closed .....	57
Change the default settings for all print jobs .....	57
Change the product configuration settings .....	57
Print tasks (Windows) .....	58

Use a printing shortcut (Windows) .....	58
Create printing shortcuts (Windows) .....	60
Automatically print on both sides (Windows) .....	63
Print multiple pages per sheet (Windows) .....	65
Select the page orientation (Windows) .....	67
Select the paper type (Windows) .....	69
Print the first or last page on different paper (Windows) .....	72
Scale a document to fit page size (Windows) .....	75
Create a booklet (Windows) .....	77
Print tasks (Mac OS X) .....	79
Use a printing preset (Mac OS X) .....	79
Create a printing preset (Mac OS X) .....	79
Automatically print on both sides (Mac OS X) .....	79
Print multiple pages per sheet (Mac OS X) .....	79
Select the page orientation (Mac OS X) .....	80
Select the paper type (Mac OS X) .....	80
Print a cover page (Mac OS X) .....	80
Scale a document to fit page size (Mac OS X) .....	81
Create a booklet (Mac OS X) .....	81
Additional print tasks (Windows) .....	82
Cancel a print job (Windows) .....	82
Select the paper size (Windows) .....	82
Select a custom paper size (Windows) .....	83
Print watermarks (Windows) .....	83
Additional print tasks (Mac OS X) .....	84
Cancel a print job (Mac OS X) .....	84
Select the paper size (Mac OS X) .....	84
Select a custom paper size (Mac OS X) .....	84
Print watermarks (Mac OS X) .....	85
Store print jobs on the product .....	86
Create a stored job (Windows) .....	86
Create a stored job (Mac OS X) .....	88
Print a stored job .....	89
Delete a stored job .....	89
Add a job-separator page (Windows) .....	90
Use HP ePrint .....	91
Use the HP ePrint Mobile Driver .....	92
Use Apple AirPrint .....	93
Use HP Smart Print (Windows) .....	94
Use easy-access USB printing .....	95
Print easy-access USB documents .....	95

<b>6 Copy</b> .....	<b>97</b>
Set new default copy settings .....	98
Restore default copy settings .....	100
Make a single copy .....	101
Make multiple copies .....	102
Copy a multiple-page original .....	104
Collate a copy job .....	106
Copy on both sides (duplex) .....	108
Copy on both sides automatically .....	108
Copy on both sides manually .....	109
Reduce or enlarge a copy image .....	111
Optimize copy quality for text or pictures .....	113
Adjust the copy lightness/darkness .....	114
Set the paper size and type for copying on special paper .....	116
Use Job Build mode .....	117
Copy a book .....	118
Copy a photo .....	120
<b>7 Scan/send</b> .....	<b>123</b>
Set up scan/send features .....	124
Change default scan/send settings from the product control panel .....	126
Send a scanned document to a network folder .....	128
Send a scanned document to a folder in the product memory .....	131
Send a scanned document to a USB flash drive .....	132
Send a scanned document to one or more email addresses .....	135
Use the address book to send email .....	138
Add contacts to the address book from the product control panel .....	138
Send a document to email by using the address book .....	140
Scan a photo .....	143
<b>8 Fax</b> .....	<b>145</b>
Configure required fax settings .....	146
Fax Setup Wizard .....	146
Set or verify the date and time .....	147
Set or verify the date/time format .....	147
Configure fax dialing settings .....	149
Configure general fax send settings .....	151
Configure fax billing codes .....	152
Configure default options for fax send jobs .....	153
Configure fax receive settings .....	154

Use a fax printing schedule .....	155
Block incoming faxes .....	156
Create a blocked-fax list .....	156
Delete numbers from the blocked-fax list .....	156
Configure default options for fax receive jobs .....	157
Fax archiving and forwarding .....	158
Enable fax archiving .....	158
Enable fax forwarding .....	158
Create a speed dial list .....	160
Add a number to an existing speed dial list .....	163
Delete a speed dial list .....	164
Delete a single number from a speed dial list .....	165
Send a fax by entering numbers manually .....	166
Send a fax by using a speed dial .....	168
Search a speed-dial list by name .....	170
Send a fax by using fax address book numbers .....	171
Search the fax address book .....	173
Cancel a fax .....	174
Fax reports .....	175
Fax activity log .....	175
Billing code report .....	176
Blocked fax list report .....	176
Speed dial list report .....	176
Fax call report .....	176

## **9 Manage the product ..... 177**

Configure IP network settings .....	178
Printer sharing disclaimer .....	178
View or change network settings .....	178
Manually configure IPv4 TCP/IP parameters from the control panel .....	178
Manually configure IPv6 TCP/IP parameters from the control panel .....	179
HP Embedded Web Server .....	180
Open the HP Embedded Web Server .....	180
HP Embedded Web Server features .....	181
Information tab .....	181
General tab .....	181
Copy/Print tab .....	182
Scan/Digital Send tab .....	183
Fax tab (Fax models only) .....	184
Troubleshooting tab .....	184
Security tab .....	185

HP Web Services tab .....	185
Networking tab .....	185
Other Links list .....	185
HP Utility (Mac OS X) .....	187
Open HP Utility .....	187
HP Utility features .....	187
Use HP Web Jetadmin software .....	189
Economy settings .....	190
Print with EconoMode .....	190
Optimize speed or energy use .....	190
Set sleep mode .....	191
Set the sleep schedule .....	191
Product security features .....	193
Security statements .....	193
IP Security .....	193
Sign in to the product .....	193
Assign a system password .....	193
Encryption support: HP High-Performance Secure Hard Disks .....	194
Lock the formatter cage .....	194
Upgrade the product firmware .....	195

## **10 Solve problems ..... 197**

Solve problems checklist .....	198
Factors that affect product performance .....	200
Restore factory-set defaults .....	201
Control-panel help .....	202
Paper feeds incorrectly or becomes jammed .....	203
The product does not pick up paper .....	203
The product picks up multiple sheets of paper .....	203
The document feeder jams, skews, or picks up multiple sheets of paper .....	204
Prevent paper jams .....	204
Clear jams .....	205
Auto-navigation for clearing jams .....	205
Jam locations .....	205
Clear jams in the document feeder .....	206
Clear jams in the output-bin area .....	207
Clear jams in Tray 1 .....	208
Clear jams in Tray 2 or an optional 500-sheet tray .....	210
Clear jams in the toner-cartridge area .....	214
Clear jams in the rear-door and the fuser area .....	216
Clear jams in the duplexer .....	219

Change jam recovery .....	225
Improve print quality .....	226
Print from a different software program .....	226
Set the paper-type setting for the print job .....	226
Check the paper type setting (Windows) .....	226
Check the paper type setting (Mac OS X) .....	226
Check the toner-cartridge status .....	227
Print a cleaning page .....	227
Visually inspect the toner cartridge .....	228
Check paper and the printing environment .....	228
Use paper that meets HP specifications .....	228
Check the environment .....	229
Check the EconoMode settings .....	229
Try a different print driver .....	230
Set the individual tray alignment .....	231
Improve copy quality .....	232
Check the scanner glass for dirt or smudges .....	232
Calibrate the scanner .....	233
Check the paper settings .....	234
Check the paper size and type configuration .....	234
Select the tray to use for the copy .....	234
Check the image-adjustment settings .....	234
Optimize copy quality for text or pictures .....	234
Edge-to-edge copying .....	235
Clean the pickup rollers and separation pad in the document feeder .....	235
Improve scan quality .....	237
Check the scanner glass for dirt or smudges .....	237
Check the resolution settings .....	238
Check the image-adjustment settings .....	239
Optimize scan quality for text or pictures .....	239
Check the output-quality settings .....	239
Clean the pickup rollers and separation pad in the document feeder .....	240
Improve fax quality .....	242
Check the scanner glass for dirt or smudges .....	242
Check the send-fax resolution settings .....	243
Check the image-adjustment settings .....	244
Optimize fax quality for text or pictures .....	244
Check the error-correction settings .....	244
Send to a different fax machine .....	245
Clean the pickup rollers and separation pad in the document feeder .....	245
Check the fit-to-page setting .....	246

Check the sender's fax machine .....	247
The product does not print or it prints slowly .....	248
The product does not print .....	248
The product prints slowly .....	249
Solve easy-access USB printing problems .....	250
The Retrieve From USB Settings menu does not open when you insert the USB flash drive .....	250
The file does not print from the USB flash drive .....	250
The file that you want to print is not listed in the Retrieve from USB menu .....	251
Solve USB connection problems .....	252
Solve wired network problems .....	253
The product has a poor physical connection. ....	253
The computer is using the incorrect IP address for the product .....	253
The computer is unable to communicate with the product .....	254
The product is using incorrect link and duplex settings for the network .....	254
New software programs might be causing compatibility problems .....	254
The computer or workstation might be set up incorrectly .....	254
The product is disabled, or other network settings are incorrect .....	254
Solve fax problems .....	255
Checklist for solving fax problems .....	255
What type of phone line are you using? .....	255
Are you using a surge-protection device? .....	255
Are you using a phone company voice-messaging service or an answering machine? .....	256
Does your phone line have a call-waiting feature? .....	256
Check fax accessory status .....	256
General fax problems .....	257
Use Fax over VoIP networks .....	258
Problems with receiving faxes .....	258
Problems with sending faxes .....	260
Fax error codes .....	261
Fax error messages on the product control panel .....	261
Send-fax messages .....	263
Receive-fax messages .....	264
Service settings .....	264
Settings in the Troubleshooting menu .....	265
Solve product software problems (Windows) .....	266
A print driver for the product is not visible in the Printer folder .....	266
An error message was displayed during the software installation .....	266
The product is in Ready mode, but nothing prints .....	266
Solve product software problems (Mac OS X) .....	268



The product name does not appear in the product list in the Print & Fax or the Print & Scan list .....	268
A print job was not sent to the product that you wanted .....	268
When connected with a USB cable, the product does not appear in the Print & Fax or the Print & Scan list after the driver is selected .....	268
Remove software (Windows) .....	270
Remove the print driver (Mac OS X) .....	271

<b>Index .....</b>	<b>273</b>
--------------------	------------



---

# 1 Product introduction

- [Product views](#)
- [Control panel](#)
- [Product reports](#)

# Product views

## Product front view

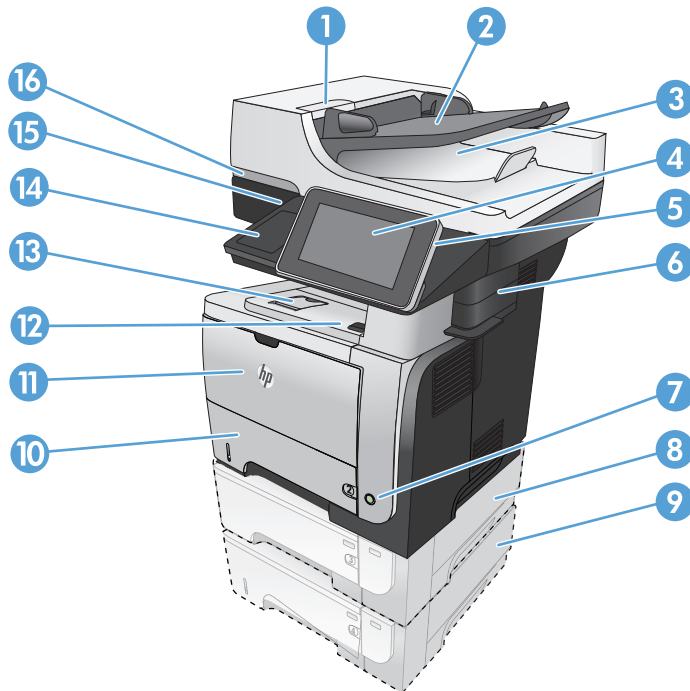

1	Latch to release the document-feeder cover (access for clearing jams)
2	Document-feeder input tray
3	Document-feeder output bin
4	Control panel with color touchscreen display
5	Home button (returns the product to the Home screen) <b>NOTE:</b> The button is on the side of the control panel.
6	Convenience stapler (M525f model only)
7	On/off button
8	Optional Tray 3
9	Optional Tray 4
10	Tray 2
11	Tray 1
12	Front-door-release button (access to the toner cartridge)
13	Standard output bin
14	Hardware integration pocket (for connecting third-party devices)

15	Easy-access USB port (for printing and scanning without a computer)
16	Handle to raise the scanner lid

## Product back view

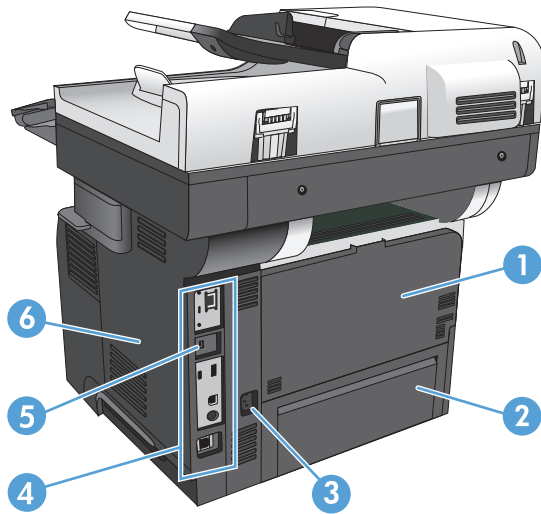

1	Rear door and face-up output bin (access for clearing jams)
2	Dust cover for Tray 2 (for printing on Legal-size paper)
3	Power connection
4	Formatter (contains the interface ports)
5	Slot for a cable-type security lock
6	Right-side cover (slide back for access to the formatter)

## Interface ports

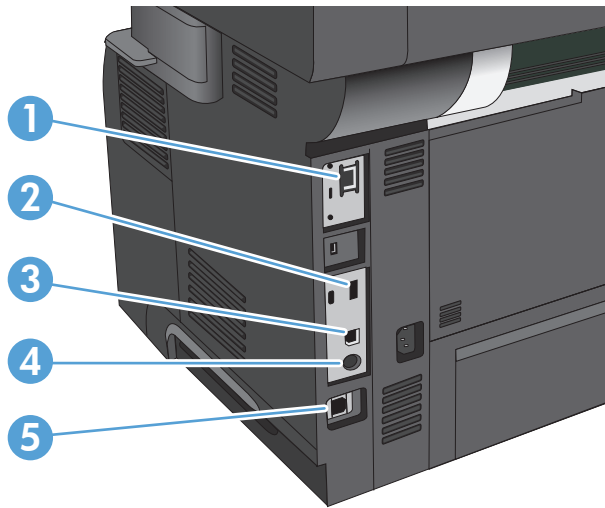

1	Local area network (LAN) Ethernet (RJ-45) network port
2	USB port for connecting external USB devices
3	Hi-Speed USB 2.0 printing port
4	Foreign interface harness (for connecting external devices)
5	Fax port (M525f model only)

## Serial number and model number location

The serial number and model number are listed on an identification label located on the back of the product. The serial number contains information about the country/region of origin, the product version, production code, and the production number of the product.

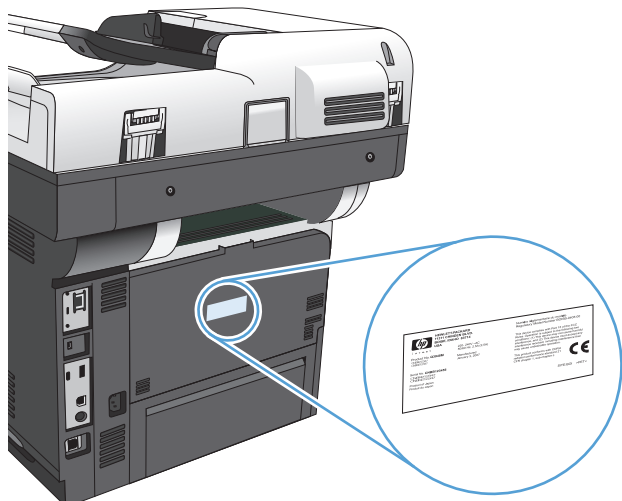

<b>Model name</b>	<b>Model number</b>
M525dn	CF116A
M525f	CF117A

# Control panel

## Control-panel Home screen

The Home screen provides access to the product features and indicates the current status of the product.

You can return to the Home screen at any time by pressing the Home button on the right side of the product control panel.

 **NOTE:** HP regularly updates features that are available in the product firmware. To take advantage of the most current features, upgrade the product firmware. To download the most recent firmware upgrade file, go to [www.hp.com/go/lj500MFPM525\\_firmware](http://www.hp.com/go/lj500MFPM525_firmware).

 **NOTE:** The features that appear on the Home screen can vary, depending on the product configuration.

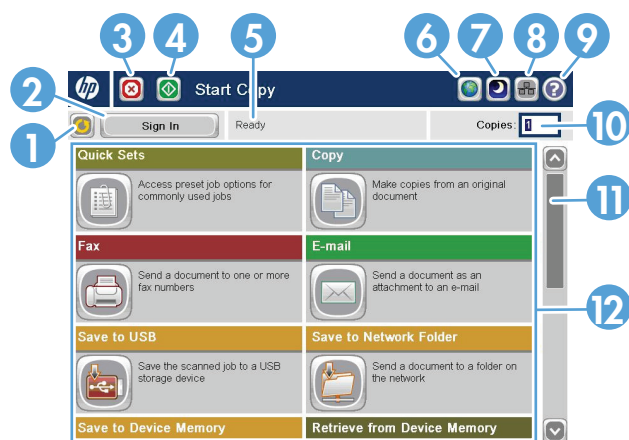

1	Refresh button	Touch the Refresh button to clear changes and restore the default settings.
2	Sign In or Sign Out	Touch the <b>Sign In</b> button to access secured features.  Touch the <b>Sign Out</b> button to sign out of the product if you have signed in for access to secured features. After you sign out, the product restores all options to the default settings.
3	Stop button	Touch the Stop button to pause the current job. The <b>Job Status</b> screen opens, and then you can cancel or continue the job.
4	Start button	Touch the Start button to start a copy job.
5	Product status	The status line provides information about the overall product status.
6	Language Selection button	Touch the Language Selection button to select the language for the control-panel display.
7	Sleep button	Touch the Sleep button to put the product into Sleep mode.
8	Network button	Touch the Network button to find information about the network connection.
9	Help button	Touch the Help button to open the embedded help system.
10	Copies field	The <b>Copies</b> field indicates the number of copies that the product is set to make.



---

11	Scroll bar	Touch the up or down arrows on the scroll bar to see the complete list of available features.
12	Features	Depending on the product configuration, the features that appear in this area can include any of the following items: <ul style="list-style-type: none"><li>• Quick Sets</li><li>• Copy</li><li>• E-mail</li><li>• Fax (for products that have fax installed)</li><li>• Save to USB</li><li>• Save to Network Folder</li><li>• Save to Device Memory</li><li>• Retrieve from USB</li><li>• Retrieve from Device Memory</li><li>• Job Status</li><li>• Supplies</li><li>• Trays</li><li>• Administration</li><li>• Device Maintenance</li></ul>

---

## Control-panel cleaning



Clean the control panel with a soft, lint-free cloth. Do not use paper towels or tissues because they are abrasive and could damage the screen. If necessary to remove stubborn debris, moisten the cloth with water or glass cleaner.

## Control-panel help

The product has a built-in Help system that explains how to use each screen. To open the Help system, touch the Help  button in the upper-right corner of the screen.

For some screens, the Help opens to a global menu where you can search for specific topics. You can browse through the menu structure by touching the buttons in the menu.

For screens that contain settings for individual jobs, the Help opens to a topic that explains the options for that screen.

If the product alerts you of an error or warning, touch the Error  button or the Warning  button to open a message that describes the problem. The message also contains instructions to help solve the problem.

You can print or view a report of the complete [Administration](#) menu so you can more easily navigate to the individual settings you need.

1. From the Home screen on the product control panel, scroll to and touch the [Administration](#) button.
2. Open the following menus:
  - [Reports](#)
  - [Configuration/Status Pages](#)
3. Select the [Administration Menu Map](#) option.
4. Touch the [Print](#) button to print the report. Touch the [View](#) button to view the report.

# Product reports

Product reports provide details about the product and its current configuration. Use the following procedure to print or view the reports:

1. From the Home screen on the product control panel, scroll to and touch the [Administration](#) button.
2. Open the [Reports](#) menu.
3. Select one of the report categories:
  - [Configuration/Status Pages](#)
  - [Fax Reports](#) (fax models only)
  - [Other Pages](#)
4. Select the name of the report you want to review, and then touch the [Print](#) button to print it or touch the [View](#) button to review the settings on the control-panel display.



**NOTE:** Some pages do not have the [View](#) option.

**Table 1-1** Reports menu

First level	Second level	Description
Configuration/Status Pages	Administration Menu Map	Shows the structure of the <a href="#">Administration</a> menu.
	Current Settings Page	Shows the current settings for each option in the <a href="#">Administration</a> menu.
	Configuration Page	Shows the product settings and installed accessories.
	Supplies Status Page	Shows the approximate remaining life for the supplies; reports statistics on total number of pages and jobs processed, serial number, page counts, and maintenance information.  HP provides approximations of the remaining life for the supplies as a customer convenience. The actual remaining supply levels might be different than the approximations provided.
	Usage Page	Shows a count of all paper sizes that have passed through the product; lists whether they were simplex or duplex, and reports the page count.
	File Directory Page	Shows the file name and folder name for files that are stored in the product memory.
Fax Reports	Web Services Status Page	Shows the detected Web Services for the product.
	Fax Activity Log	Contains a list of the faxes that have been sent from or received by this product.

**Table 1-1 Reports menu (continued)**

<b>First level</b>	<b>Second level</b>	<b>Description</b>
	Billing Codes Report	A list of billing codes that have been used for outgoing faxes. This report shows how many sent faxes were billed to each code.
	Blocked Fax List	A list of phone numbers that are blocked from sending faxes to this product.
	Speed Dial List	Shows the speed dials that have been set up for this product.
	Fax Call Report	A detailed report of the last fax operation, either sent or received.
Other Pages	PCL Font List	Prints the available PCL fonts.
	PS Font List	Prints the available HP postscript level 3 emulation fonts.

---

## 2 Connect the product and install software

- [Connect the product to a computer by using a USB cable and install the software \(Windows\)](#)
- [Connect the product to a network by using a network cable and install the software \(Windows\)](#)
- [Connect the product to a computer by using a USB cable and install the software \(Mac\)](#)
- [Connect the product to a network by using a network cable and install the software \(Mac\)](#)

# Connect the product to a computer by using a USB cable and install the software (Windows)

This product supports a USB 2.0 connection. Use an A-to-B type USB cable. HP recommends using a cable that is no longer than 2 m (6.5 ft).

**CAUTION:** Do not connect the USB cable until the installation software prompts you to connect it.

1. Close all open programs on the computer.
2. Install the software from the CD, and follow the on-screen instructions.
3. When prompted, select the **Directly connect to this computer using USB cable** option, and then click the **Next** button.
4. When the software prompts you, connect the USB cable to the product and the computer.

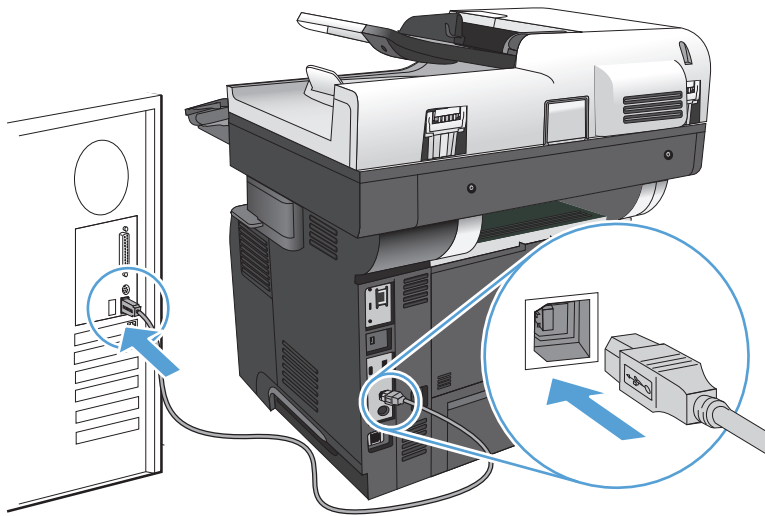



5. At the end of the installation, click the **Finish** button, or click the **More Options** button to install more software or configure basic digital sending features for the product.
6. Print a page from any program to make sure that the software is correctly installed.

# Connect the product to a network by using a network cable and install the software (Windows)

## Configure the IP address

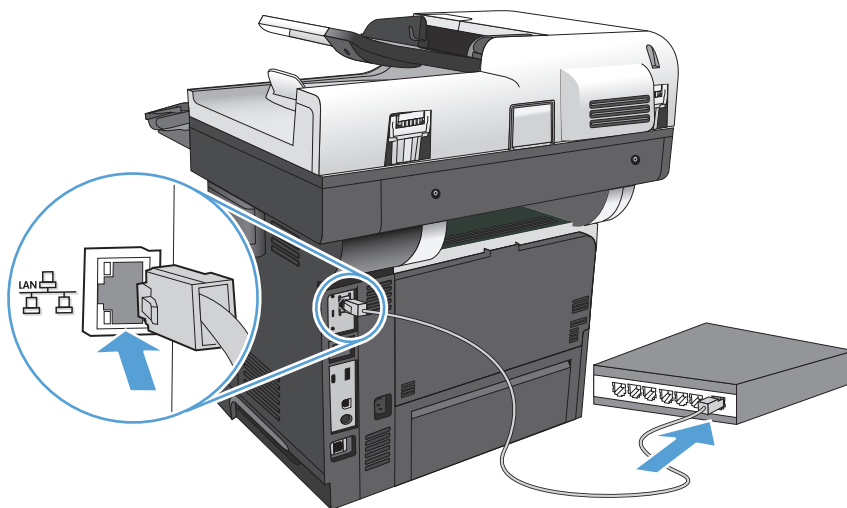
1. Make sure the product is turned on and that the **Ready** message displays on the product control-panel display.
2. Connect the network cable to the product and to the network.



3. Wait for 60 seconds before continuing. During this time, the network recognizes the product and assigns an IP address or host name for the product.
4. From the Home screen on the product control panel, touch the Network  button to identify the product IP address or host name.

If the Network  button is not visible, you can find the IP address or host name by printing a configuration page.

- a. From the Home screen on the product control panel, scroll to and touch the **Administration** button.
- b. Open the following menus:
  - **Reports**
  - **Configuration/Status Pages**
  - **Configuration Page**
- c. Touch the **View** button to view the information on the control panel, or touch the **Print** button to print the pages.

- d. Find the IP address on the Jetdirect page.

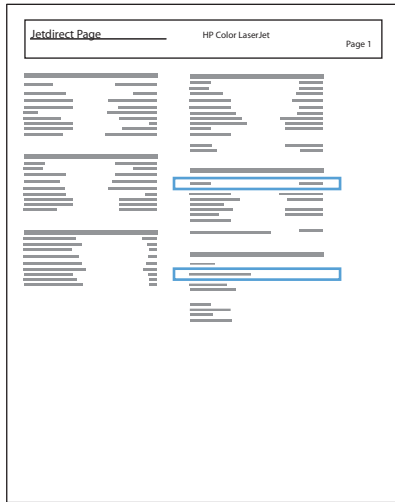

5. **IPv4:** If the IP address is 0.0.0.0, or 192.0.0.192, or 169.254.x.x, you must manually configure the IP address. Otherwise, the network configuration was successful.
- IPv6:** If the IP address begins with "fe80:", the product should be able to print. If not, you must manually configure the IP address.

## Install the software

1. Close all programs on the computer.
2. Install the software from the CD.
3. Follow the on-screen instructions.
4. When prompted, select the **Connect through a wired network** option.
5. From the list of available products, select the one that has the correct IP address. If the product is not listed, manually enter the product's IP Address, Host Name, or Hardware Address.
6. At the end of the installation, click the **Finish** button, or click the **More Options** button to install more software or configure basic digital sending features for the product.
7. Print a page from any program to make sure that the software is correctly installed.



## Connect the product to a computer by using a USB cable and install the software (Mac)

This product supports a USB 2.0 connection. Use an A-to-B type USB cable. HP recommends using a cable that is no longer than 2 m (6.5 ft).

1. Connect the USB cable to the product and the computer.

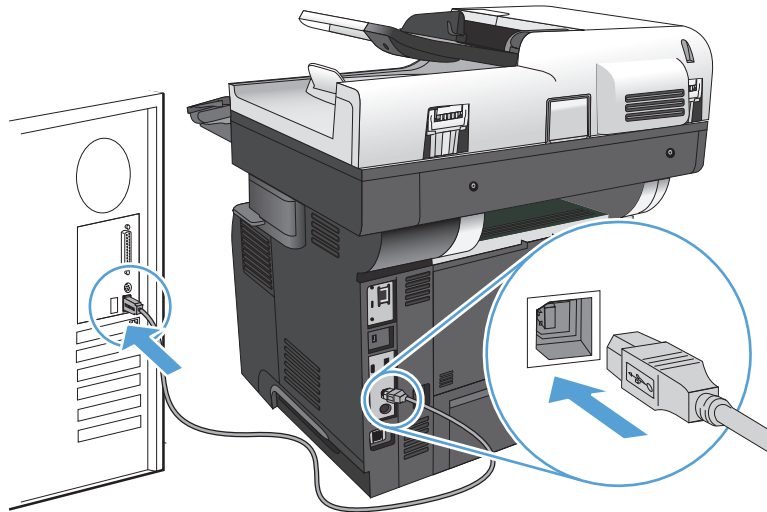



2. Install the software from the CD.
3. Click the product icon, and follow the on-screen instructions.
4. Click the **Close** button.
5. Print a page from any program to make sure that the software is correctly installed.

# Connect the product to a network by using a network cable and install the software (Mac)

## Configure the IP address

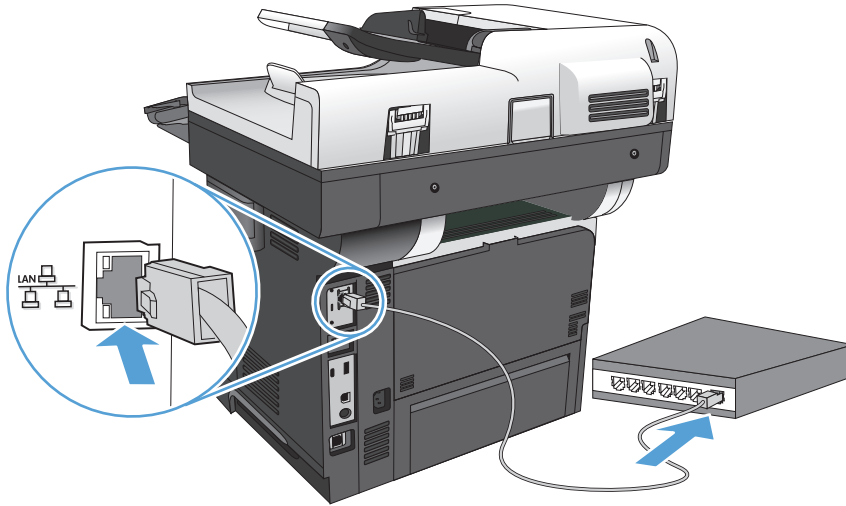
1. Make sure the product is turned on and that the **Ready** message displays on the product control-panel display.
2. Connect the network cable to the product and to the network.



3. Wait for 60 seconds before continuing. During this time, the network recognizes the product and assigns an IP address or host name for the product.
4. From the Home screen on the product control panel, touch the Network  button to identify the product IP address or host name.

If the Network  button is not visible, you can find the IP address or host name by printing a configuration page.

- a. From the Home screen on the product control panel, scroll to and touch the **Administration** button.
- b. Open the following menus:
  - **Reports**
  - **Configuration/Status Pages**
  - **Configuration Page**
- c. Touch the **View** button to view the information on the control panel, or touch the **Print** button to print the pages.

- d. Find the IP address on the Jetdirect page.

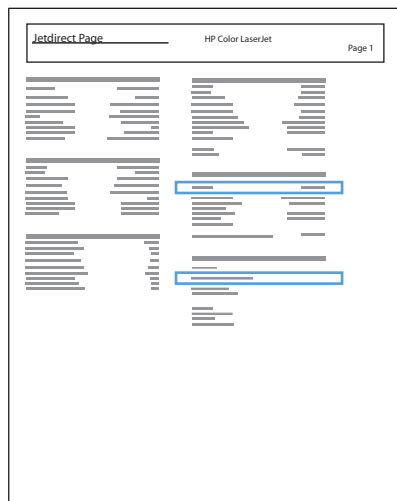

5. **IPv4:** If the IP address is 0.0.0.0, or 192.0.0.192, or 169.254.x.x, you must manually configure the IP address. Otherwise, the network configuration was successful.  
**IPv6:** If the IP address begins with "fe80:", the product should be able to print. If not, you must manually configure the IP address.

## Install the software

1. Close all programs on the computer.
2. Install the software from the CD.
3. Click the product icon, and follow the on-screen instructions.
4. Click the **Close** button when the installation is complete.



**NOTE:** Complete the following steps *after* completing the printing-system software installation *only* if you did not add a printer when running the installer.

5. At the computer, open the Apple  menu, click the **System Preferences** menu, and then click the **Print & Fax** icon (OS X v10.5 and 10.6) or the **Print & Scan** icon (OS X v10.7).
6. Click the plus symbol (+).
7. Use either Bonjour (default browser) or IP Printing for the network connection.



**NOTE:** Bonjour is the easiest and best method to use if the product is installed on your local network.

IP Printing *must* be used to install the product on a different network.

If you are using Bonjour, complete the following steps:

- a. Click the **Default Browser** tab.
- b. Select the product from the list. The software verifies that the product is connected to the network. The **Print Using** field is automatically populated with the correct PPD for the product.

---

 **NOTE:** If you are on a network that has more than one product, print a configuration page and match the Bonjour Printer Name to the name on the list to identify the product that you are installing.

 **NOTE:** If the product does not appear in the list, verify that the product is on and connected to the network, then try turning the product off and then on again. If the product PPD is not in the **Print Using** drop-down list, turn the computer off and then on again, and then restart the setup process.

---

- c. Click the **Add** button to complete the setup process.

If you are using the IP Printing method, complete the following steps:

- a. Click the **IP Printer** tab.
- b. Choose **HP Jet Direct – Socket** from the **Protocol** drop-down menu. This is the recommended setting for HP products.
- c. Type the IP address into the **Address** field on the add printer screen.
- d. The **Name**, **Location**, and **Print Using** information are automatically filled in. If the product PPD is not in the **Print Using** field, turn the computer off and then on again, and then restart the setup process.

---

## 3 Input trays and output bins

- [Supported paper sizes](#)
- [Supported paper types](#)
- [Configure trays](#)
- [Alternative letterhead mode](#)
- [Tray 1](#)
- [Tray 2 and the optional 500-sheet trays](#)
- [Use paper output options](#)
- [Use the convenience stapler \(stapling models only\)](#)

# Supported paper sizes



**NOTE:** To obtain the best results, select the correct paper size and type in the print driver before printing.

**Table 3-1 Supported paper sizes**

Size and dimensions	Tray 1	Tray 2 and the optional 500-sheet trays	Automatic duplex printing
Letter 216 x 279 mm (8.5 x 11 in)	✓	✓	✓
Legal 216 x 356 mm (8.5 x 14 in)	✓	✓	✓
Executive 184 x 267 mm (7.25 x 10.5 in)	✓	✓	
Statement 140 x 216 mm (5.5 x 8.5 in)	✓	✓	
Oficio 8.5 x 13 216 x 330 mm (8.5 x 13 in)	✓	✓	✓
Oficio 216 x 340 216 x 340 mm (8.5 x 13.4 in)	✓	✓	✓
3 x 5 76 x 127 mm (3 x 5 in)	✓		
4 x 6 102 x 152 mm (4 x 6 in)	✓		
5 x 7 127 x 178 mm (5 x 7 in)	✓	✓	
5 x 8 127 x 203 mm (5 x 8 in)	✓	✓	
A4 210 x 297 mm (8.3 x 11.7 in)	✓	✓	✓
A5 148 x 210 mm (5.8 x 8.3 in)	✓	✓	
A6 104 x 147 mm (4.1 x 5.8 in)	✓	✓	

**Table 3-1 Supported paper sizes (continued)**

Size and dimensions	Tray 1	Tray 2 and the optional 500-sheet trays	Automatic duplex printing
RA4 215 x 305 mm (8.5 x 12.0 in)	✓	✓	✓
B5 (JIS) 183 x 257 mm (7.2 x 10.1 in)	✓	✓	
B6 (JIS) 128 x 182 mm (5.0 x 7.2 in)	✓	✓	
10 x 15 cm 102 x 152 mm (4 x 6 in)	✓		
16K 184 x 260 mm (7.2 x 10.25 in)	✓	✓	
16K 195 x 270 mm (7.7 x 10.6 in)	✓	✓	
16K 197 x 273 mm (7.75 x 10.75 in)	✓	✓	
Postcard (JIS) 100 x 148 mm (3.9 x 5.8 in)	✓		
D Postcard (JIS) 200 x 1480 mm (7.9 x 5.8 in)	✓	✓	
Custom 76 x 127 mm to 216 x 356 mm (3.0 x 5.0 in to 8.5 x 14 in)	✓		
Custom 105 x 148 mm to 216 x 356 mm (4.1 x 5.8 in to 8.5 x 14 in)		✓	
Custom 210 x 280 mm to 216 x 356 mm (8.3 x 11 in to 8.5 x 14 in)			✓
Envelope #9 98 x 225 mm (3.9 x 8.9 in)	✓		
Envelope #10 105 x 241 mm (4.1 x 9.5 in)	✓		

**Table 3-1 Supported paper sizes (continued)**

<b>Size and dimensions</b>	<b>Tray 1</b>	<b>Tray 2 and the optional 500-sheet trays</b>	<b>Automatic duplex printing</b>
Envelope DL 110 x 220 mm (4.3 x 8.7 in)	✓		
Envelope C5 162 x 229 mm (6.4 x 9.8 in)	✓		
Envelope B5 176 x 250 mm (6.9 x 9.8 in)	✓		
Envelope Monarch 98 x 191 mm (3.9 x 7.5 in)	✓		
Envelope C6 114 x 162 mm (4.5 x 6.4 in)	✓		



# Supported paper types

For a complete list of specific HP-brand paper that this product supports, go to [www.hp.com/support/lj500MFP525](http://www.hp.com/support/lj500MFP525).

 **NOTE:** To obtain the best results, select the correct paper size and type in the print driver before printing.

**Table 3-2 Supported paper types**

Paper type	Tray 1	Tray 2 and optional 500-sheet trays	Automatic duplex printing
Plain	✓	✓	✓
HP EcoSMART Lite	✓	✓	✓
Light 60–74 g/m <sup>2</sup>	✓	✓	✓
Midweight 96–110 g/m <sup>2</sup>	✓	✓	✓
Heavy 111–130 g/m <sup>2</sup>	✓	✓	✓
Extra Heavy 131–175 g/m <sup>2</sup>	✓		
Cardstock 176–220 g/m <sup>2</sup>	✓		
Mono Transparency	✓		
Labels	✓	✓	
Letterhead	✓	✓	✓
Envelope	✓		
Preprinted	✓	✓	✓
Prepunched	✓	✓	✓
Colored	✓	✓	✓
Bond	✓	✓	✓
Recycled	✓	✓	✓
Rough	✓	✓	

# Configure trays

The product automatically prompts you to configure a tray for type and size in the following situations:

- When you load paper into the tray
- When you specify a particular tray or paper type for a print job through the print driver or a software program and the tray is not configured to match the print-job's settings



**NOTE:** The prompt does not display if you are printing from Tray 1, and Tray 1 is configured for the **Any Size** paper size and the **Any Type** paper type settings. In this situation, if the print job does not specify a tray, the product prints from Tray 1, even if the paper size and type settings in the print job do not match the paper loaded in Tray 1.

## Configure a tray when loading paper

1. Load paper in the tray. Close the tray if you are using Tray 2 and 3.
2. The tray configuration message displays on the product control panel.
3. Touch the **OK** button to accept the detected size and type, or touch the **Modify** button to choose a different paper size or type.
4. Select the correct size and type, and then touch the **OK** button.

## Configure a tray to match print job settings

1. In the software program, specify the source tray, the paper size, and the paper type.
2. Send the job to the product.  
If the tray needs to be configured, a tray configuration message displays on the product control panel.
3. Load the tray with the specified type and size of paper, and then close the tray.
4. Touch the **OK** button to accept the detected size and type, or touch the **Modify** button to choose a different paper size or type.
5. Select the correct size and type, and then touch the **OK** button.

## Configure a tray by using the control panel

You can also configure the trays for type and size without a prompt from the product.

1. From the Home screen on the product control panel, scroll to and touch the **Trays** button.
2. Touch the line for the tray that you want to configure, and then touch the **Modify** button.
3. Select the paper size and paper type from the lists of options.
4. Touch the **OK** button to save your selection.

# Alternative letterhead mode

Use the [Alternative Letterhead Mode](#) feature so that you can load letterhead or preprinted paper into the tray the same way for all print or copy jobs, whether you are printing or copying to one side of the sheet of paper or to both sides. When using this mode, load paper the same way you would for automatic duplex printing.

To use the feature, enable it by using the product control-panel menus. To use the feature with Windows, you also need to enable the feature in the print driver and configure the paper type in the print driver.

## Enable Alternative Letterhead Mode by using the product control-panel menus

1. From the Home screen on the product control panel, scroll to and touch the [Administration](#) button.
2. Open the following menus:
  - [Manage Trays](#)
  - [Alternative Letterhead Mode](#)
3. Touch the [Enable](#) option.

To print with Alternative Letterhead Mode for Windows, perform the following procedure for each print job.

## Print with Alternative Letterhead Mode (Windows)

1. From the software program, select the **Print** option.
2. Select the product, and then click the **Properties** or **Preferences** button.
3. Click the **Advanced** tab.
4. Expand the **Printer Features** list.
5. Open the **Alternative Letterhead Mode** drop-down list, and click the **On** option.
6. Click the **Apply** button.
7. Click the **Paper/Quality** tab.
8. From the **Paper type** drop-down list, click the **More...** option.
9. Expand the list of **Type is:** options.
10. Expand the list of **Other** options, and then click the **Letterhead** option. Click the **OK** button.
11. Click the **OK** button to close the **Document Properties** dialog box. In the **Print** dialog box, click the **OK** button to print the job.

# Tray 1

## Tray capacity and paper orientation

To prevent jams, do not overfill trays. Be sure the top of the stack is below the tray-full indicator. For short/narrow and heavy/glossy paper, load paper to less than half of the tray full indicators.

**Table 3-3 Tray 1 capacity**

Paper type	Specifications	Quantity
Paper	Range: 60 g/m <sup>2</sup> (16 lb) to 220 g/m <sup>2</sup> (58 lb)	Maximum stack height: 12 mm (0.5 in) Equivalent to 100 sheets of 75 g/m <sup>2</sup> (20 lb)
Envelopes	75 g/m <sup>2</sup> (20 lb) to 90 g/m <sup>2</sup> (24 lb)	Up to 10 envelopes
Labels	0.10 to 0.14 mm (0.004 to 0.006 in) thick	Maximum stack height: 12 mm (0.5 in)
Transparencies	0.10 to 0.14 mm (0.004 to 0.006 in) thick	Maximum stack height: 12 mm (0.5 in)

**Table 3-4 Tray 1 paper orientation**

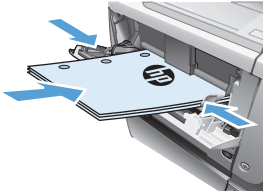
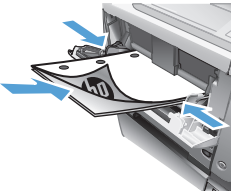
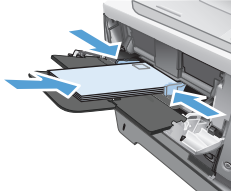
Single-sided printing	Automatic duplex printing and Alternative Letterhead Mode	Envelopes
Face-up	Face-down	Face-up
Top edge leading into the product	Bottom edge leading into the product	Short, postage end leading into the product
		

## Load Tray 1

1. Open Tray 1.

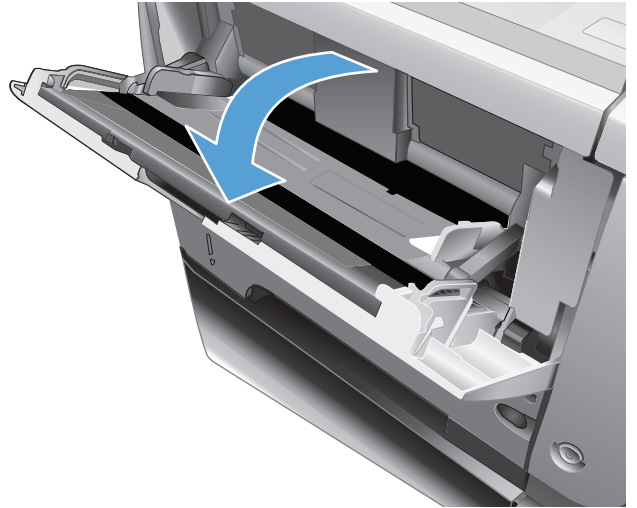

2. Pull out the paper support and flip open the extension.

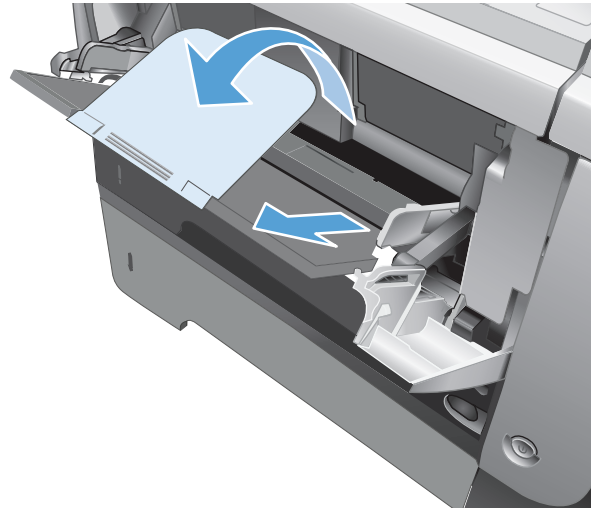

3. Load the paper into the tray. Make sure that the paper fits under the tabs and below the maximum-height indicators.

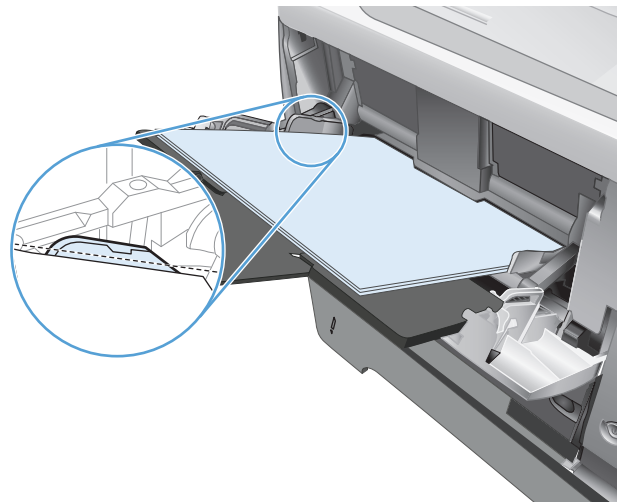

4. Adjust the side guides so that they lightly touch the paper stack but do not bend the paper.

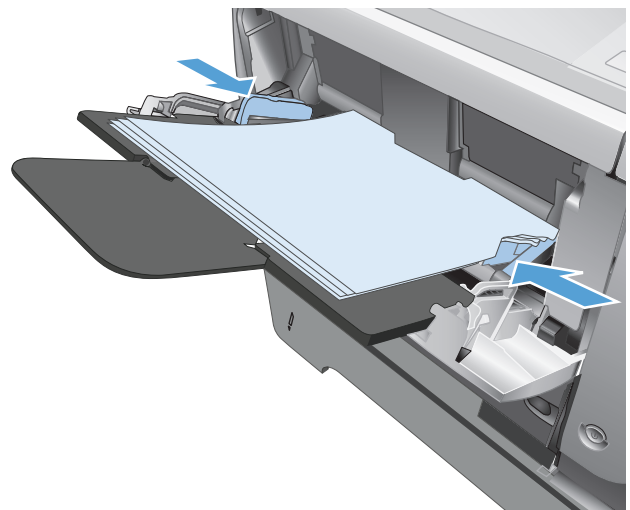

# Tray 2 and the optional 500-sheet trays

## Tray capacity and paper orientation

To prevent jams, do not overfill trays. Be sure the top of the stack is below the tray-full indicator. For short/narrow and heavy/glossy paper, load paper to less than half of the tray-full indicators.

**Table 3-5 Tray 2 and the optional 500-sheet trays capacity**

Paper type	Specifications	Quantity
Paper	Range:  60 g/m <sup>2</sup> (16 lb) to 130 g/m <sup>2</sup> (35 lb)	Equivalent to 500 sheets of 75 g/m <sup>2</sup> (20 lb)

**Table 3-6 Tray 2 and the optional 500-sheet trays paper orientation**

Single-sided printing	Automatic duplex printing and Alternative Letterhead Mode	Envelopes
Face-down Top edge at the front of the tray	Face-up Bottom edge at the front of the tray	Print envelopes only from Tray 1.

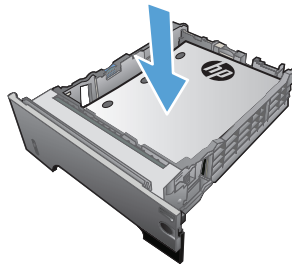
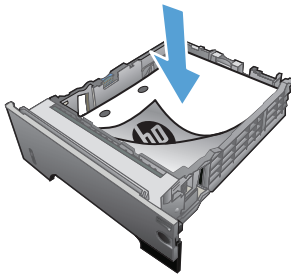

## Load Tray 2 or the optional 500-sheet trays

1. Pull the tray out and lift up slightly to remove it completely from the product.

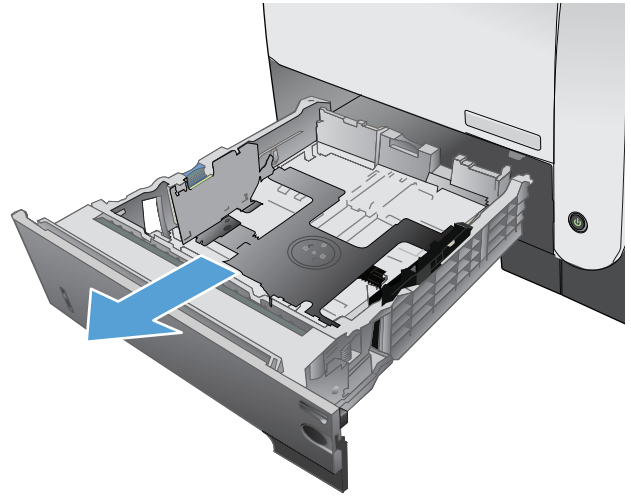

2. Pinch the release that is located on the left guide and slide the side guides to the correct paper size.

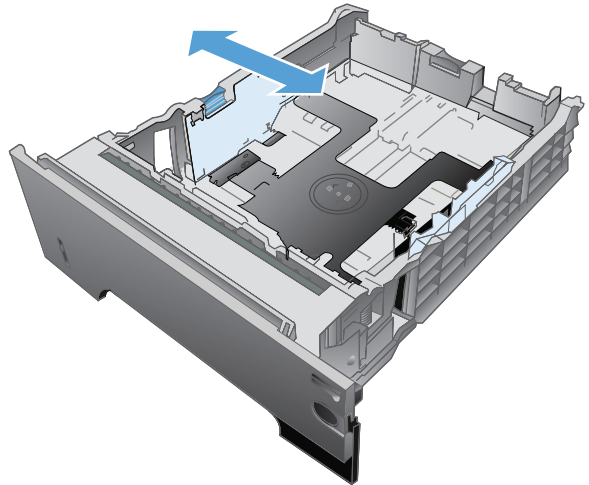

3. Pinch the release that is located on the rear paper guide and slide it to the correct paper size.

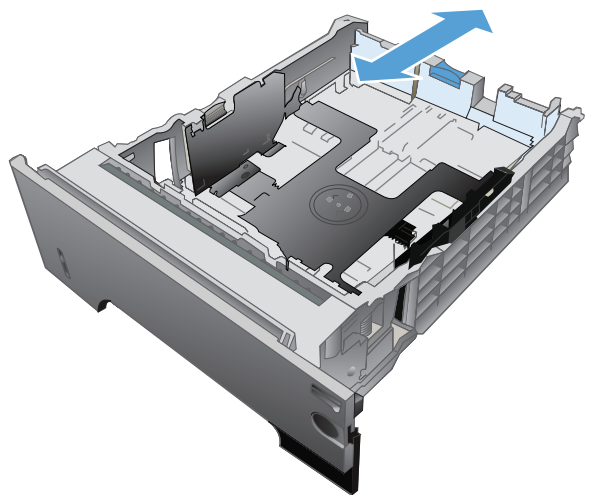



4. Load the paper into the tray. Make sure that the stack is flat at all four corners and that the top of the stack is below the maximum-height indicators.

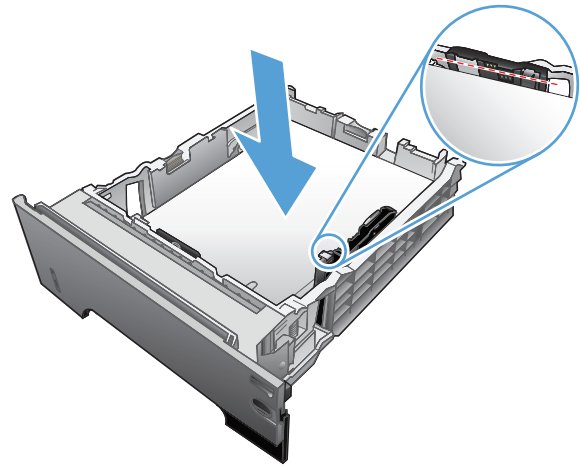

5. Slide the tray completely into the product.

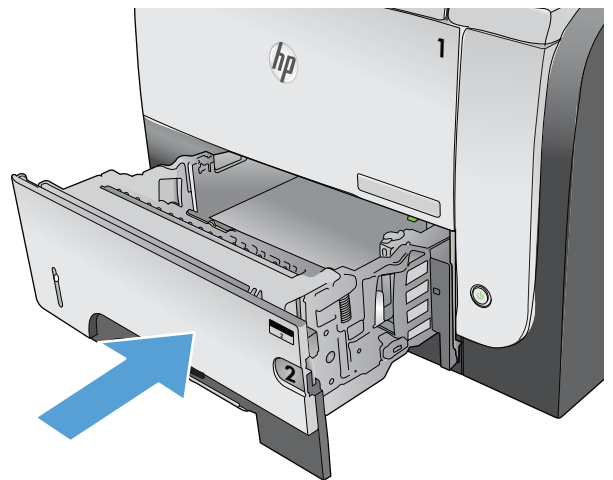

# Use paper output options

## Print to the standard output bin

The standard output bin collects paper face-down, in the correct order. Use this bin for most print jobs, including transparencies. To use the standard output bin, be sure that the rear output bin is closed. To avoid jams, do not open or close the rear output bin while the product is printing.

The standard output bin holds up to 250 sheets of 75 g/m<sup>2</sup> (20 lb) paper.

## Print to the rear output bin

The product always prints to the rear output bin if it is open. Paper that is printed to this bin will exit face-up, with the last page on top (reverse order).

The rear output bin holds up to 50 sheets of 75 g/m<sup>2</sup> (20 lb) paper.

Printing from Tray 1 to the rear output bin provides the straightest path. Opening the rear output bin might improve performance with the following items:

- Envelopes
- Labels
- Small custom-size paper
- Postcards
- Paper heavier than 120 g/m<sup>2</sup> (32 lb)

To open the rear output bin, grasp the handle at the top of the bin. Pull the bin down to a 45° angle, and slide out the extension.

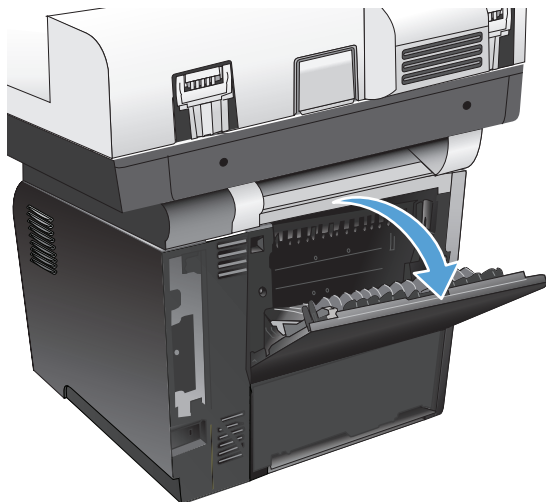

 **NOTE:** Opening the rear output bin makes the duplexer and the top output bin unavailable. To avoid jams, do not open or close the rear output bin while the product is printing.

## Use the convenience stapler (stapling models only)

Activate the stapling mechanism by inserting paper into the convenience stapler.

1. Insert up to 20 sheets of paper that weighs up to 75 g/m<sup>2</sup> (20 lb) into the slot in the stapler door. Insert fewer sheets to staple if the paper weight is heavier than 75 g/m<sup>2</sup> (20 lb).

**CAUTION:** Do not use the convenience stapler to staple plastic, cardboard, or wood. Damage to the convenience stapler can result from attempting to staple these materials.

**NOTE:** Exceeding the recommended capacity can result in jams or damage.

2. Wait for the stapler to staple the sheets. When it is inserted all the way into the stapler slot, the paper should trigger the stapler mechanism.

3. Remove the stapled paper from the slot.

**NOTE:** If you are unable to remove the paper after stapling, carefully open the stapler door and then slide your document out.

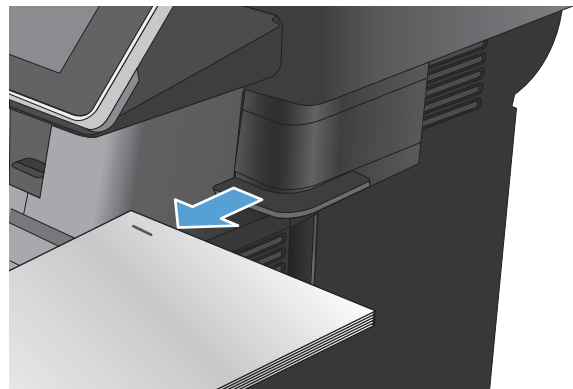
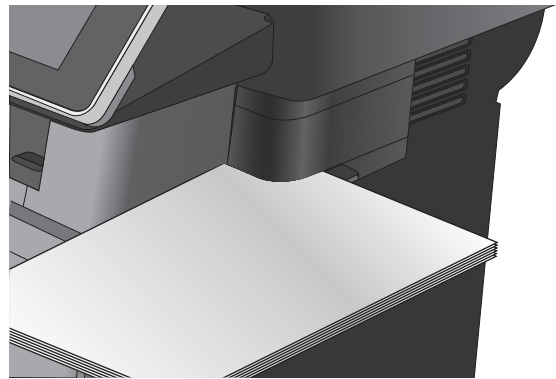
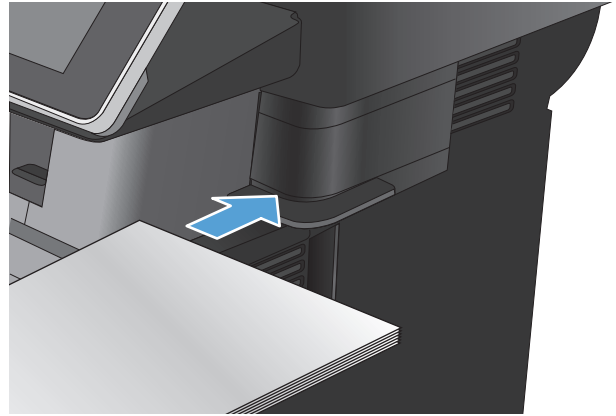



---

## 4 Parts, supplies, and accessories

- [Order parts, accessories, and supplies](#)
- [HP policy on non-HP supplies](#)
- [HP anticounterfeit Web site](#)
- [Print when a toner cartridge is at estimated end of life](#)
- [Enable or disable the Very Low Settings options from the control panel](#)
- [Customer self-repair parts](#)
- [Accessories](#)
- [Toner cartridge](#)
- [Staples \(stapling models only\)](#)

# Order parts, accessories, and supplies

---

Order supplies and paper	<a href="http://www.hp.com/go/suresupply">www.hp.com/go/suresupply</a>
Order genuine HP parts or accessories	<a href="http://www.hp.com/buy/parts">www.hp.com/buy/parts</a>
Order through service or support providers	Contact an HP-authorized service or support provider.
Order using HP software	The HP Embedded Web Server contains a link to the HP SureSupply Web site, which provides options for purchasing Original HP supplies.

---

## HP policy on non-HP supplies

Hewlett-Packard Company cannot recommend the use of non-HP toner cartridges, either new or remanufactured.

---

 **NOTE:** For HP printer products, the use of a non-HP toner cartridge or a refilled toner cartridge does not affect either the warranty to the customer or any HP support contract with the customer. However, if product failure or damage is attributable to the use of a non-HP toner cartridge or refilled toner cartridge, HP will charge its standard time and materials charges to service the product for the particular failure or damage.

---

## HP anticounterfeit Web site

Go to [www.hp.com/go/anticounterfeit](http://www.hp.com/go/anticounterfeit) when you install an HP toner cartridge and the control-panel message says the cartridge is non-HP. HP will help determine if the cartridge is genuine and take steps to resolve the problem.

Your toner cartridge might not be a genuine HP toner cartridge if you notice the following:

- The supplies status page indicates that a non-HP supply is installed.
- You are experiencing a high number of problems with the cartridge.
- The cartridge does not look like it usually does (for example, the packaging differs from HP packaging).



# Print when a toner cartridge is at estimated end of life

---

**<Supply> Low**

This message displays when a supply is nearing the estimated end of its useful life.

---

**<Supply> Very Low**

This message displays when a supply is at its estimated end of useful life. Print-quality problems can occur when using a supply that is at its estimated end of life.

---

# Enable or disable the Very Low Settings options from the control panel

You can enable or disable the default settings at any time, and you do not have to re-enable them when you install a new cartridge.

1. From the Home screen on the product control panel, scroll to and touch the [Administration](#) button.
2. Open the following menus:
  - [Manage Supplies](#)
  - [Supply Settings](#)
  - [Black Cartridge](#)
3. Select one of the following options:
  - Select the [Stop](#) option to set the product to stop printing (including printing faxes) until you replace the cartridge.
  - Select the [Prompt to continue](#) option to set the product to stop printing (including printing faxes) and prompt you to replace the cartridge. You can acknowledge the prompt and continue printing.
  - Select the [Continue](#) option to set the product to alert you that the cartridge is very low, but to continue printing.



---

**NOTE:** Using the [Continue](#) setting allows printing beyond Very Low without customer interaction and can result in unsatisfactory print quality.

---

If you select the [Stop](#) or [Prompt to continue](#) option, the product stops printing when it reaches the Very Low threshold. When you replace the cartridge, the product automatically resumes printing.

When the product is set to the [Stop](#) or [Prompt to continue](#) option, there is some risk that faxes will not print when the product resumes printing. This can occur if the product has received more faxes than the memory can hold while the product is waiting.

The product can print faxes without interruption when it passes the Very Low threshold if you select the [Continue](#) option for the toner cartridge, but print quality might degrade.

Once an HP supply has reached Very Low, HP's premium Protection Warranty on that supply has ended.

# Customer self-repair parts

The following customer self-repair parts are available for the product.

- Parts listed as **Mandatory** self-replacement are to be installed by customers, unless you are willing to pay HP service personnel to perform the repair. For these parts, on-site or return-to-depot support is not provided under the HP product warranty.
- Parts listed as **Optional** self-replacement can be installed by HP service personnel at your request for no additional charge during the product warranty period.

 **NOTE:** For more information, go to [www.hp.com/go/learnaboutsupplies](http://www.hp.com/go/learnaboutsupplies).

**Table 4-1 Customer self-repair parts**

Item	Description	Self-replacement options	Part number
Fax kit (fax models only)	Replacement fax accessory	Mandatory	CF116-67904
Control-panel kit	Control panel replacement kit	Mandatory	CD644-67916
Control-panel HIP (Hardware Integration Pocket)	Hardware integration pocket for the product control panel	Mandatory	5042-8976
Control-panel USB cover	Cover for the USB port on the product control panel	Mandatory	5042-8977
Document-feeder roller maintenance kit	Roller maintenance kit for the document feeder	Mandatory	L2725-60002
Foam-reflector kit	Replacement white backing under the scanner lid	Optional	5851-4878
Document-feeder separation-pad spring	Replacement spring for the document-feeder separation pad	Optional	5851-4879
SSM Solid state module	Replacement memory module for the M525dn model	Optional	CF116-67916
Hard disk drive kit	Replacement HP High-Performance Secure Hard Disk for the M525f model	Optional	CF116-67907
Hard disk drive kit	Replacement HP High-Performance Secure Hard Disk (Government option)	Optional	CF116-67915
Fax cable	Replacement cable – Israel	Mandatory	8120-8913
Fax cable	Replacement cable – Switzerland	Mandatory	8121-0844
Fax cable	Replacement cable – Rest of the World	Mandatory	8121-0811
Toner cartridge	Standard capacity	Mandatory	CE255A
Toner cartridge	High capacity	Mandatory	CE255X
Cassette assembly	Replacement cassette assembly	Mandatory	RM1-8512-000CN

**Table 4-1 Customer self-repair parts (continued)**

<b>Item</b>	<b>Description</b>	<b>Self-replacement options</b>	<b>Part number</b>
500-sheet feeder CE530A	Complete 500-sheet feeder for Tray 3 or Tray 4  Includes cassette	Mandatory	CF116-67911
MFP Stand CF338A	MFP Stand	Mandatory	CF116-67919
Power cable 220V – 10A	Replacement cable – China	Mandatory	8121-0943
Power cable 110V – 13A	Replacement cable – Taiwan	Mandatory	8121-0964
Power cable 220V – 10A	Replacement cable – Korea, EU generic	Mandatory	8121-0731
Power cable 110V – 12A	Replacement cable – Japan	Mandatory	8121-1143
Power cable 220V – 6A	Replacement cable – India	Mandatory	8121-0564
Power cable 220V – 10A	Replacement cable – UK/Asia Pacific	Mandatory	8121-0739
Power cable 220V – 10A	Replacement cable – Australia/New Zealand	Mandatory	8121-0837
Power cable 220V – 10A	Replacement cable – Israel	Mandatory	8121-1004
Power cable 220V – 10A	Replacement cable – Denmark	Mandatory	8121-0733
Power cable 220V – 10A	Replacement cable – South Africa	Mandatory	8121-0737
Power cable 220V – 10A	Replacement cable – Switzerland	Mandatory	8121-0738
Power cable 110V – 10A Brazil	Replacement cable – Brazil	Mandatory	8121-1071
Power cable 220V – 10A Argentina	Replacement cable – Argentina	Mandatory	8121-0729
Power cable 110V – 13A North America	Replacement cable – North America	Mandatory	8121-0740
Power cable 220V – 10A South America/Chile/Peru	Replacement cable – South America/Chile/Peru	Mandatory	8121-0735
Power cable 220V / 110V – Thailand/Phillipines	Replacement cable – Thailand/Phillipines	Mandatory	8121-0734

# Accessories

<b>Item</b>	<b>Description</b>	<b>Part number</b>
Optional 500-sheet tray and feeder unit	Optional tray to increase paper capacity.  The product can accommodate up to two optional 500-sheet feeders.	CE530A
HP LaserJet MFP Analog Fax Accessory 500	Provides fax capability for the product. Included with the M525f model.	CF116-67904
MFP Stand	A storage cabinet that is installed beneath the product.	CF338A

## Toner cartridge

- [Toner cartridge view](#)
- [Toner cartridge information](#)
- [Replace the toner cartridge](#)

## Toner cartridge view

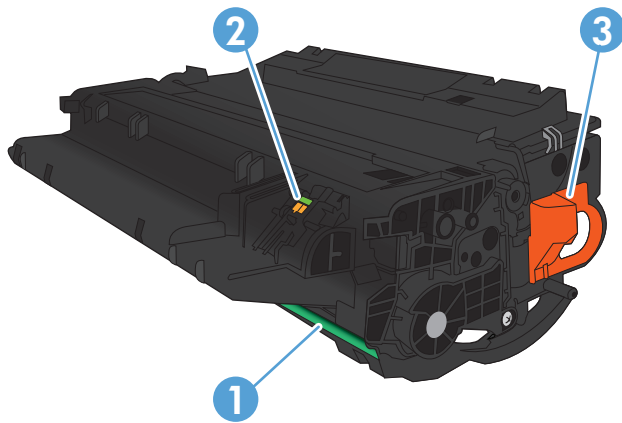

1	Imaging drum <b>CAUTION:</b> Do not touch the shutter or the surface of the roller. Doing so can damage the cartridge.
2	Memory chip
3	Pull tab for the sealing tape

## Toner cartridge information

Capacity	Cartridge number	Part number
Standard-capacity replacement black toner cartridge	55A	CE255A
High-capacity replacement black toner cartridge	55X	CE255X

For more information about supplies, go to [www.hp.com/go/learnaboutesupplies](http://www.hp.com/go/learnaboutesupplies).

The information contained herein is subject to change without notice. For the latest supplies information go to [www.hp.com/go/lj500MFPM525\\_manuals](http://www.hp.com/go/lj500MFPM525_manuals).

## Recycle toner cartridge

To recycle a genuine HP toner cartridge, place the used cartridge in the box in which the new cartridge arrived. Use the enclosed return label to send the used supply to HP for recycling. For complete information, see the recycling guide that is included with each new HP supply item.

## Toner-cartridge storage

Do not remove the toner cartridge from its package until you are ready to use it.

 **CAUTION:** To prevent damage to the toner cartridge, do not expose it to light for more than a few minutes.

## HP policy on non-HP toner cartridges

Hewlett-Packard Company cannot recommend the use of non-HP toner cartridges, either new or remanufactured.

 **NOTE:** Any damage caused by a non-HP toner cartridge is not covered under the HP warranty and service agreements.



## Replace the toner cartridge

**CAUTION:** If toner gets on clothing, wipe it off by using a dry cloth and wash the clothes in cold water. Hot water sets toner into fabric.

**NOTE:** Information about recycling used toner cartridges is on the toner-cartridge box.

1. Press the front-door-release button.



2. Open the front door.



3. Remove the used toner cartridge from the product.



4. Remove the new toner cartridge from the bag. Place the used toner cartridge in the bag for recycling.

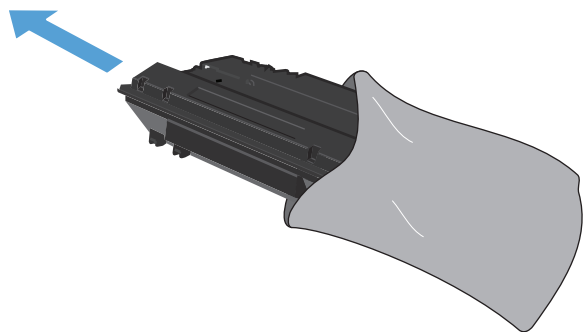

5. Grasp the front and back of the toner cartridge, and distribute the toner by gently rocking the toner cartridge five or six times.

**CAUTION:** Do not touch the shutter or the surface of the roller.

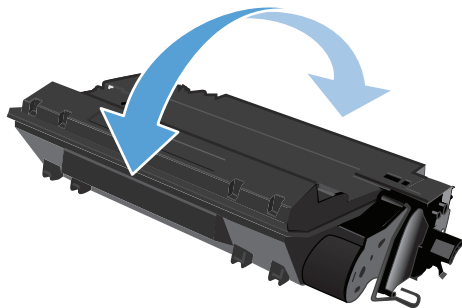

6. Remove the shipping tape from the new toner cartridge. Recycle the tape with the used toner cartridge.

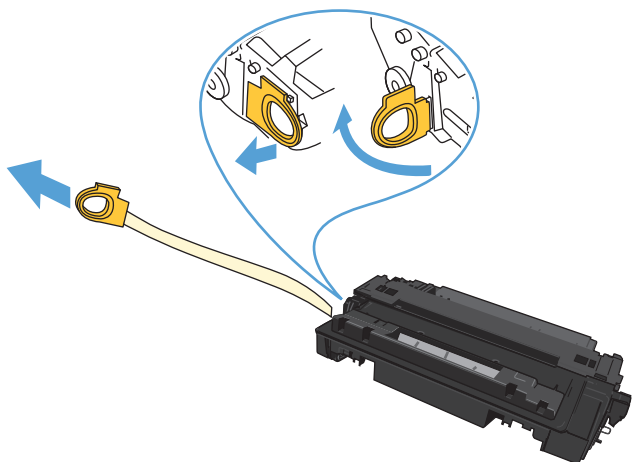

7. Align the toner cartridge with the tracks inside the product, and insert the toner cartridge until it is firmly seated.

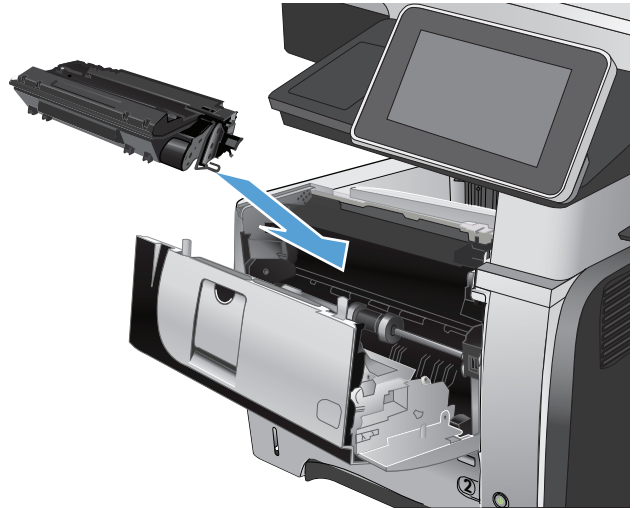

8. Close the front cover. After a short time, the control panel should display the **Ready** message.



# Staples (stapling models only)

Item	Description	Part number
Staple cartridge	Pack of two staple cartridges. Each cartridge holds 1,500 unformed staples.	Q7432A

For more information, go to [www.hp.com/go/learnaboutesupplies](http://www.hp.com/go/learnaboutesupplies).

## Load staples

1. Open the stapler door.

**NOTE:** Opening the stapler door disables the stapler.

Instructions and replacement staples part numbers are listed on the stapler door.

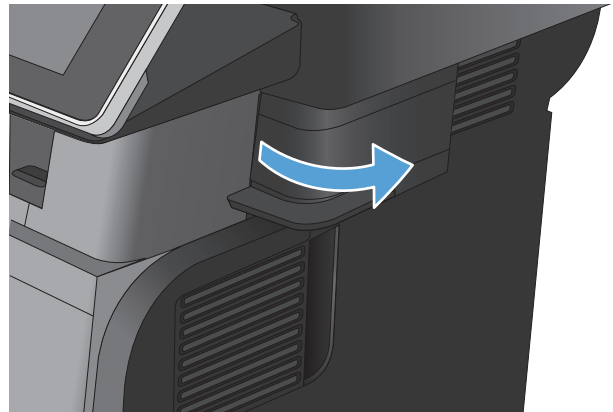

2. If you are replacing a staple cartridge (for example, if the staple cartridge has run out of staples), remove the staple cartridge from the product.

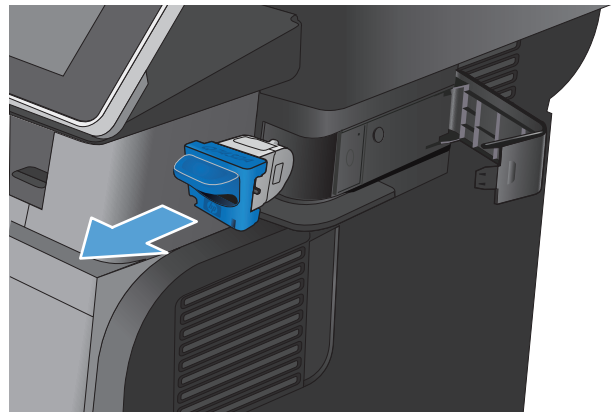

3. Insert a new staple cartridge into the opening inside the stapler door.

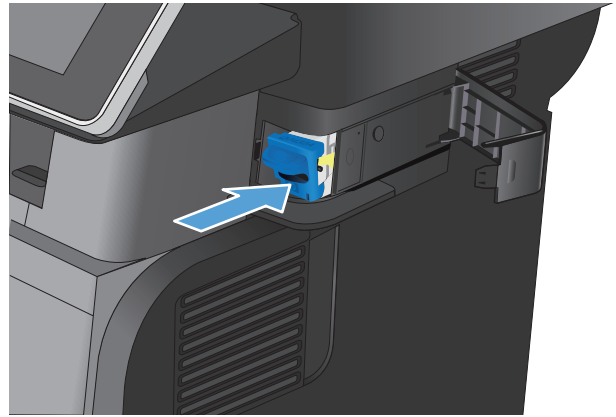

4. Close the stapler door.

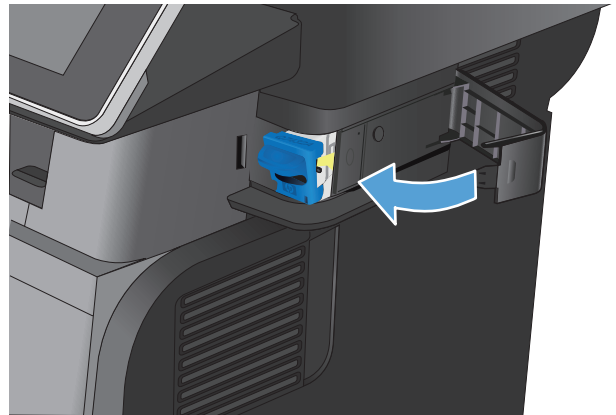



---

# 5 Print

- [Supported print drivers \(Windows\)](#)
- [Change print-job settings \(Windows\)](#)
- [Change print-job settings \(Mac OS X\)](#)
- [Print tasks \(Windows\)](#)
- [Print tasks \(Mac OS X\)](#)
- [Additional print tasks \(Windows\)](#)
- [Additional print tasks \(Mac OS X\)](#)
- [Store print jobs on the product](#)
- [Add a job-separator page \(Windows\)](#)
- [Use HP ePrint](#)
- [Use the HP ePrint Mobile Driver](#)
- [Use Apple AirPrint](#)
- [Use HP Smart Print \(Windows\)](#)
- [Use easy-access USB printing](#)

# Supported print drivers (Windows)

Print drivers provide access to the product features and allow the computer to communicate with the product (using a printer language). The following print drivers are available at [www.hp.com/go/lj500MFPM525\\_software](http://www.hp.com/go/lj500MFPM525_software).

---

## HP PCL 6 driver

- Provided as the default driver on the in-box CD. This driver is automatically installed unless you select a different one.
- Recommended for all Windows environments
- Provides the overall best speed, print quality, and product-feature support for most users
- Developed to align with the Windows Graphic Device Interface (GDI) for the best speed in Windows environments
- Might not be fully compatible with third-party and custom software programs that are based on PCL 5

---

## HP UPD PS driver

- Recommended for printing with Adobe® software programs or with other highly graphics-intensive software programs
- Provides support for printing from postscript emulation needs, or for postscript flash font support

---

## HP UPD PCL 5

- Recommended for general office printing in Windows environments
- Compatible with previous PCL versions and older HP LaserJet products
- The best choice for printing from third-party or custom software programs
- The best choice when operating with mixed environments, which require the product to be set to PCL 5 (UNIX, Linux, mainframe)
- Designed for use in corporate Windows environments to provide a single driver for use with multiple product models
- Preferred when printing to multiple product models from a mobile Windows computer

---

## HP UPD PCL 6

- Recommended for printing in all Windows environments
  - Provides the overall best speed, print quality, and printer feature support for most users
  - Developed to align with Windows Graphic Device Interface (GDI) for best speed in Windows environments
  - Might not be fully compatible with third-party and custom software programs that are based on PCL 5
- 

## HP Universal Print Driver (UPD)

The HP Universal Print Driver (UPD) for Windows is a single print driver that gives you instant access to virtually any HP LaserJet product, from any location, without downloading separate drivers. It is built on



proven HP print driver technology and has been tested thoroughly and used with many software programs. It is a powerful solution that performs consistently over time.

The HP UPD communicates directly with each HP product, gathers configuration information, and then customizes the user interface to show the product's unique, available features. It automatically enables features that are available for the product, such as two-sided printing and stapling, so you do not need to enable them manually.

For more information, go to [www.hp.com/go/upd](http://www.hp.com/go/upd).

## UPD installation modes

---

Traditional mode	<ul style="list-style-type: none"><li>• To use this mode, download UPD from the Internet. Go to <a href="http://www.hp.com/go/upd">www.hp.com/go/upd</a>.</li><li>• Use this mode if you are installing the driver for a single computer.</li><li>• It operates with a specific product.</li><li>• If you use this mode, you must install UPD separately for each computer and for each product.</li></ul>
Dynamic mode	<ul style="list-style-type: none"><li>• To use this mode, download UPD from the Internet. Go to <a href="http://www.hp.com/go/upd">www.hp.com/go/upd</a>.</li><li>• Dynamic mode allows you to use a single driver installation, so you can discover and print to HP products in any location.</li><li>• Use this mode if you are installing UPD for a workgroup.</li></ul>

---

## Change print-job settings (Windows)

### Change the settings for all print jobs until the software program is closed

The steps can vary; this procedure is most common.

1. From the software program, select the **Print** option.
2. Select the product, and then click **Properties** or **Preferences**.

### Change the default settings for all print jobs

1. **Windows XP, Windows Server 2003, and Windows Server 2008 (using the default Start menu view):** Click **Start**, and then click **Printers and Faxes**.

**Windows XP, Windows Server 2003, and Windows Server 2008 (using the Classic Start menu view):** Click **Start**, click **Settings**, and then click **Printers**.

**Windows Vista:** Click the Windows icon in the lower-left corner of the screen, click **Control Panel**, and then click **Printers**.

**Windows 7:** Click the Windows icon in the lower-left corner of the screen, and then click **Devices and Printers**.

2. Right-click the print-driver icon, and then select **Printing Preferences**.

### Change the product configuration settings

1. **Windows XP, Windows Server 2003, and Windows Server 2008 (using the default Start menu view):** Click **Start**, and then click **Printers and Faxes**.

**Windows XP, Windows Server 2003, and Windows Server 2008 (using the Classic Start menu view):** Click **Start**, click **Settings**, and then click **Printers**.

**Windows Vista:** Click the Windows icon in the lower-left corner of the screen, click **Control Panel**, and then click **Printers**.

**Windows 7:** Click the Windows icon in the lower-left corner of the screen, and then click **Devices and Printers**.

2. Right-click the print-driver icon, and then select **Properties** or **Printer properties**.
3. Click the **Device Settings** tab.

# Change print-job settings (Mac OS X)

## Change the settings for all print jobs until the software program is closed

1. Click the **File** menu, and then click the **Print** option.
2. In the **Printer** menu, select the product.
3. By default, the print driver displays the **Copies & Pages** menu. Open the menus drop-down list, and then open a menu for which you want to change the print settings.
4. For each menu, select the print settings that you want to change.
5. Change the settings that you want on the various menus.

## Change the default settings for all print jobs

1. Click the **File** menu, and then click the **Print** option.
2. In the **Printer** menu, select the product.
3. By default, the print driver displays the **Copies & Pages** menu. Open the menus drop-down list, and then open a menu for which you want to change the print settings.
4. For each menu, select the print settings that you want to save for reuse.
5. In the **Presets** menu, click the **Save As...** option, and enter a name for the preset.
6. Click the **OK** button.

These settings are saved in the **Presets** menu. To use the new settings, you must select the saved preset option every time you open a program and print.

## Change the product configuration settings

1. At the computer, open the Apple  menu, click the **System Preferences** menu, and then click the **Print & Fax** icon (OS X v10.5 and 10.6) or the **Print & Scan** icon (OS X v10.7).
2. Select the product in the left side of the window.
3. Click the **Options & Supplies** button.
4. Click the **Driver** tab.
5. Configure the installed options.

# Print tasks (Windows)

## Use a printing shortcut (Windows)

1. From the software program, select the **Print** option.
2. Select the product, and then click the **Properties** or **Preferences** button.

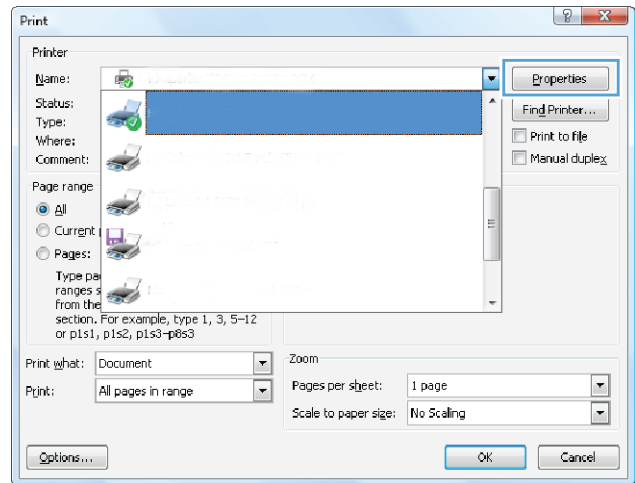

3. Click the **Printing Shortcuts** tab.

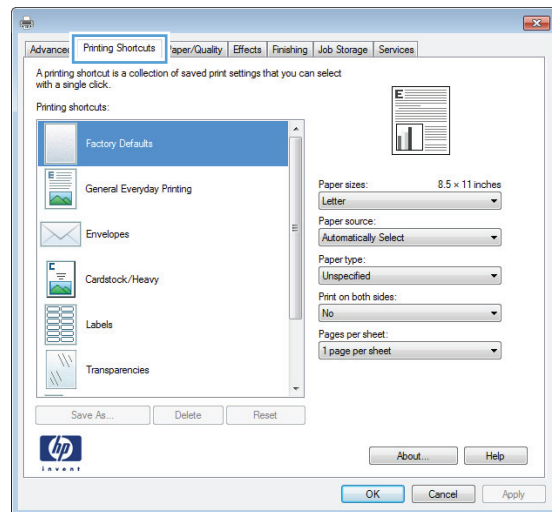

4. Select one of the shortcuts. Click the **OK** button to close the **Document Properties** dialog box.

**NOTE:** When you select a shortcut, the corresponding settings change on the other tabs in the print driver.

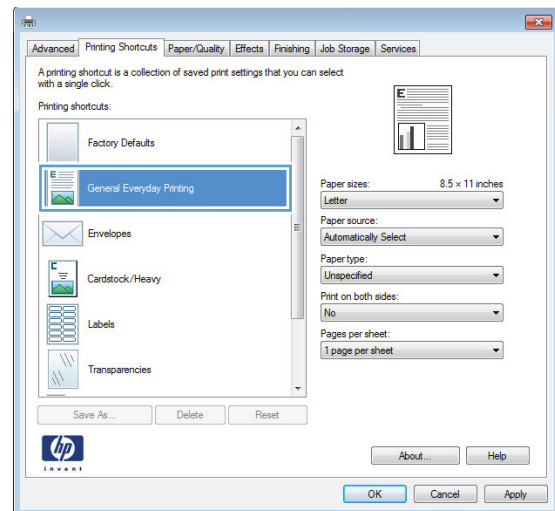

5. In the **Print** dialog box, click the **OK** button to print the job.

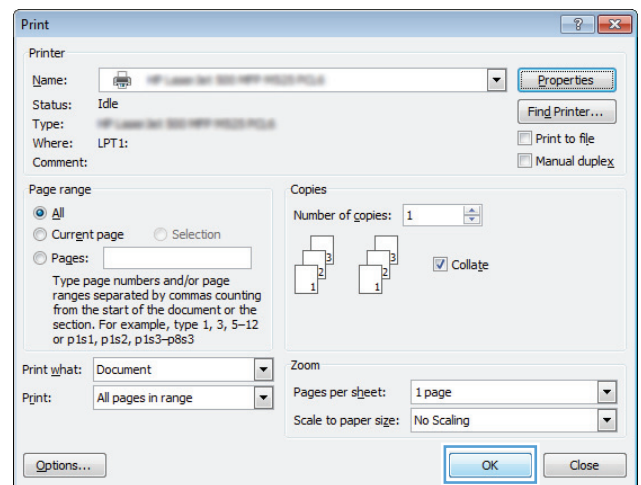

## Create printing shortcuts (Windows)

1. From the software program, select the **Print** option.
2. Select the product, and then click the **Properties** or **Preferences** button.

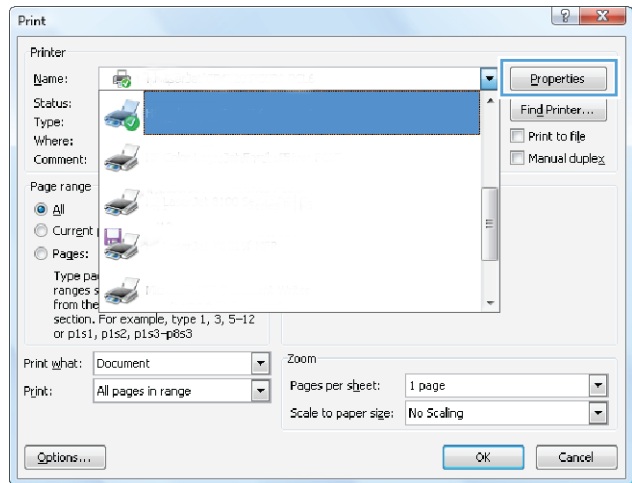

3. Click the **Printing Shortcuts** tab.

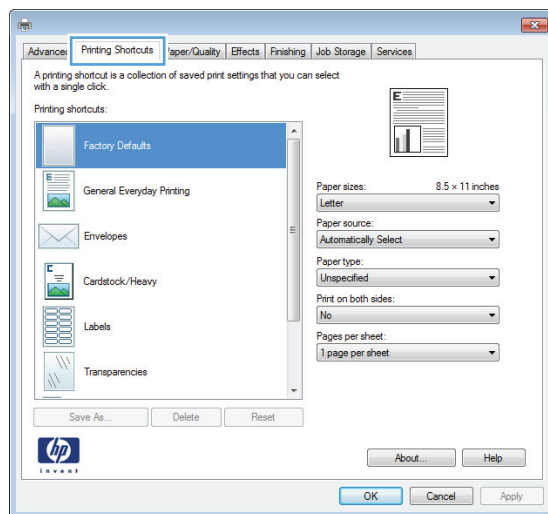

4. Select an existing shortcut as a base.

**NOTE:** Always select a shortcut before adjusting any of the settings on the right side of the screen. If you adjust the settings and then select a shortcut, all your adjustments are lost.

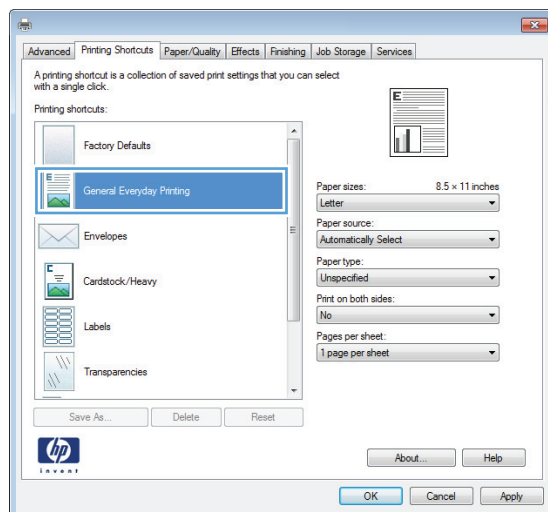

5. Select the print options for the new shortcut.

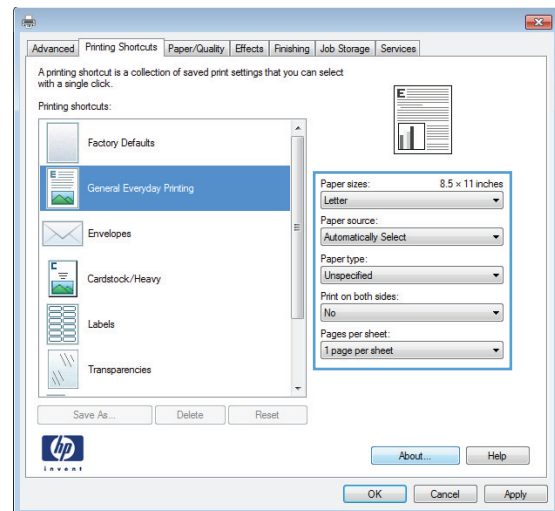

6. Click the **Save As** button.

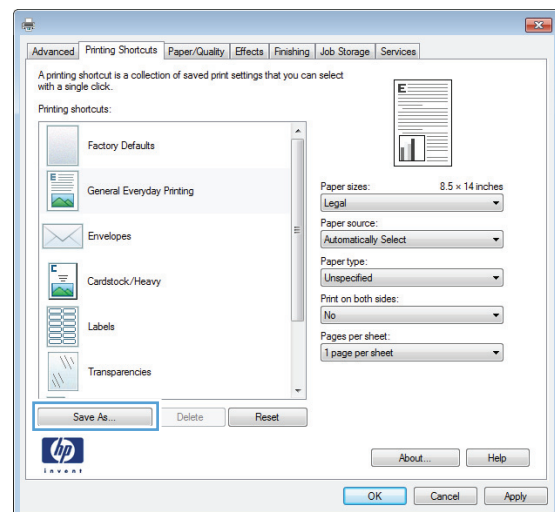

7. Enter a name for the shortcut, and then click the **OK** button.

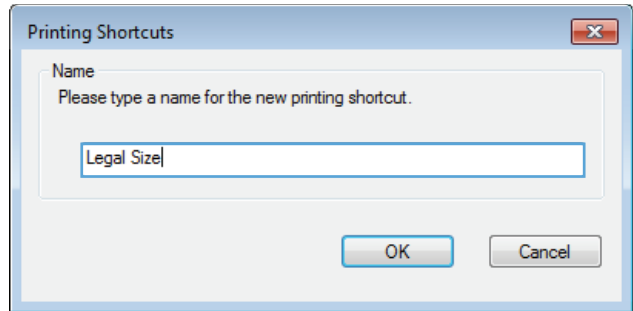

8. Click the **OK** button to close the **Document Properties** dialog box. In the **Print** dialog box, click the **OK** button to print the job.

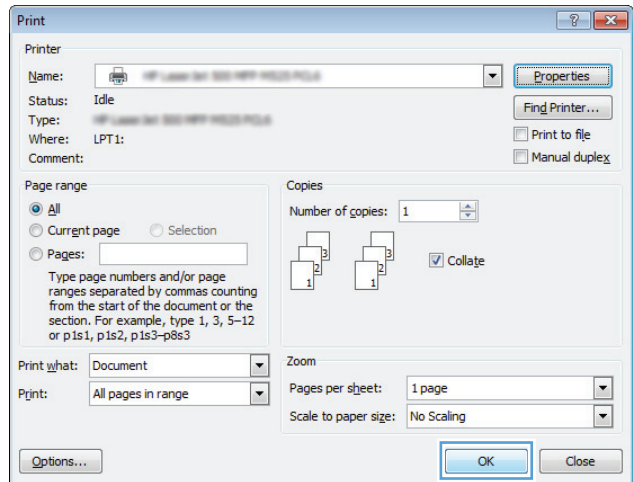



## Automatically print on both sides (Windows)

1. From the software program, select the **Print** option.
2. Select the product, and then click the **Properties** or **Preferences** button.

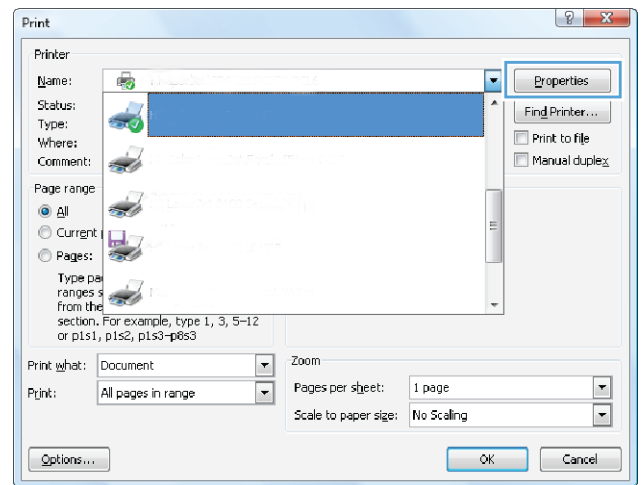

3. Click the **Finishing** tab.

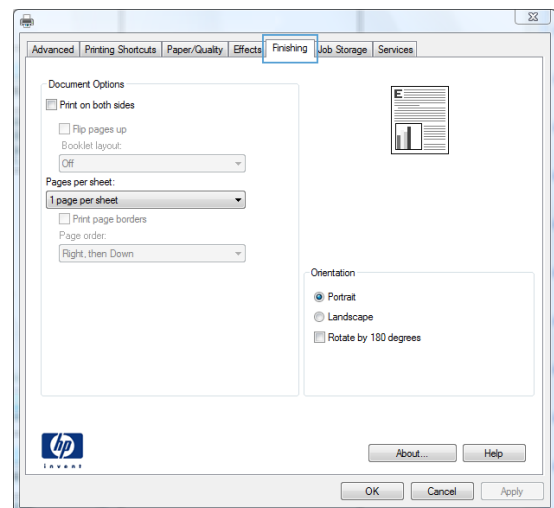

4. Select the **Print on both sides** check box. Click the **OK** button to close the **Document Properties** dialog box.

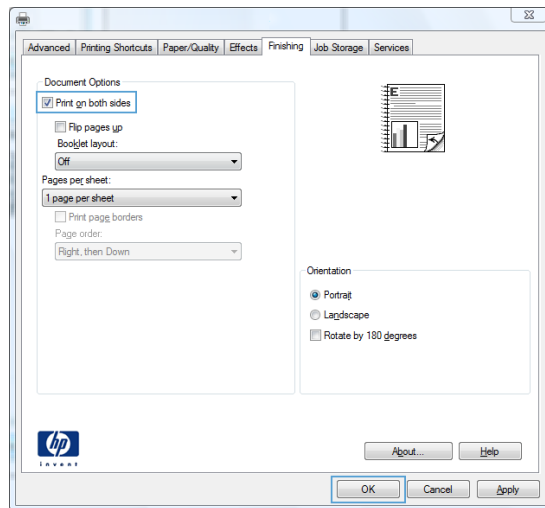

5. In the **Print** dialog box, click the **OK** button to print the job.

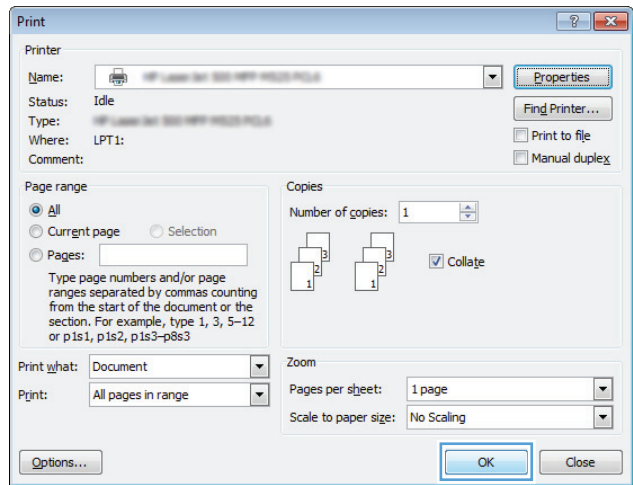

## Print multiple pages per sheet (Windows)

1. From the software program, select the **Print** option.
2. Select the product, and then click the **Properties** or **Preferences** button.

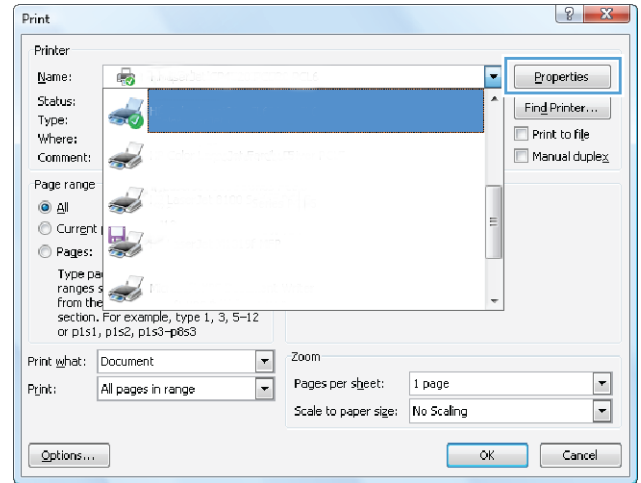

3. Click the **Finishing** tab.

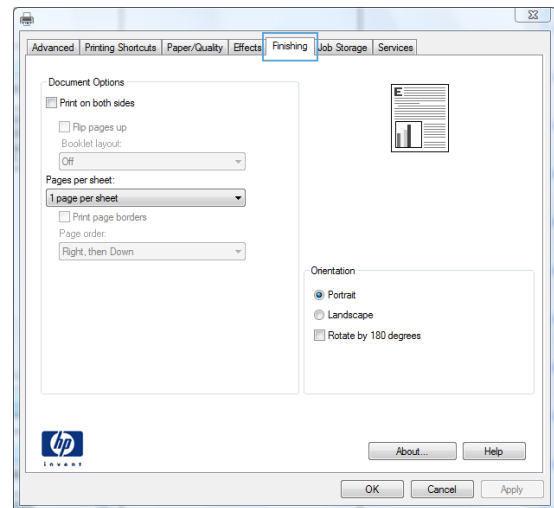

4. Select the number of pages per sheet from the **Pages per sheet** drop-down list.

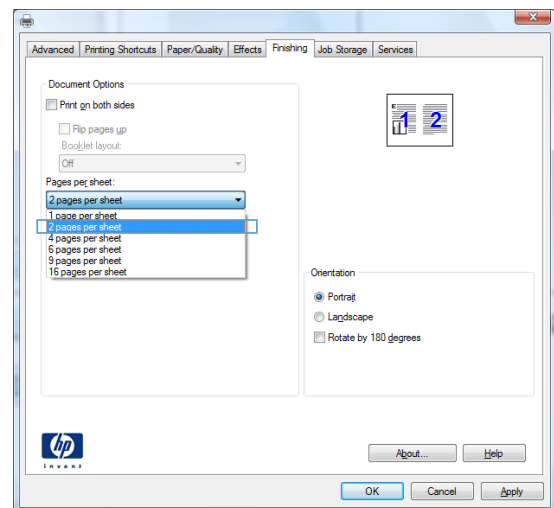

5. Select the correct **Print page borders**, **Page order**, and **Orientation** options. Click the **OK** button to close the **Document Properties** dialog box.

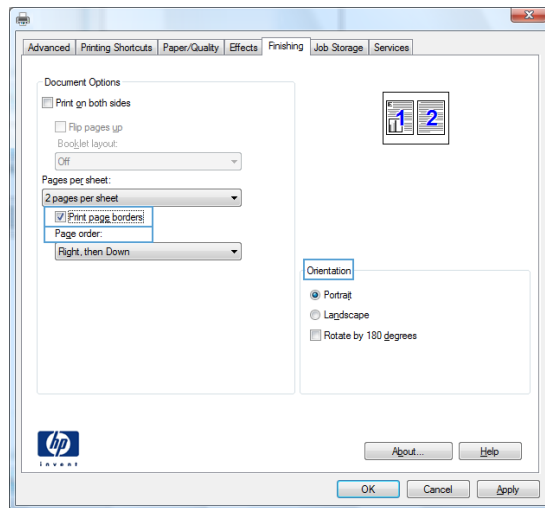

6. In the **Print** dialog box, click the **OK** button to print the job.

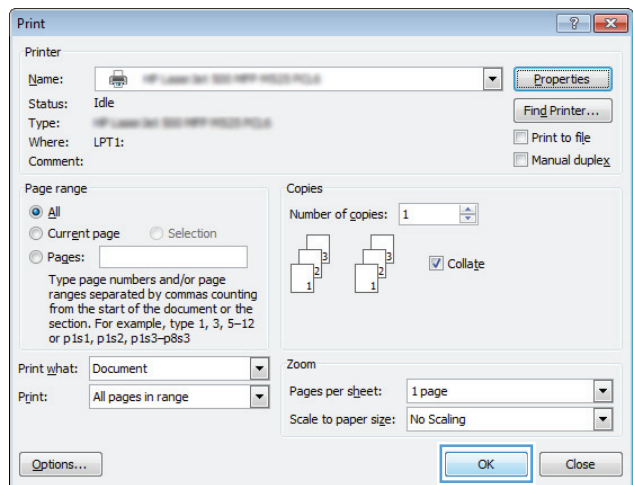

## Select the page orientation (Windows)

1. From the software program, select the **Print** option.
2. Select the product, and then click the **Properties** or **Preferences** button.

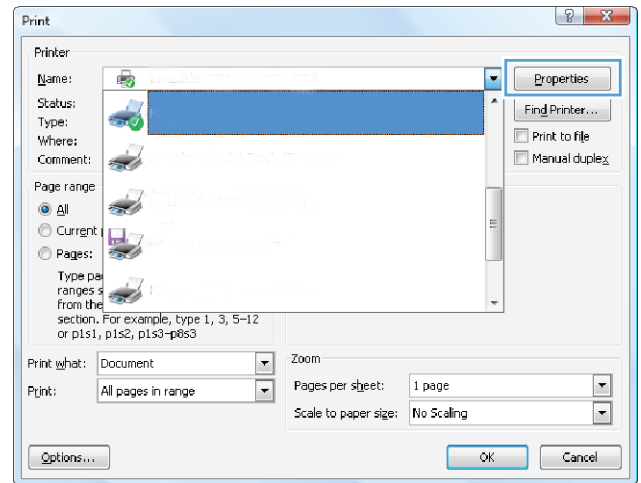

3. Click the **Finishing** tab.

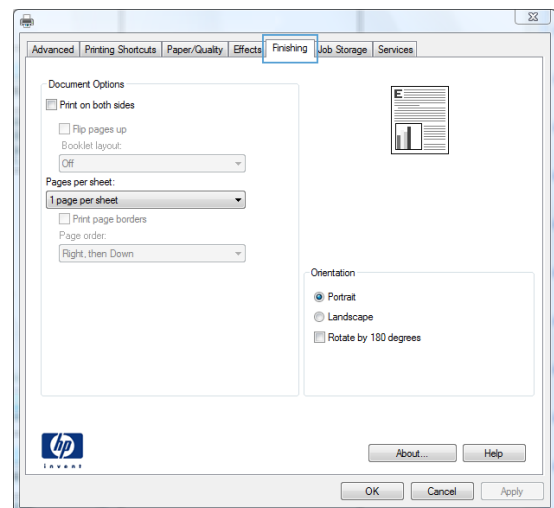

4. In the **Orientation** area, select the **Portrait** or **Landscape** option.

To print the page image upside down, select the **Rotate by 180 degrees** option.

Click the **OK** button to close the **Document Properties** dialog box.

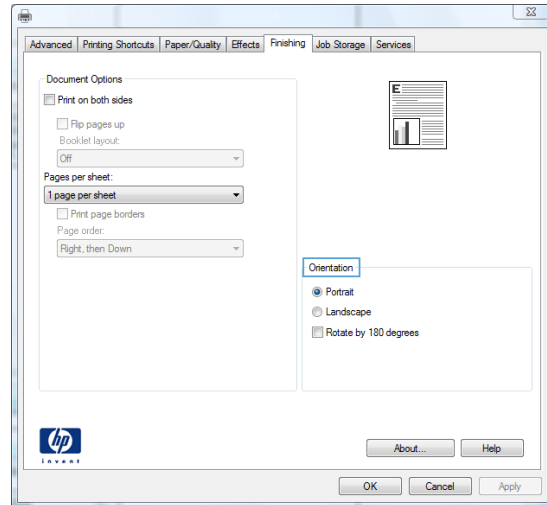

5. In the **Print** dialog box, click the **OK** button to print the job.

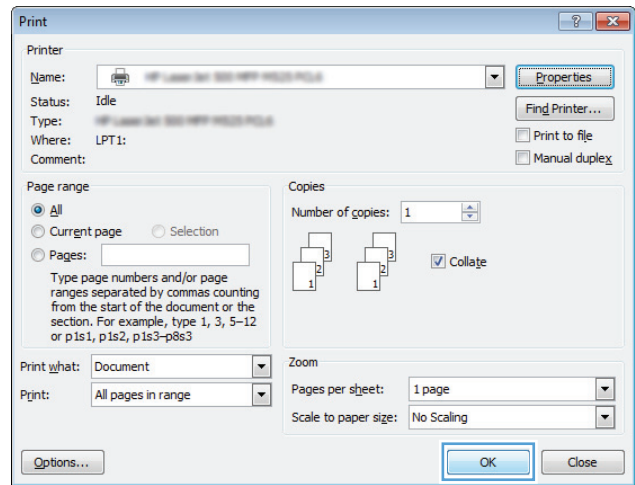

## Select the paper type (Windows)

1. From the software program, select the **Print** option.
2. Select the product, and then click the **Properties** or **Preferences** button.

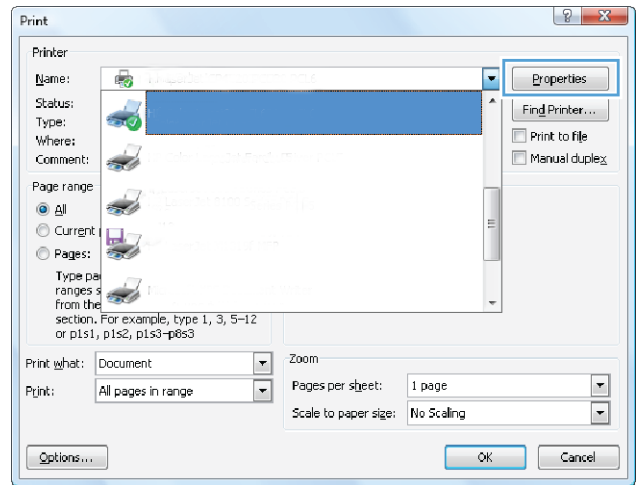

3. Click the **Paper/Quality** tab.

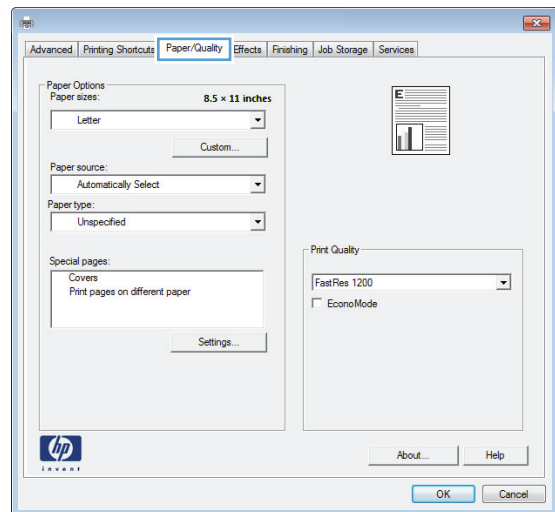

4. From the **Paper type** drop-down list, click the **More...** option.

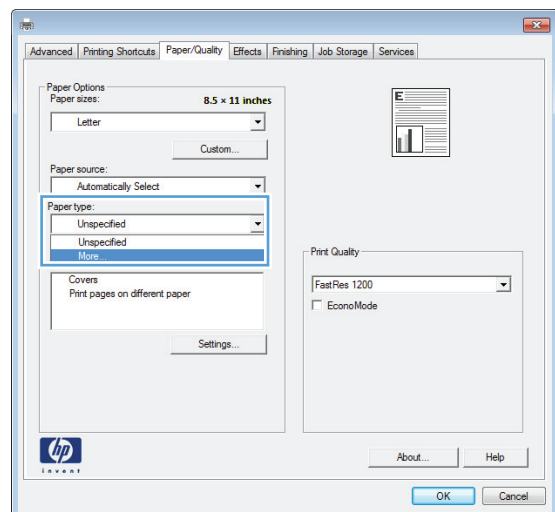

5. Expand the list of **Type is:** options.

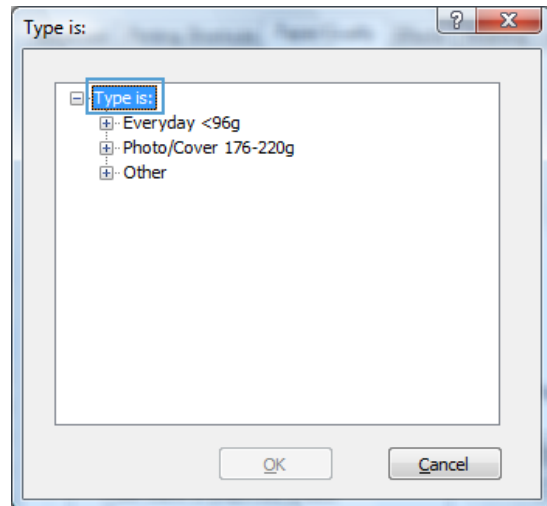

6. Expand the category of paper types that best describes your paper.

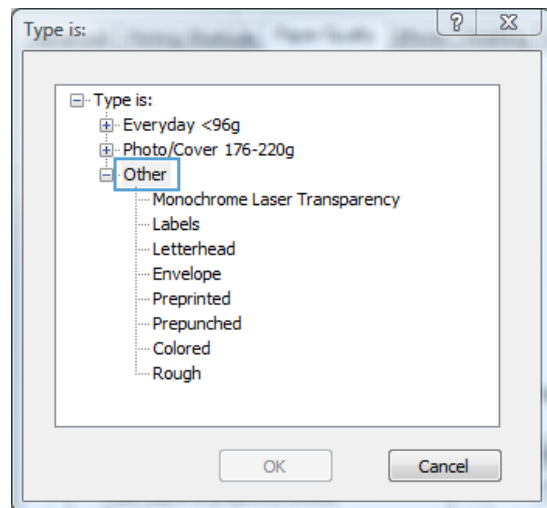



7. Select the option for the type of paper you are using, and click the **OK** button.

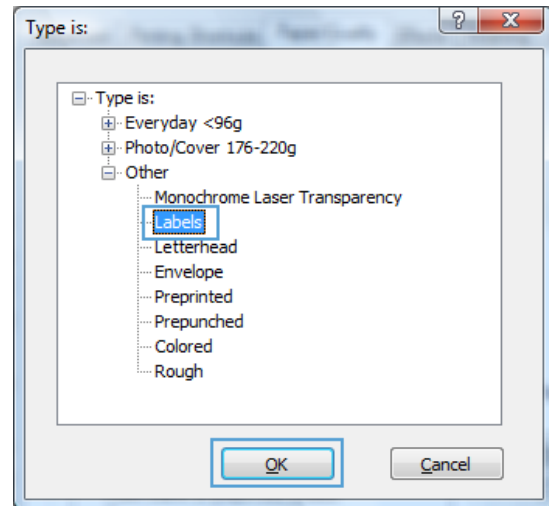

8. Click the **OK** button to close the **Document Properties** dialog box. In the **Print** dialog box, click the **OK** button to print the job.

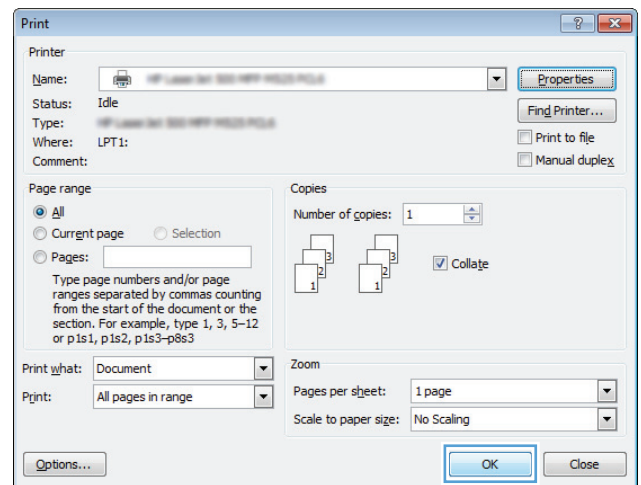

## Print the first or last page on different paper (Windows)

1. From the software program, select the **Print** option.
2. Select the product, and then click the **Properties** or **Preferences** button.

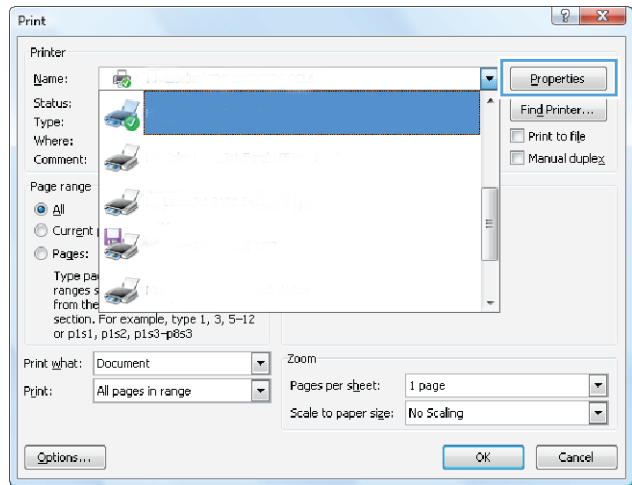

3. Click the **Paper/Quality** tab.

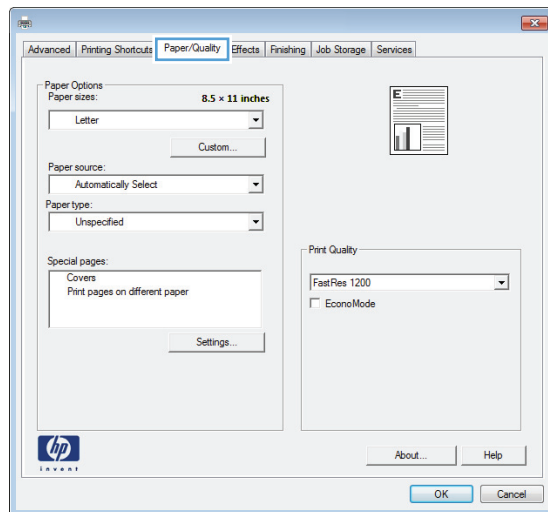

4. In the **Special pages** area, click the **Print pages on different paper** option, and then click the **Settings** button.

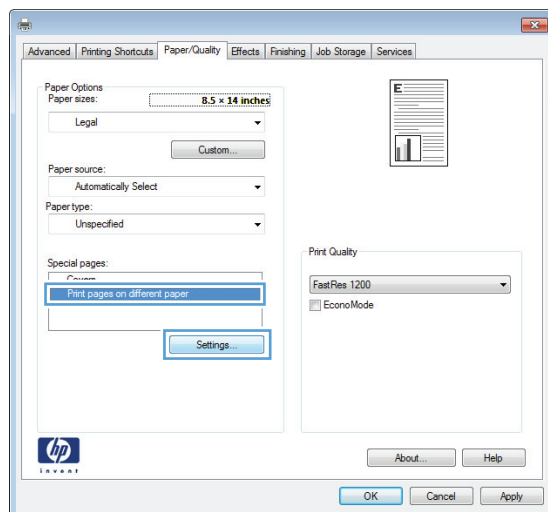

- In the **Pages in document** area, select either the **First** or **Last** option.

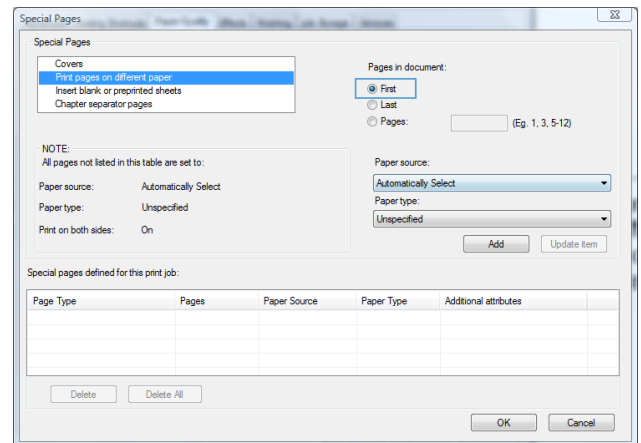

- Select the correct options from the **Paper source** and **Paper type** drop-down lists. Click the **Add** button.

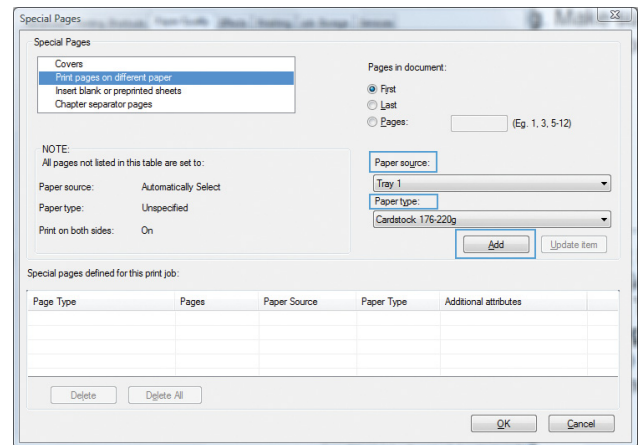

- If you are printing *both* the first and last pages on different paper, repeat steps 5 and 6, selecting the options for the other page.

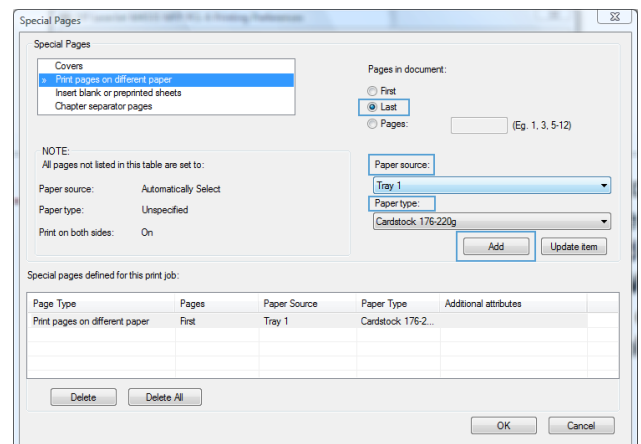

8. Click the **OK** button.

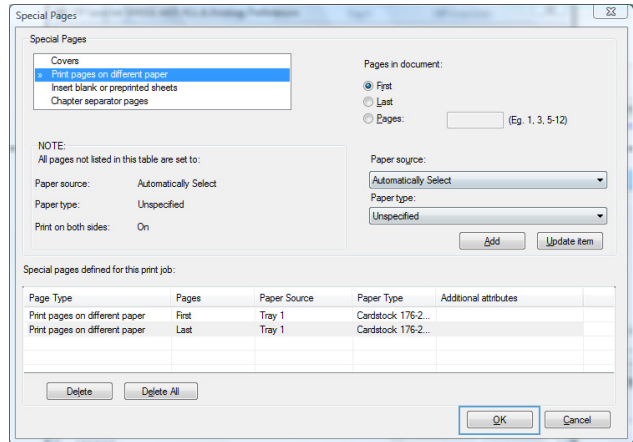

9. Click the **OK** button to close the **Document Properties** dialog box. In the **Print** dialog box, click the **OK** button to print the job.

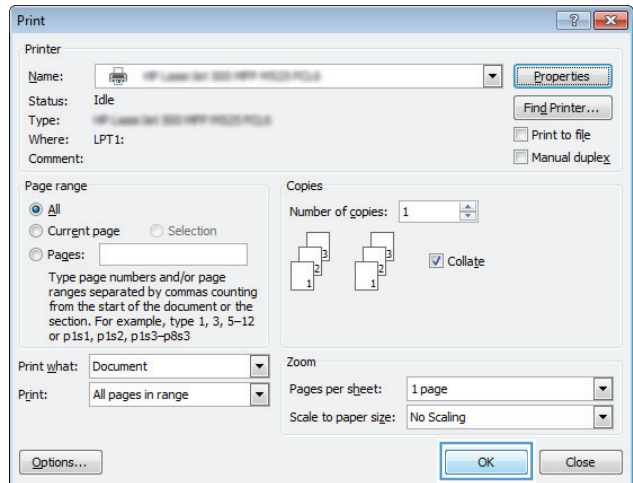

## Scale a document to fit page size (Windows)

1. From the software program, select the **Print** option.
2. Select the product, and then click the **Properties** or **Preferences** button.

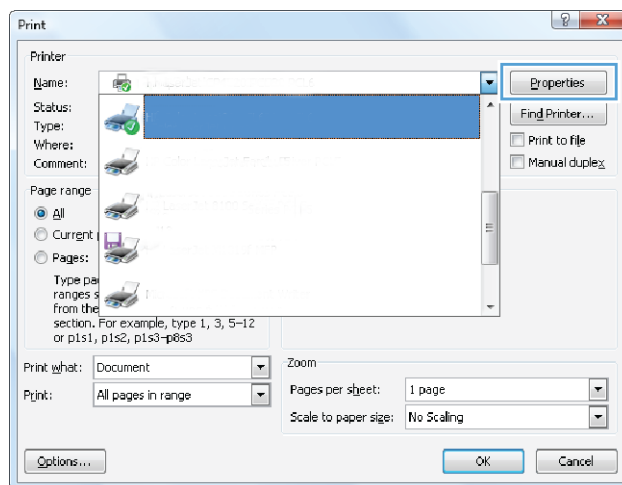

3. Click the **Effects** tab.

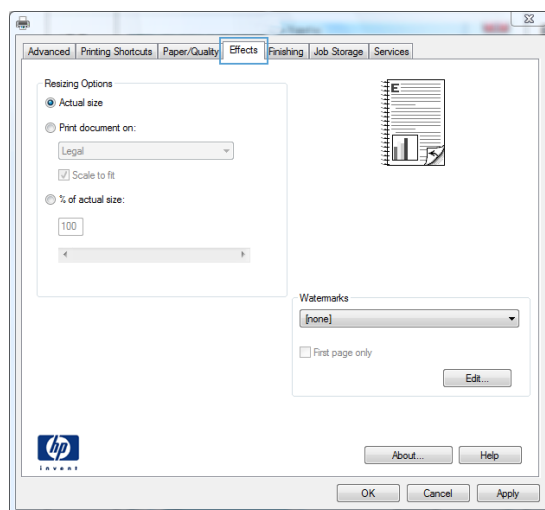

4. Select the **Print document on** option, and then select a size from the drop-down list.

Click the **OK** button to close the **Document Properties** dialog box.

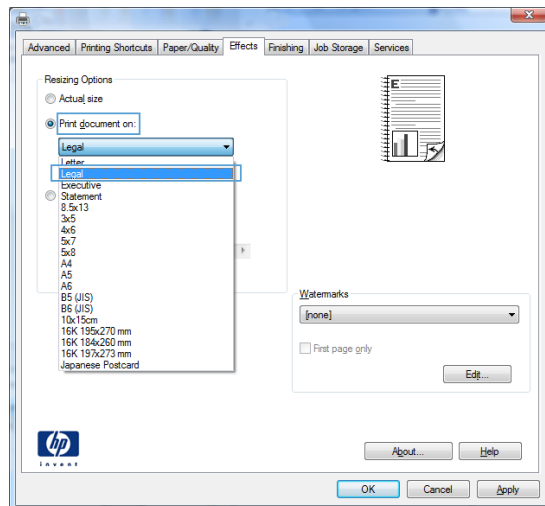

5. In the **Print** dialog box, click the **OK** button to print the job.

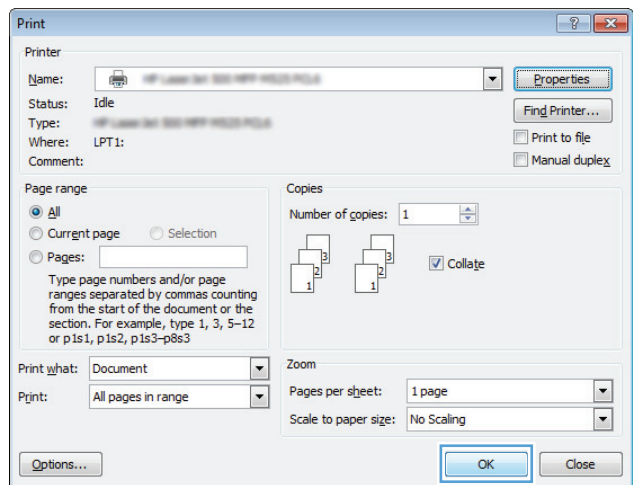

## Create a booklet (Windows)

1. From the software program, select the **Print** option.
2. Select the product, and then click the **Properties** or **Preferences** button.

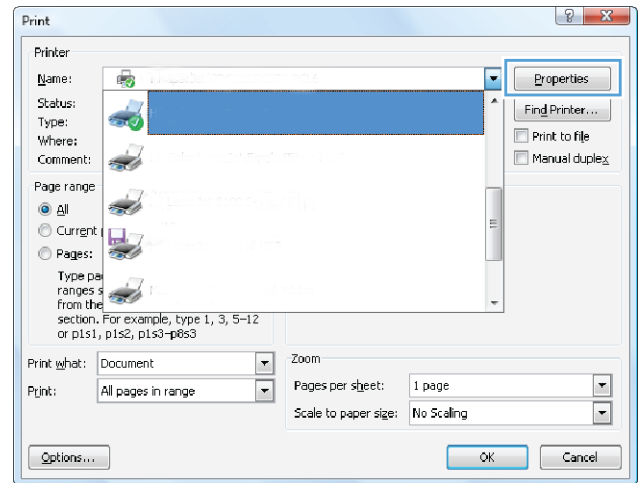

3. Click the **Finishing** tab.

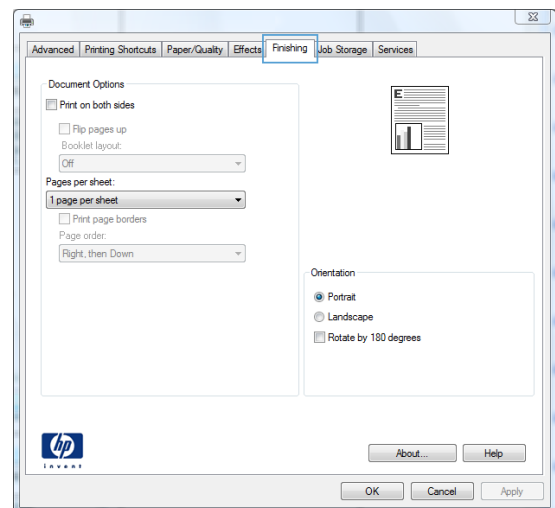

4. Select the **Print on both sides** check box.

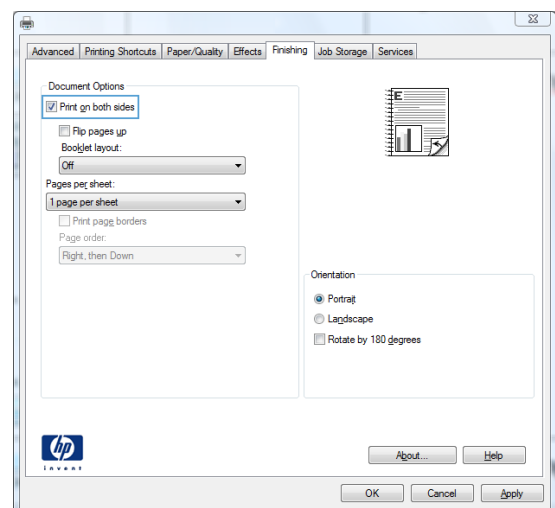

5. In the **Booklet layout** drop-down list, click the **Left binding** or **Right binding** option. The **Pages per sheet** option automatically changes to **2 pages per sheet**.

Click the **OK** button to close the **Document Properties** dialog box.

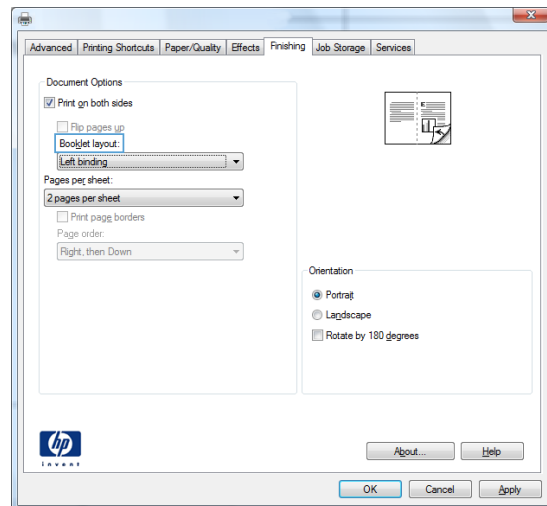

6. In the **Print** dialog box, click the **OK** button to print the job.

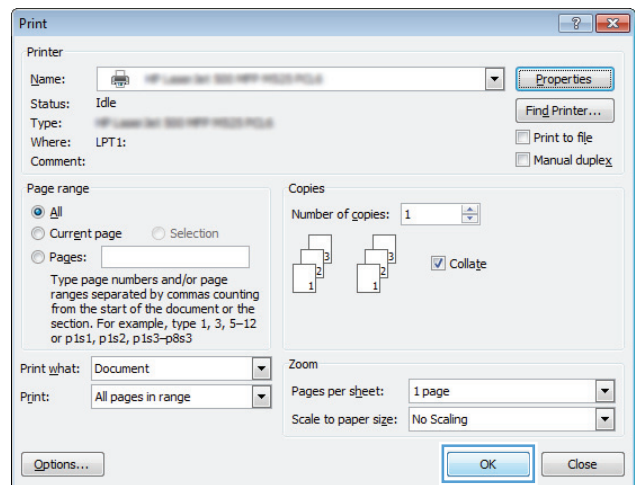



# Print tasks (Mac OS X)

## Use a printing preset (Mac OS X)

1. Click the **File** menu, and then click the **Print** option.
2. In the **Printer** menu, select the product.
3. In the **Presets** menu, select the printing preset.
4. Click the **Print** button.



**NOTE:** To use print-driver default settings, select the **standard** option.

## Create a printing preset (Mac OS X)

Use printing presets to save the current print settings for reuse.

1. Click the **File** menu, and then click the **Print** option.
2. In the **Printer** menu, select the product.
3. By default, the print driver displays the **Copies & Pages** menu. Open the menus drop-down list, and then open a menu for which you want to change the print settings.
4. For each menu, select the print settings that you want to save for reuse.
5. In the **Presets** menu, click the **Save As...** option, and enter a name for the preset.
6. Click the **OK** button.

## Automatically print on both sides (Mac OS X)

1. Click the **File** menu, and then click the **Print** option.
2. In the **Printer** menu, select the product.
3. By default, the print driver displays the **Copies & Pages** menu. Open the menus drop-down list, and then click the **Layout** menu.
4. Select a binding option from the **Two-Sided** drop-down list.
5. Click the **Print** button.

## Print multiple pages per sheet (Mac OS X)

1. Click the **File** menu, and then click the **Print** option.
2. In the **Printer** menu, select the product.
3. By default, the print driver displays the **Copies & Pages** menu. Open the menus drop-down list, and then click the **Layout** menu.

4. From the **Pages per Sheet** drop-down list, select the number of pages that you want to print on each sheet.
5. In the **Layout Direction** area, select the order and placement of the pages on the sheet.
6. From the **Border** menu, select the type of border to print around each page on the sheet.
7. Click the **Print** button.

## Select the page orientation (Mac OS X)

1. Click the **File** menu, and then click the **Print** option.
2. In the **Printer** menu, select the product.
3. In the **Copies & Pages** menu, click the **Page Setup** button.
4. Click the icon that represents the page orientation that you want to use, and then click the **OK** button.
5. Click the **Print** button.

## Select the paper type (Mac OS X)

1. Click the **File** menu, and then click the **Print** option.
2. In the **Printer** menu, select the product.
3. By default, the print driver displays the **Copies & Pages** menu. Open the menu's drop-down list, and then click the **Finishing** menu.
4. Select a type from the **Media Type** drop-down list.
5. Click the **Print** button.

## Print a cover page (Mac OS X)

1. Click the **File** menu, and then click the **Print** option.
2. In the **Printer** menu, select the product.
3. By default, the print driver displays the **Copies & Pages** menu. Open the menu's drop-down list, and then click the **Cover Page** menu.
4. Select where to print the cover page. Click either the **Before Document** button or the **After Document** button.
5. In the **Cover Page Type** menu, select the message that you want to print on the cover page.



**NOTE:** To print a blank cover page, select the **standard** option from the **Cover Page Type** menu.

6. Click the **Print** button.

## Scale a document to fit page size (Mac OS X)

1. Click the **File** menu, and then click the **Print** option.
2. In the **Printer** menu, select the product.
3. By default, the print driver displays the **Copies & Pages** menu. Open the menus drop-down list, and then click the **Paper Handling** menu.
4. In the **Destination Paper Size** area, click the **Scale to fit paper size** box, and then select the size from the drop-down list.
5. Click the **Print** button.

## Create a booklet (Mac OS X)

1. Click the **File** menu, and then click the **Print** option.
2. In the **Printer** menu, select the product.
3. By default, the print driver displays the **Copies & Pages** menu. Open the menus drop-down list, and then click the **Layout** menu.
4. Select a binding option from the **Two-Sided** drop-down list.
5. Open the menus drop-down list, and then click the **Booklet Printing** menu.
6. Click the **Format Output As Booklet** box, and select a binding option.
7. Select the paper size.
8. Click the **Print** button.

# Additional print tasks (Windows)

## Cancel a print job (Windows)

 **NOTE:** If the print job is too far into the printing process, you might not have the option to cancel it.

1. If the print job is currently printing, cancel it from the product control panel by following this procedure:
  - a. From the Home screen on the product control panel, touch the Stop  button. The product pauses the job, and the [Job Status](#) screen opens.
  - b. From the list on the touchscreen, touch the print job you want to cancel, and then touch the [Cancel Job](#) button.
  - c. The product prompts you to confirm the cancellation. Touch the [Yes](#) button.
2. You can also cancel a print job from a software program or a print queue.
  - **Software program:** Typically, a dialog box appears briefly on the computer screen, allowing you to cancel the print job.
  - **Windows print queue:** If a print job is waiting in a print queue (computer memory) or print spooler, delete the job there.
    - **Windows XP, Server 2003, or Server 2008:** Click **Start**, click **Settings**, and then click **Printers and Faxes**. Double-click the product icon to open the window, right-click the print job that you want to cancel, and then click **Cancel**.
    - **Windows Vista:** Click the Windows icon in the lower left corner of the screen, click **Settings**, and then click **Printers**. Double-click the product icon to open the window, right-click the print job that you want to cancel, and then click **Cancel**.
    - **Windows 7:** Click the Windows icon in the lower left corner of the screen, and then click **Devices and Printers**. Double-click the product icon to open the window, right-click the print job that you want to cancel, and then click **Cancel**.

## Select the paper size (Windows)

1. From the software program, select the **Print** option.
2. Select the product, and then click the **Properties** or **Preferences** button.
3. Click the **Paper/Quality** tab.
4. Select a size from the **Paper size** drop-down list.
5. Click the **OK** button.
6. In the **Print** dialog box, click the **OK** button to print the job.

## Select a custom paper size (Windows)

1. From the software program, select the **Print** option.
2. Select the product, and then click the **Properties** or **Preferences** button.
3. Click the **Paper/Quality** tab.
4. Click the **Custom** button.
5. Type a name for the custom size and specify the dimensions.
  - The width is the short edge of the paper.
  - The length is the long edge of the paper.
6. Click the **Save** button, and then click the **Close** button.
7. Click the **OK** button to close the **Document Properties** dialog box. In the **Print** dialog box, click the **OK** button to print the job.

## Print watermarks (Windows)

1. From the software program, select the **Print** option.
2. Select the product, and then click the **Properties** or **Preferences** button.
3. Click the **Effects** tab.
4. Select a watermark from the **Watermarks** drop-down list.

Or, to add a new watermark to the list, click the **Edit** button. Specify the settings for the watermark, and then click the **OK** button.
5. To print the watermark on the first page only, select the **First page only** check box. Otherwise, the watermark is printed on each page.
6. Click the **OK** button to close the **Document Properties** dialog box. In the **Print** dialog box, click the **OK** button to print the job.

# Additional print tasks (Mac OS X)

## Cancel a print job (Mac OS X)



**NOTE:** If the print job is too far into the printing process, you might not have the option to cancel it.

1. If the print job is currently printing, cancel it from the product control panel by following this procedure:
  - a. From the Home screen on the product control panel, touch the Stop  button. The product pauses the job, and the [Job Status](#) screen opens.
  - b. From the list on the touchscreen, touch the print job you want to cancel, and then touch the [Cancel Job](#) button.
  - c. The product prompts you to confirm the cancellation. Touch the [Yes](#) button.
2. You can also cancel a print job from a software program or a print queue.
  - **Software program:** Typically, a dialog box appears briefly on the computer screen, allowing you to cancel the print job.
  - **Mac print queue:** Open the print queue by double-clicking the product icon in the dock. Highlight the print job, and then click **Delete**.

## Select the paper size (Mac OS X)

1. Click the **File** menu, and then click the **Print** option.
2. In the **Printer** menu, select the product.
3. In the **Copies & Pages** menu, click the **Page Setup** button.
4. Select a size from the **Paper Size** drop-down list, and then click the **OK** button.
5. Click the **Print** button.

## Select a custom paper size (Mac OS X)

1. Click the **File** menu, and then click the **Print** option.
2. In the **Printer** menu, select the product.
3. In the **Copies & Pages** menu, click the **Page Setup** button.
4. From the **Paper Size** drop-down list, select the **Manage Custom Sizes** option.
5. Specify the dimensions for the page size, and then click the **OK** button.
6. Click the **OK** button to close the **Page Setup** dialog.
7. Click the **Print** button.

## Print watermarks (Mac OS X)

1. Click the **File** menu, and then click the **Print** option.
2. In the **Printer** menu, select the product.
3. By default, the print driver displays the **Copies & Pages** menu. Open the menus drop-down list, and then click the **Watermarks** menu.
4. From the **Mode** menu, select the **Watermark** option.
5. From the **Pages** drop-down list, select whether to print the watermark on all pages or on the first page only.
6. From the **Text** drop-down list, select one of the standard messages, or select the **Custom** option and type a new message in the box.
7. Select options for the remaining settings.
8. Click the **Print** button.

# Store print jobs on the product

## Create a stored job (Windows)

You can store jobs on the product so you can print them at any time.

1. From the software program, select the **Print** option.
2. Select the product, and then click the **Properties** or **Preferences** button.

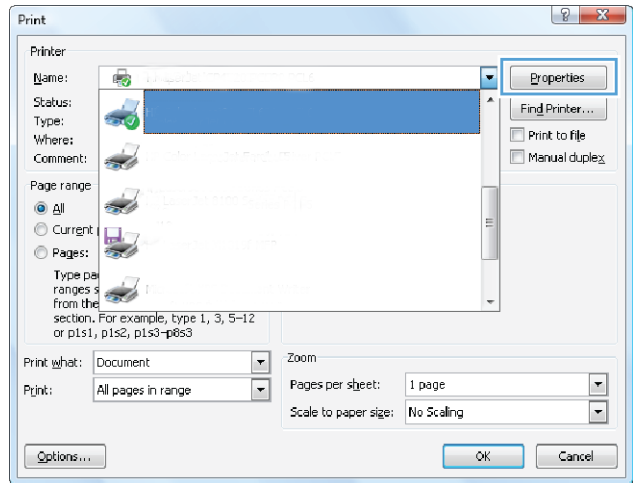

3. Click the **Job Storage** tab.

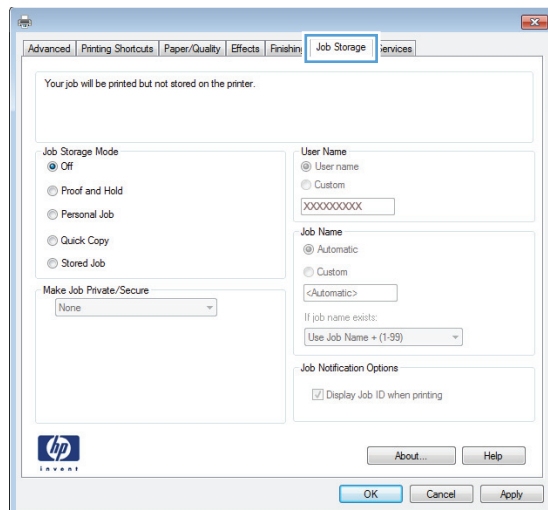



#### 4. Select a **Job Storage Mode** option.

- **Proof and Hold:** Print and proof one copy of a job and then print more copies.
- **Personal Job:** The job does not print until you request it at the product control panel. For this job-storage mode, you can select one of the **Make Job Private/Secure** options. If you assign a personal identification number (PIN) to the job, you must provide the required PIN at the control panel. If you encrypt the job, you must provide the required password at the control panel.
- **Quick Copy:** Print the requested number of copies of a job and then store a copy of the job in the product memory so you can print it again later.
- **Stored Job:** Store a job on the product and allow other users to print the job at any time. For this job-storage mode, you can select one of the **Make Job Private/Secure** options. If you assign a personal identification number (PIN) to the job, the person who prints the job must provide the required PIN at the control panel. If you encrypt the job, the person who prints the job must provide the required password at the control panel.

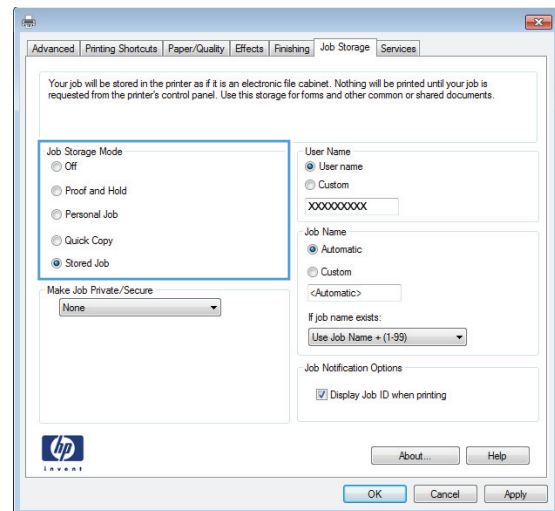

- To use a custom user name or job name, click the **Custom** button, and then enter the user name or the job name.

Select which option to use if another stored job already has that name:

- **Use Job Name + (1-99)**: Append a unique number to the end of the job name.
- **Replace Existing File**: Overwrite the existing stored job with the new one.

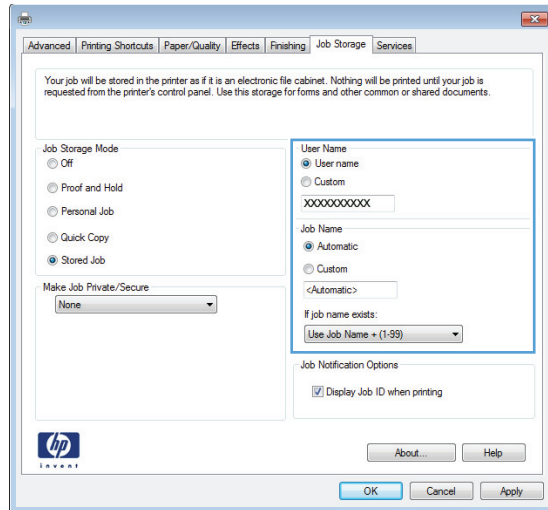

- Click the **OK** button to close the **Document Properties** dialog box. In the **Print** dialog box, click the **OK** button to print the job.

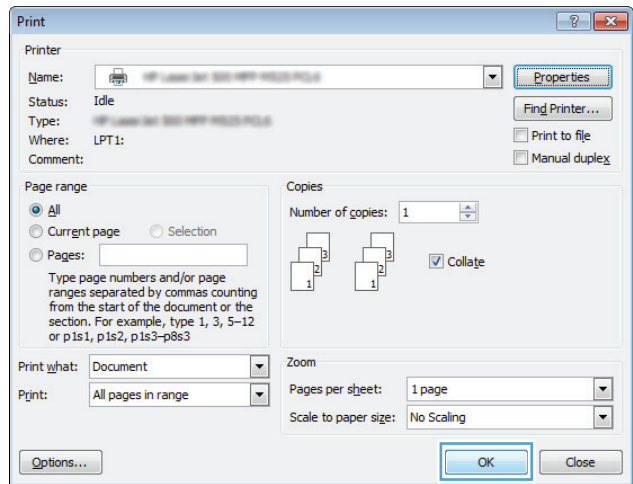

## Create a stored job (Mac OS X)

You can store jobs on the product so you can print them at any time.

- Click the **File** menu, and then click the **Print** option.
- In the **Printer** menu, select the product.
- By default, the print driver displays the **Copies & Pages** menu. Open the menu's drop-down list, and then click the **Job Storage** menu.
- In the **Mode** drop-down list, select the type of stored job.
  - **Proof and Hold**: Print and proof one copy of a job and then print more copies.
  - **Personal Job**: The job does not print until you request it at the product control panel. If you assign a personal identification number (PIN) to the job, you must provide the required PIN at the control panel.

- **Quick Copy:** Print the requested number of copies of a job and then store a copy of the job in the product memory so you can print it again later.
  - **Stored Job:** Store a job on the product and allow other users to print the job at any time. If you assign a personal identification number (PIN) to the job, the person who prints the job must provide the required PIN at the control panel.
5. To use a custom user name or job name, click the **Custom** button, and then enter the user name or the job name.

Select which option to use if another stored job already has that name.

<b>Use Job Name + (1 - 99)</b>	Append a unique number to the end of the job name.
<b>Replace Existing File</b>	Overwrite the existing stored job with the new one.

6. If you selected the **Stored Job** or **Personal Job** option in step 3, you can protect the job with a PIN. Type a 4-digit number in the **Use PIN to Print** field. When other people attempt to print this job, the product prompts them to enter this PIN number.
7. Click the **Print** button to process the job.

## Print a stored job

Use the following procedure to print a job that is stored in the product memory.

1. From the Home screen on the product control panel, scroll to and touch the [Retrieve from Device Memory](#) button.
2. Select the name of the folder where the job is stored.
3. Select the name of the job. If the job is private or encrypted, enter the PIN or password.
4. Adjust the number of copies, and then touch the Start  button to print the job.

## Delete a stored job

When you send a stored job to the product memory, the product overwrites any previous jobs with the same user and job name. If a job is not already stored under the same user and job name, and the product needs additional space, the product might delete other stored jobs starting with the oldest. You can change the number of jobs that the product can store from the [General Settings](#) menu on the product control panel.

Use this procedure to delete a job that is stored in the product memory.

1. From the Home screen on the product control panel, scroll to and touch the [Retrieve from Device Memory](#) button.
2. Select the name of the folder where the job is stored.
3. Select the name of the job, and then touch the [Delete](#) button.
4. If the job is private or encrypted, enter the PIN or the password, and then touch the [Delete](#) button.

## Add a job-separator page (Windows)

The product can insert a blank page at the beginning of each print job to make sorting jobs easier.



**NOTE:** The following procedure turns on this setting for all print jobs.

- 1. Windows XP, Windows Server 2003, and Windows Server 2008 (using the default Start menu view):** Click **Start**, and then click **Printers and Faxes**.

**Windows XP, Windows Server 2003, and Windows Server 2008 (using the Classic Start menu view):** Click **Start**, click **Settings**, and then click **Printers**.

**Windows Vista:** Click the Windows icon in the lower-left corner of the screen, click **Control Panel**, and then click **Printers**.

**Windows 7:** Click the Windows icon in the lower-left corner of the screen, and then click **Devices and Printers**.

- 2.** Right-click the driver icon, and then select **Properties** or **Printer properties**.
- 3.** Click the **Device Settings** tab.
- 4.** Expand the **Installable Options** list.
- 5.** In the **Job Separator** drop-down list, select the **Enabled** option.
- 6.** Click the **OK** button.

# Use HP ePrint

Use HP ePrint to print documents by sending them as an email attachment to the product's email address from any email enabled device.

---

 **NOTE:** The product must be connected to a network and have Internet access to use HP ePrint.

---

1. To use HP ePrint, you must first enable HP Web Services.
  - a. Type the product IP address into the address line of a Web browser to open the HP Embedded Web Server.
  - b. Click the **HP Web Services** tab.
  - c. Select the option to enable Web Services.

---

 **NOTE:** Enabling Web Services might take several minutes.

---

2. Use the HP ePrintCenter Web site to define security settings and to configure default print settings for all HP ePrint jobs sent to this product.
  - a. Go to [www.hpeprintcenter.com](http://www.hpeprintcenter.com).
  - b. Click **Sign In**, and enter your HP ePrintCenter credentials or sign up for a new account.
  - c. Select your product from the list, or click **+ Add printer** to add it. To add the product, you need the printer code, which is the segment of the product email address that is before the @ symbol.

---

 **NOTE:** This code is valid for only 24 hours from the time you enable HP Web Services. If it expires, follow the instructions to enable HP Web Services again, and obtain a new code.

---
  - d. To prevent your product from printing unexpected documents, click **ePrint Settings**, and then click the **Allowed Senders** tab. Click **Allowed Senders Only**, and add the email addresses from which you want to allow ePrint jobs.
  - e. To set up default settings for all ePrint jobs sent to this product, click **ePrint Settings**, click **Print Options**, and select the settings that you want to use.
3. To print a document, attach it to an email message sent to the product's email address.

# Use the HP ePrint Mobile Driver

The HP ePrint Mobile Driver makes it easy to print from a desktop or laptop computer to any HP ePrint-capable product. After installing the driver, open the **Print** option from within your application, and then select **HP ePrint Mobile** from the installed printers list. This single driver makes it easy to find HP ePrint-enabled products that are registered to your ePrintCenter account. The target HP product can be at your desk or in a remote location, such as a branch office or across the globe—you can do remote printing by using the Internet without file type or size limitations. The target product can be anywhere in the world; if it is Web-connected and registered in ePrintCenter, you can send a print job to the product.

For Windows, the HP ePrint Mobile Driver also supports traditional direct IP printing to local network printers on the network (LAN or WAN) to supported PostScript® products.

Go to [www.hp.com/go/eprintmobiledriver](http://www.hp.com/go/eprintmobiledriver) for drivers and information.

## Supported operating systems

- Windows® XP (32-bit, SP 2 or greater)

---

 **NOTE:** Microsoft retired mainstream support for Windows XP in April 2009. HP will continue to provide best-effort support for the discontinued XP operating system.

---

- Windows Vista® (32-bit and 64-bit)
- Windows 7 (32-bit and 64-bit)
- Windows .Net 3.5 SP1

---

 **NOTE:** Windows .Net 3.5 is installed if you are not using the Add Printer wizard.

---

- Mac OS X v10.5 and v10.6

---

 **NOTE:** The HP ePrint Mobile Driver is a PDF workflow utility for Mac, and is not technically a print driver. HP ePrint Mobile for Mac supports print paths only through ePrintcenter and does not support direct IP printing to local network printers.

---

## Use Apple AirPrint

Direct printing using Apple's AirPrint is supported for iOS 4.2 or later. Use AirPrint to print wirelessly to the product from an iPad (iOS 4.2), iPhone (3GS or later), or iPod touch (third generation or later) in the following applications:

- Mail
- Photos
- Safari
- Select third-party applications

To use AirPrint, the product must be connected to a network. For more information about using AirPrint and about which HP products are compatible with AirPrint, go to [www.hp.com/go/airprint](http://www.hp.com/go/airprint).



**NOTE:** You might need to upgrade the product firmware to use AirPrint. Go to [www.hp.com/go/lj500MFP525\\_firmware](http://www.hp.com/go/lj500MFP525_firmware).

## Use HP Smart Print (Windows)

Use HP Smart Print to print a particular section of a Web site. You can remove headers, footers, and advertisements, so you minimize waste. The application automatically selects the section of the Web page that you most likely want to print. You can edit the selected area before you print.

Download HP Smart Print from this Web site: [www.hp.com/go/smartweb](http://www.hp.com/go/smartweb).



**NOTE:** HP Smart Print is compatible with Windows browsers only.

---



## Use easy-access USB printing

This product features easy-access USB printing, so you can quickly print files without sending them from a computer. The product accepts standard USB flash drives in the USB port on the front of the product. You can print the following types of files:

- .pdf
- .prn
- .pcl
- .ps
- .cht

Before you can use this feature, you must enable the USB port. Use the following procedure to enable the port from the product control-panel menus:

1. From the Home screen on the product control panel, scroll to and touch the [Administration](#) button.
2. Open the following menus:
  - [General Settings](#)
  - [Enable Retrieve from USB](#)
3. Select the [Enable](#) option, and then touch the [Save](#) button.

## Print easy-access USB documents

1. Insert the USB flash drive into the USB port on the left side of the product control panel.

**NOTE:** You might need to remove the cover from the USB port.

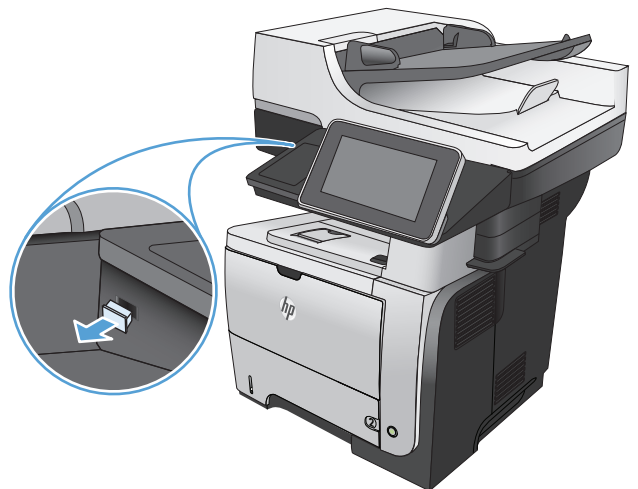

2. The [Retrieve from USB](#) screen opens. Select a folder from the list on the left side of the screen.
3. Select the name of the document that you want to print.

4. To adjust the number of copies, touch the **Copies** field, and then use the keypad to select the number of copies.
5. Touch the Start  button to print the document.

---

# 6 Copy

- [Set new default copy settings](#)
- [Restore default copy settings](#)
- [Make a single copy](#)
- [Make multiple copies](#)
- [Copy a multiple-page original](#)
- [Collate a copy job](#)
- [Copy on both sides \(duplex\)](#)
- [Reduce or enlarge a copy image](#)
- [Optimize copy quality for text or pictures](#)
- [Adjust the copy lightness/darkness](#)
- [Set the paper size and type for copying on special paper](#)
- [Use Job Build mode](#)
- [Copy a book](#)
- [Copy a photo](#)

# Set new default copy settings

You can use the [Administration](#) menu to establish default settings that apply to all copy jobs. If necessary, you can override most settings for an individual job. After that job is complete, the product returns to the default settings.

1. From the Home screen on the product control panel, scroll to and touch the [Administration](#) button.
2. Open the [Copy Settings](#) menu.
3. Several options are available. You can configure defaults for all options, or for only some options.



**NOTE:** To learn about each menu option, touch the Help  button in the upper-right corner of the screen for that option.

Menu item	Description
<a href="#">Copies</a>	Use the <a href="#">Copies</a> feature to set the default number of copies for all copy jobs.
<a href="#">Sides</a>	Use the <a href="#">Sides</a> feature to indicate whether the original document is printed on one or both sides, and whether the copies should be printed on one or both sides.
<a href="#">Collate</a>	When you are making multiple copies of a document, use the <a href="#">Collate</a> feature to assemble each set of pages in the same order as the original document.  Turn off the <a href="#">Collate</a> feature to group the same pages together. For example, if you are making five copies of a document that has two pages, all five first pages would be grouped together and all five second pages would be grouped together.
<a href="#">Reduce/Enlarge</a>	Use the <a href="#">Reduce/Enlarge</a> feature to scale the size of the document up or down.  To reduce the image, select a scaling percentage that is less than 100. To enlarge the image, select a scaling percentage that is greater than 100.
<a href="#">Paper Selection</a>	Use the <a href="#">Paper Selection</a> feature to specify which tray to use for printing copies.
<a href="#">Image Adjustment</a>	Use the <a href="#">Image Adjustment</a> feature to improve the overall quality of the copy.
<a href="#">Content Orientation</a>	Use the <a href="#">Content Orientation</a> feature to specify the direction of the content on the page of the original document.
<a href="#">Optimize Text/Picture</a>	Use the <a href="#">Optimize Text/Picture</a> feature to optimize the output for a particular type of content: text, printed pictures, or photographs.
<a href="#">Pages per Sheet</a>	Use the <a href="#">Pages per Sheet</a> feature to copy multiple pages onto one sheet of paper.
<a href="#">Original Size</a>	Use the <a href="#">Original Size</a> feature to describe the page size of the original document.
<a href="#">Booklet Format</a>	Use the <a href="#">Booklet Format</a> feature to copy two or more pages onto one sheet of paper so you can fold the sheets in the center to form a booklet. The product arranges the pages in the correct order. For example, if the original document has eight pages, the product prints pages 1 and 8 on the same sheet.

---

<b>Menu item</b>	<b>Description</b>
Edge-To-Edge	Use the <a href="#">Edge-To-Edge</a> feature to avoid shadows that can appear along the edges of copies when the original document is printed close to the edges. Combine this feature with the <a href="#">Reduce/Enlarge</a> feature to ensure that the entire page is printed on the copies.
Job Build	Use the <a href="#">Job Build</a> feature to divide a complex job into smaller segments. This is useful when you are copying or scanning an original document that has more pages than the document feeder can hold, or when you want to combine pages that have different sizes into one job.

---

# Restore default copy settings

1. From the Home screen on the product control panel, scroll to and touch the [Administration](#) button.
2. Open the following menus:
  - [General Settings](#)
  - [Restore Factory Settings](#)
3. Select the [Copy](#) check box, and then touch the [Reset](#) button.
4. A verification message advises that completing the reset function might result in loss of data. Touch the [Reset](#) button to complete the process.



**NOTE:** The product restarts automatically after the reset operation completes.

---

## Make a single copy

1. Place the document face-down on the scanner glass, or place it face-up in the document feeder and adjust the paper guides to fit the size of the document.

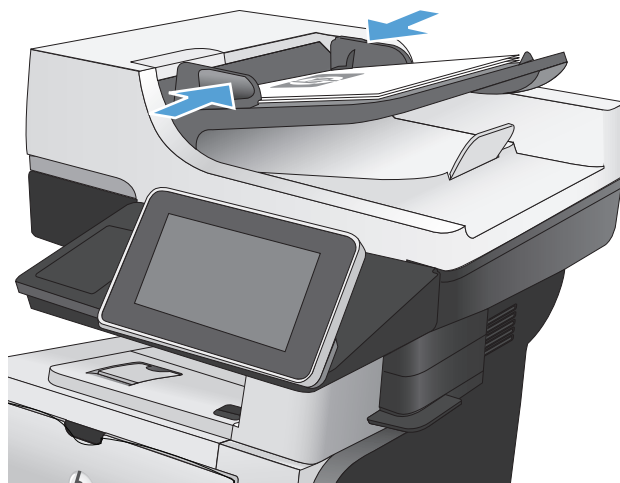

2. From the Home screen on the product control panel, touch the Start button.

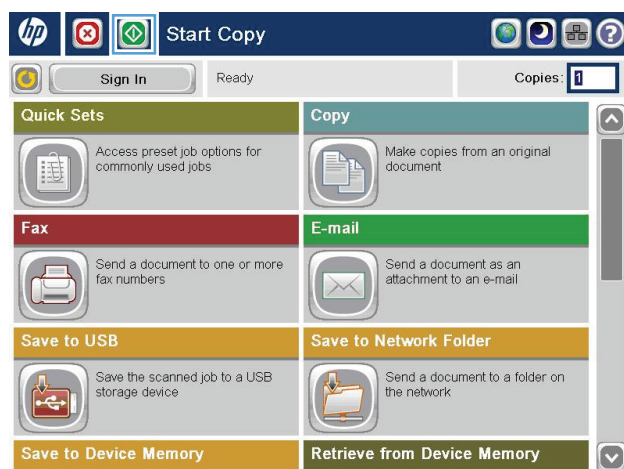

# Make multiple copies

1. Place the document face-down on the scanner glass, or place it face-up in the document feeder and adjust the paper guides to fit the size of the document.

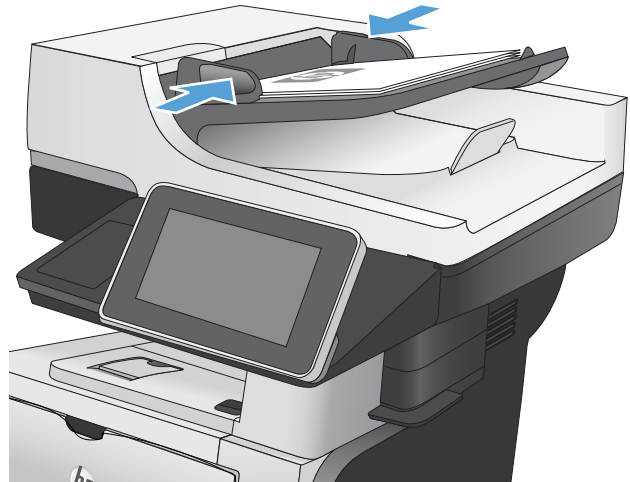

2. From the Home screen on the product control panel, touch the **Copy** button.



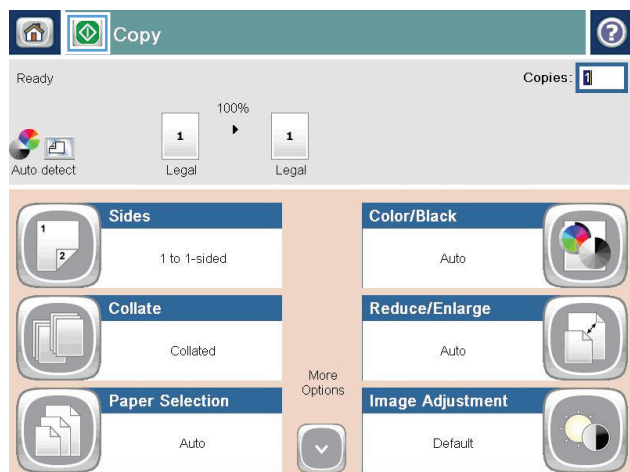

3. Touch the **Copies** field to open a keypad.



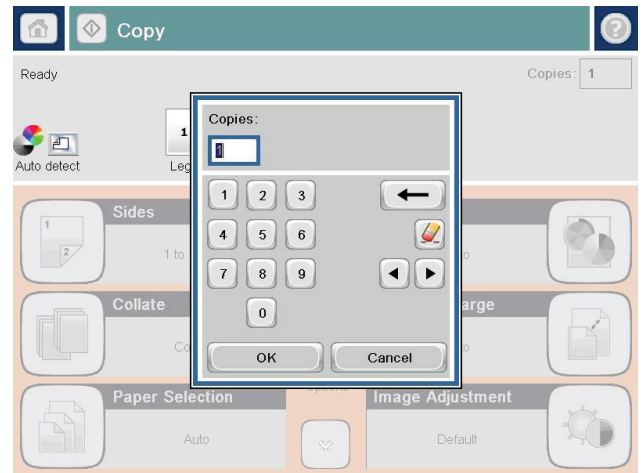

4. Enter the number of copies, and then touch the **OK** button.



5. Touch the Start  button.

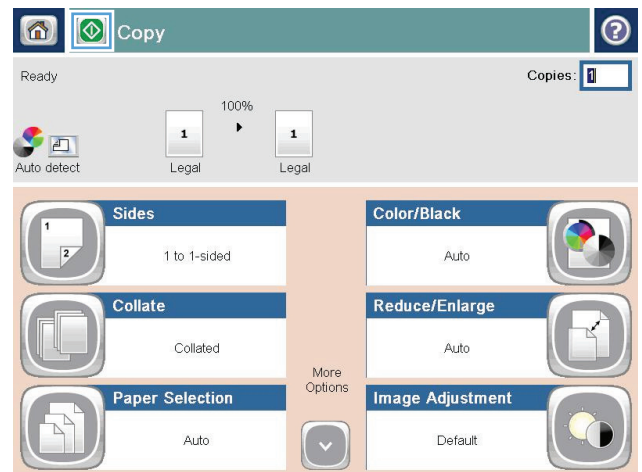

# Copy a multiple-page original

The document feeder holds up to 50 pages (depending on the thickness of the pages).

1. Place the document into the document feeder with the pages facing up. Adjust the paper guides to fit the size of the document.

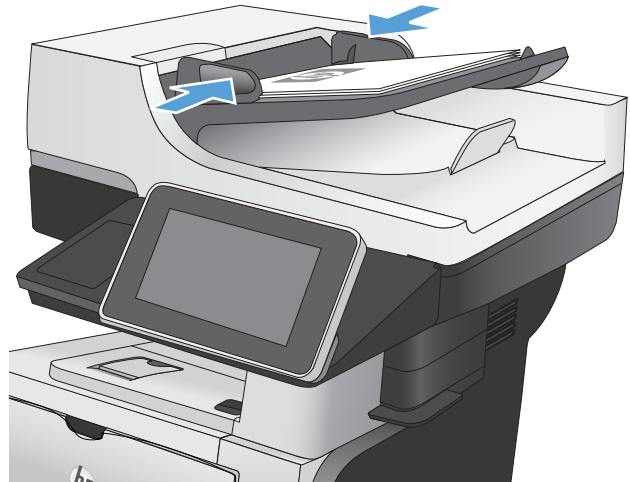

2. From the Home screen on the product control panel, touch the **Copy** button.



3. Touch the **Copies** field to open a keypad.

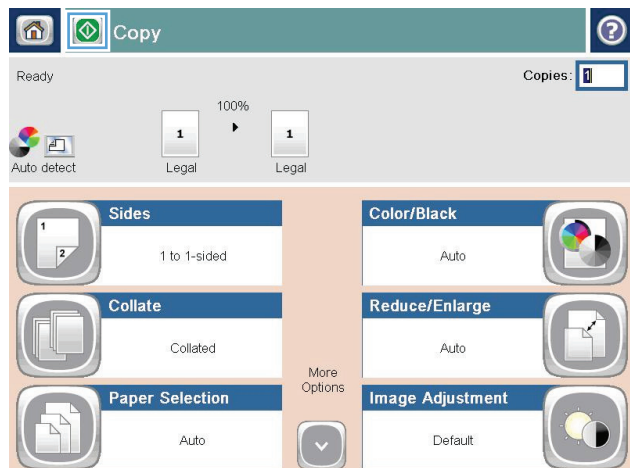

4. Enter the number of copies, and then touch the OK button.

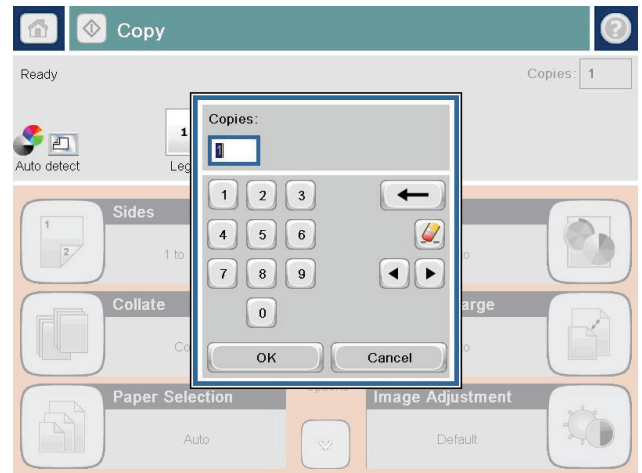

5. Touch the Start button.

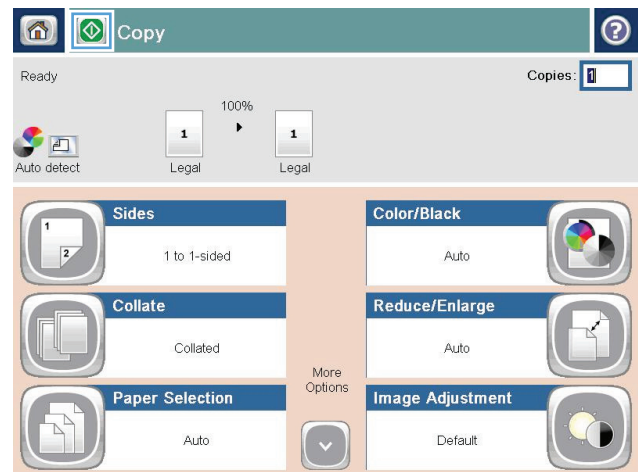

# Collate a copy job

1. From the Home screen on the product control panel, touch the **Copy** button.

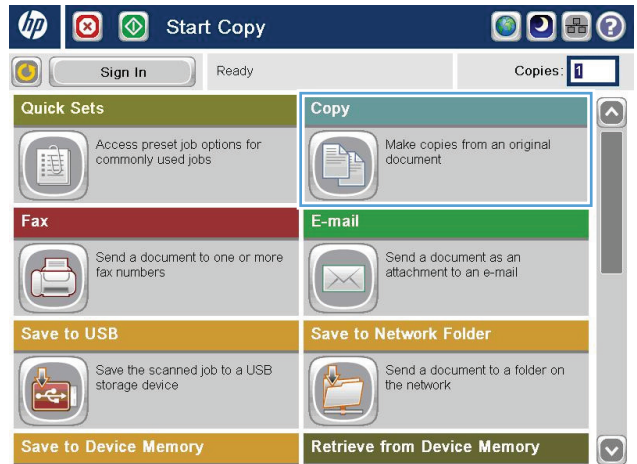

2. Touch the **Collate** button.

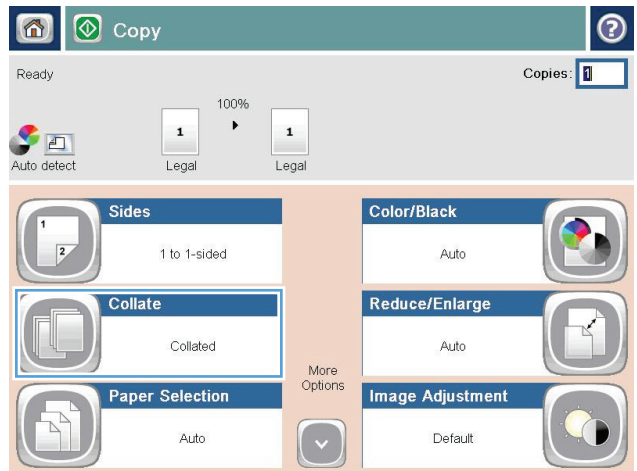

3. Touch the **Collate on (Sets in page order)** option. Touch the **OK** button.

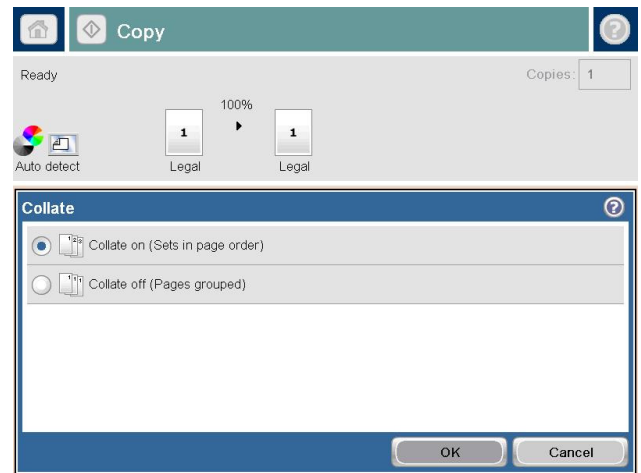

4. Touch the **Start** button.

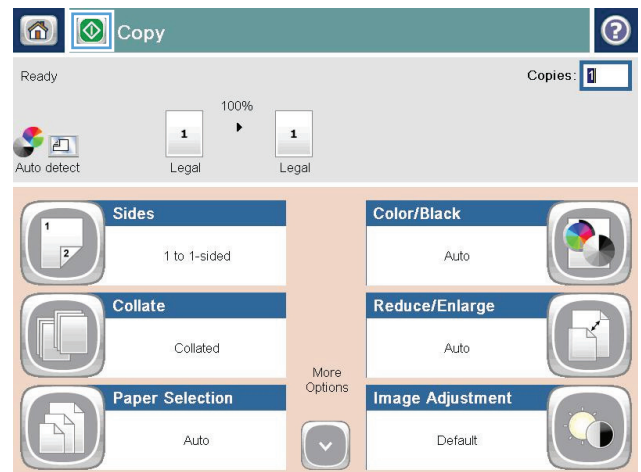

# Copy on both sides (duplex)

## Copy on both sides automatically

1. Load the original documents into the document feeder with the first page facing up, and with the top of the page leading.

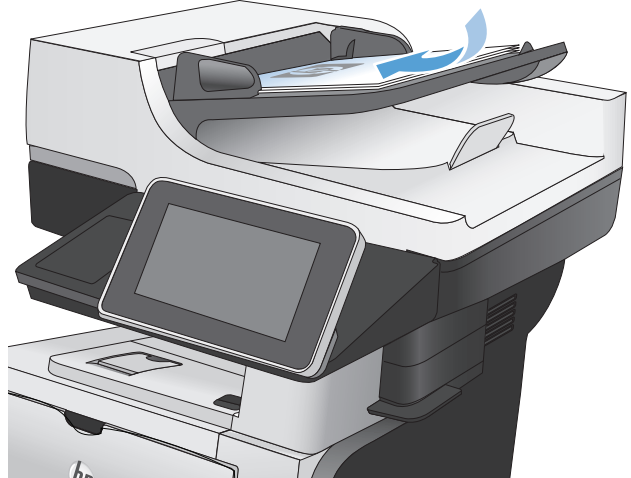

2. Adjust the paper guides to fit the size of the document.

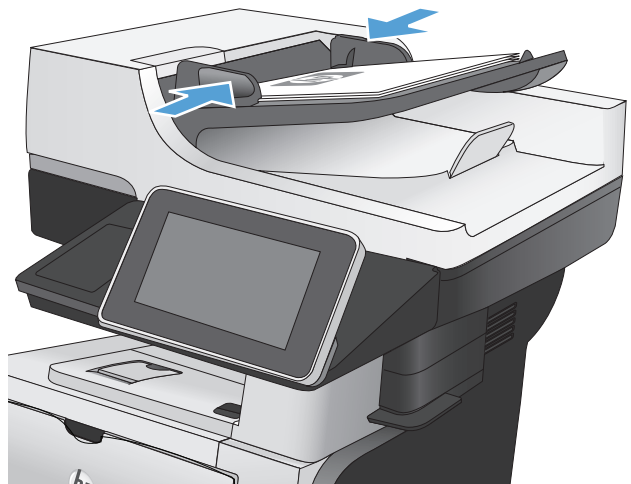

3. From the Home screen on the product control panel, touch the **Copy** button.
4. Touch the **Sides** button.

5. To make a two-sided copy from a one-sided original, touch the **1-sided original, 2-sided output** button.

To make a two-sided copy from a two-sided original, touch the **2-sided original, 2-sided output** button.

To make a one-sided copy from a two-sided original, touch the **2-sided original, 1-sided output** button.

Touch the **OK** button.

6. Touch the **Start**  button.

## Copy on both sides manually

1. Lift the scanner lid.

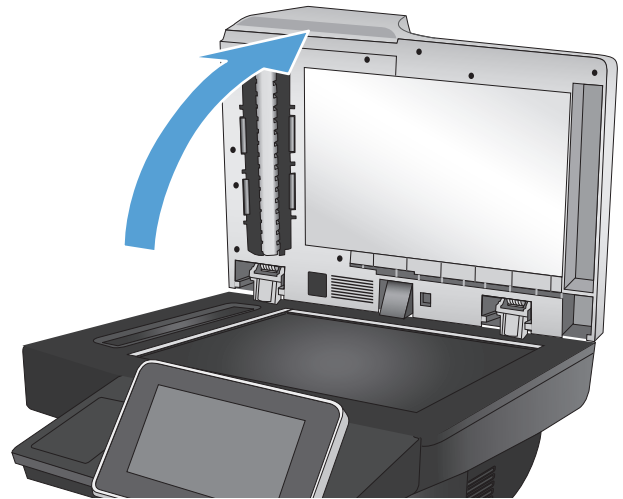

2. Place the document face-down on the scanner glass with the upper-left corner of the page in the upper-left corner of the glass.

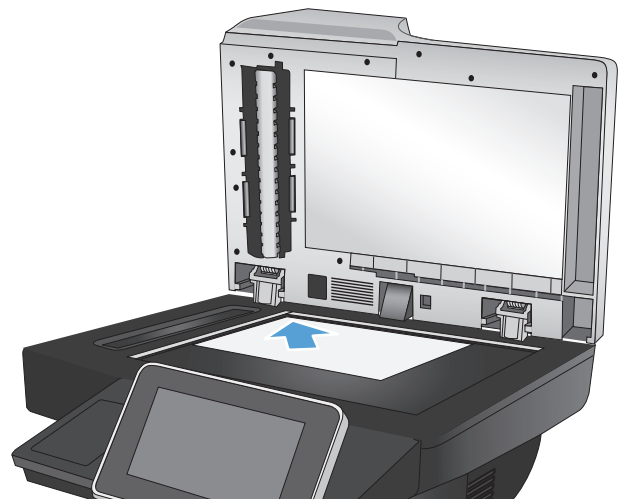

3. Gently close the scanner lid.

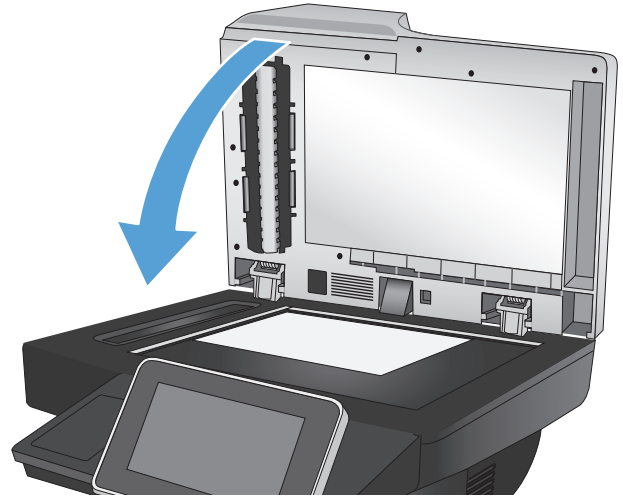

4. From the Home screen on the product control panel, touch the **Copy** button.
5. Touch the **Sides** button.
6. To make a two-sided copy from a one-sided original, touch the **1-sided original, 2-sided output** button.

To make a two-sided copy from a two-sided original, touch the **2-sided original, 2-sided output** button.

To make a one-sided copy from a two-sided original, touch the **2-sided original, 1-sided output** button.

Touch the **OK** button.

7. Touch the **Start**  button.
8. The product prompts you to load the next original document. Place it on the glass, and then touch the **Scan** button.
9. The product temporarily saves the scanned images. Touch the **Finish** button to finish printing the copies.



# Reduce or enlarge a copy image

1. From the Home screen on the product control panel, touch the **Copy** button.

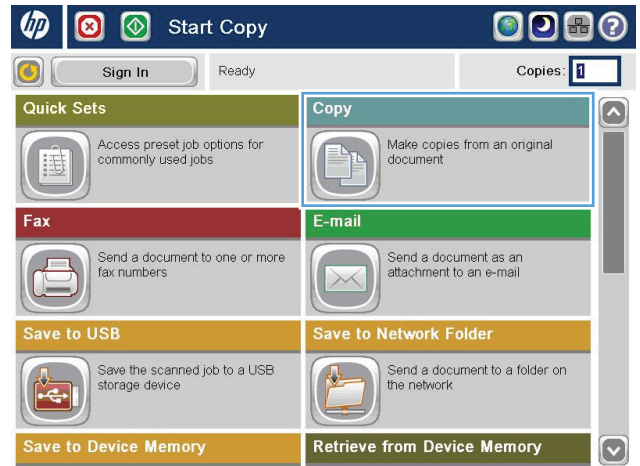

2. Touch the **Reduce/Enlarge** button.

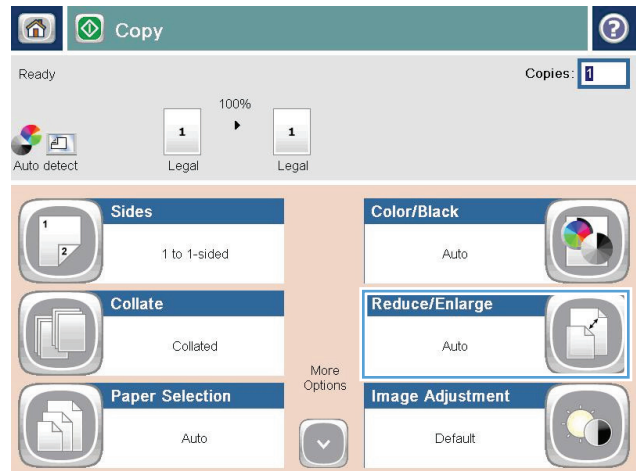

3. Select one of the predefined percentages, or touch the **Scaling** field and type a percentage between 25 and 200 when using the document feeder or between 25 and 400 when copying from the scanner glass. Touch the **OK** button. You can also select these options:

- **Auto**: The product automatically scales the image to fit the paper size in the tray.
- **Auto Include Margins**: The product reduces the image slightly to fit the entire scanned image within the printable area on the page.

**NOTE:** To reduce the image, select a scaling percentage that is less than 100. To enlarge the image, select a scaling percentage that is greater than 100.

4. Touch the Start  button.

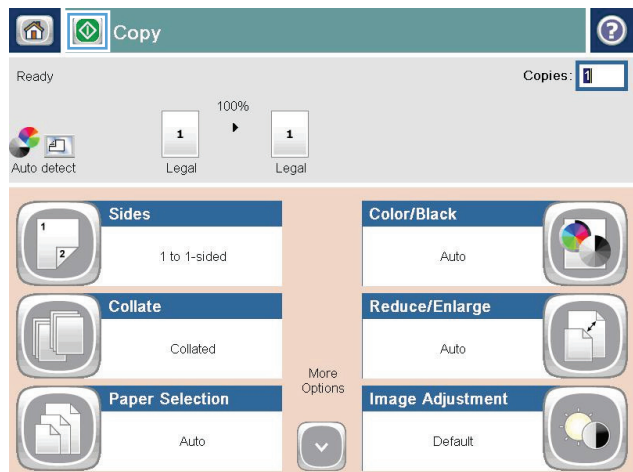
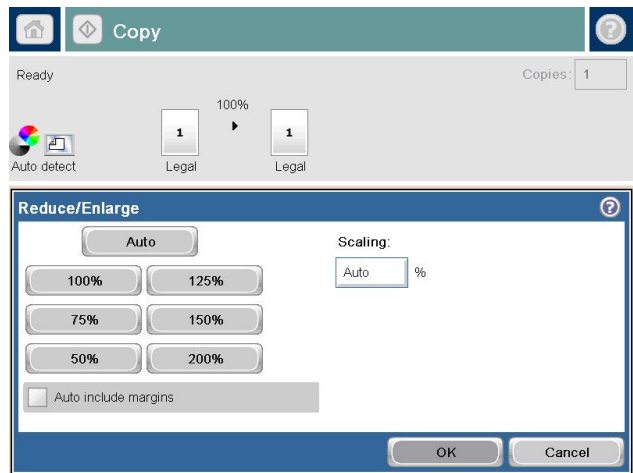

## Optimize copy quality for text or pictures

Optimize the copy job for the type of image being copied: text, graphics, or photos.

1. From the Home screen on the product control panel, touch the **Copy** button.
2. Touch the **More Options** button, and then touch the **Optimize Text/Picture** button.
3. Select one of the predefined options, or touch the **Manually adjust** button and then adjust the slider in the **Optimize For** area. Touch the **OK** button.
4. Touch the Start  button.

---

 **NOTE:** These settings are temporary. After you have finished the job, the product returns to the default settings.

---

# Adjust the copy lightness/darkness

1. From the Home screen on the product control panel, touch the **Copy** button.

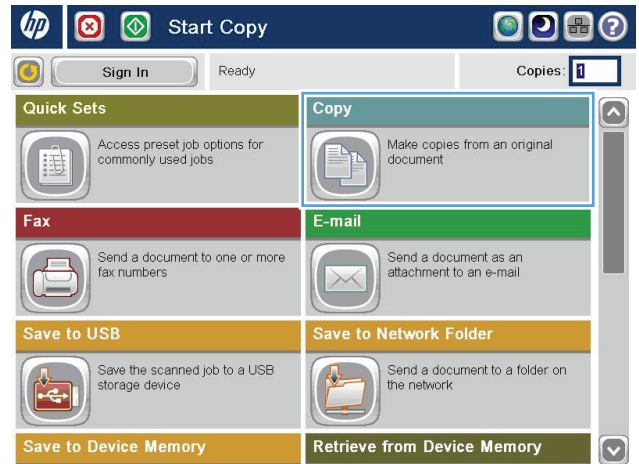

2. Touch the **Image Adjustment** button.

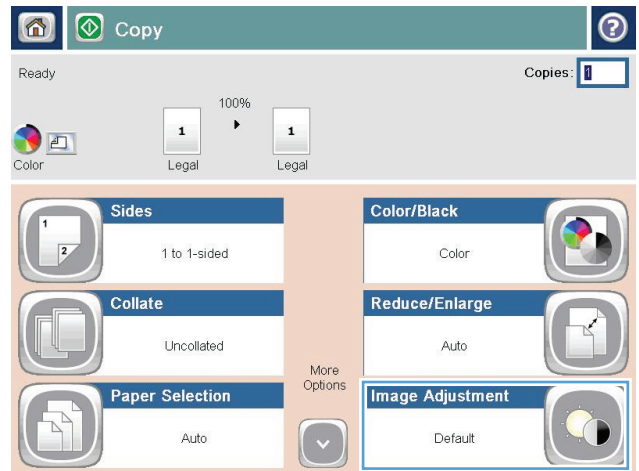

- Adjust the sliders to set the **Darkness** level, the **Contrast** level, the **Sharpness** level, and the **Background Cleanup** level. Touch the **OK** button.

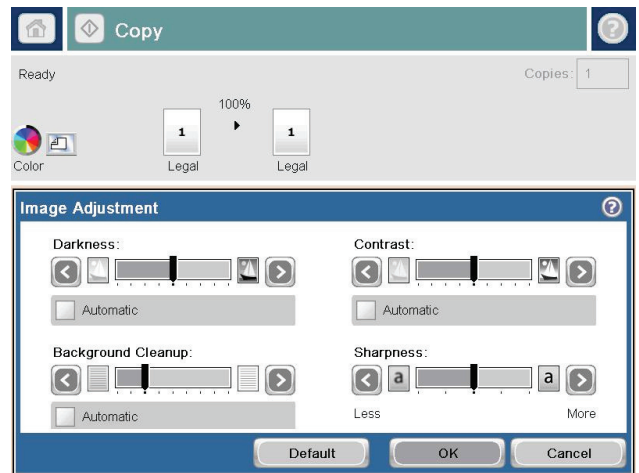

- Touch the Start button.

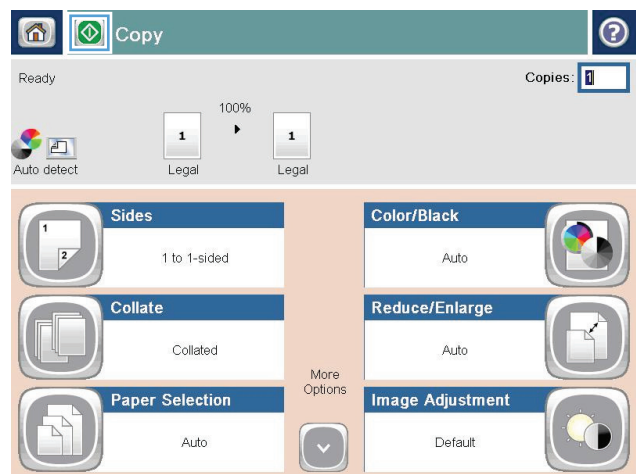

# Set the paper size and type for copying on special paper

1. From the Home screen on the product control panel, touch the **Copy** button.

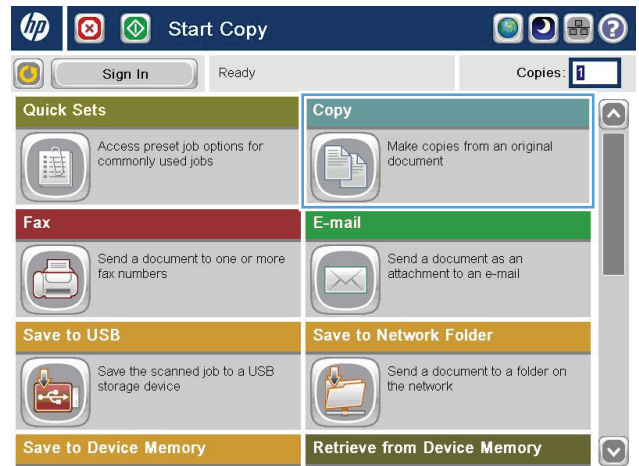

2. Touch the **Paper Selection** button.

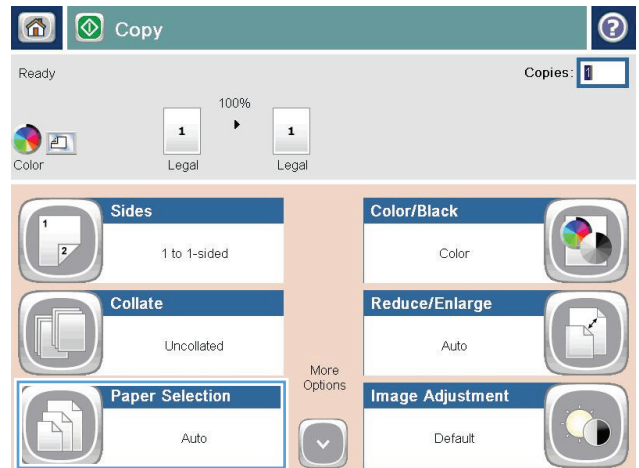

3. Select the tray that holds the paper that you want to use, and then touch the **OK** button.

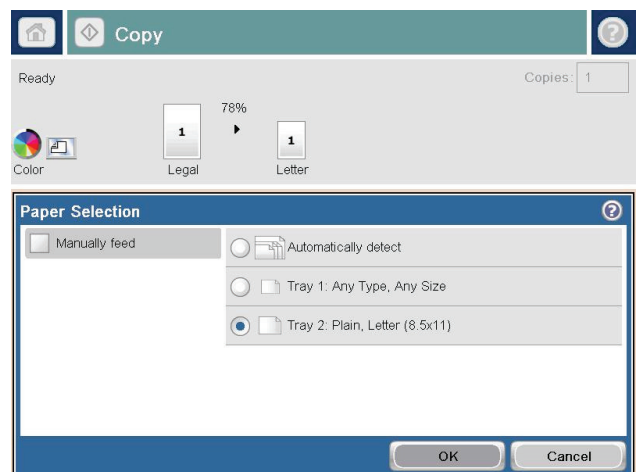

## Use Job Build mode

Use the **Job Build** feature to combine several sets of original documents into one copy job. Also use this feature to copy an original document that has more pages than the document feeder can accommodate at one time.

1. Place the document face-down on the scanner glass, or place it face-up in the document feeder and adjust the paper guides to fit the size of the document.
2. From the Home screen on the product control panel, touch the **Copy** button.
3. Touch the **More Options** button, and then touch the **Job Build** button.
4. Touch the **Job Build on** button.
5. Touch the **OK** button.
6. If necessary, select copy options.
7. Touch the Start  button. After each page is scanned, the control panel prompts you for more pages.
8. If the job contains more pages, load the next page, and then touch the **Scan** button.

The product temporarily saves all the scanned images. Touch the **Finish** button to print the copy job.

# Copy a book

1. Lift the scanner lid.

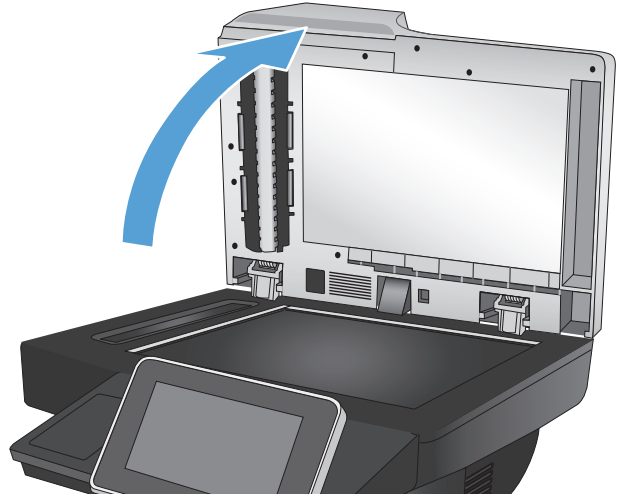

2. Place the book on the scanner glass with the spine aligned with the mark on the rear, center of the scanner glass.

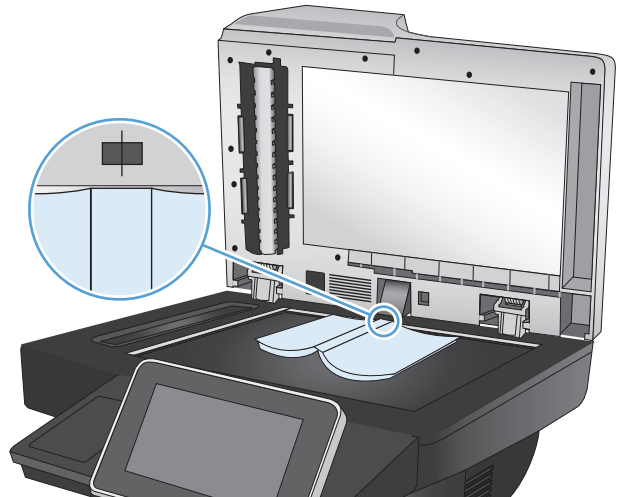

3. Gently close the scanner lid.

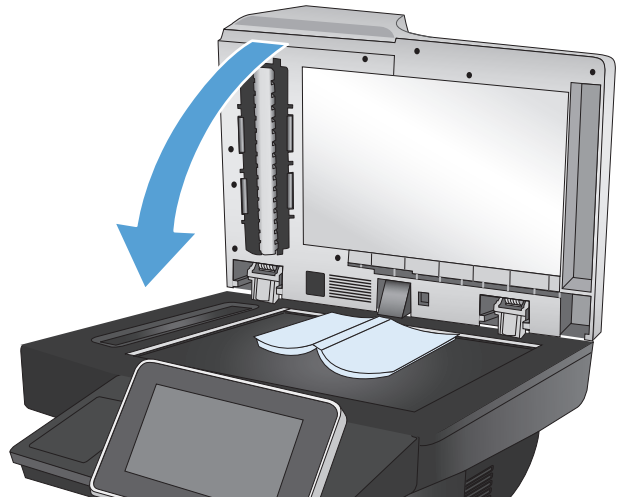



- From the Home screen on the product control panel, touch the Start  button.

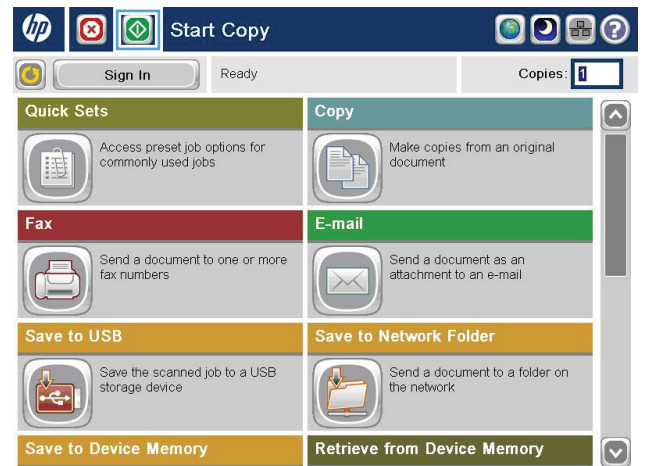

- Repeat these steps for each page that you want to copy.

 **NOTE:** This product does not have the capability to distinguish left and right pages. Assemble the copied pages carefully.

# Copy a photo

Copy photos from the scanner glass.

1. Lift the scanner lid.

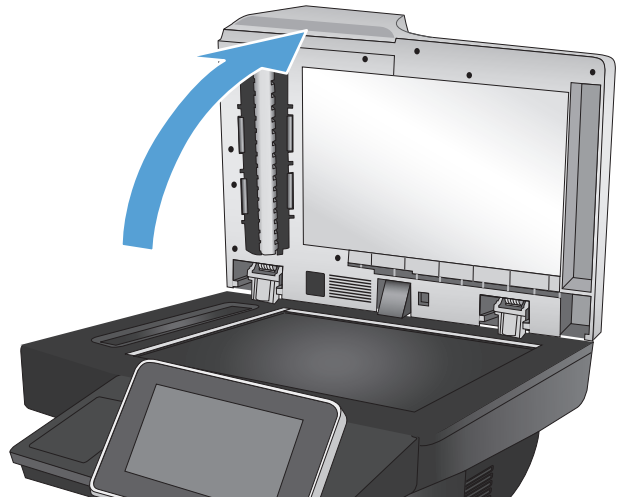

2. Place the photo on the scanner glass with the picture-side down and the upper-left corner of the photo in the upper-left corner of the glass.

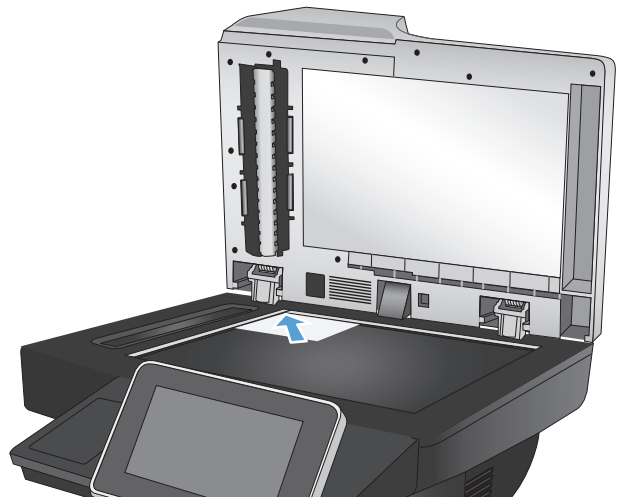

3. Gently close the scanner lid.

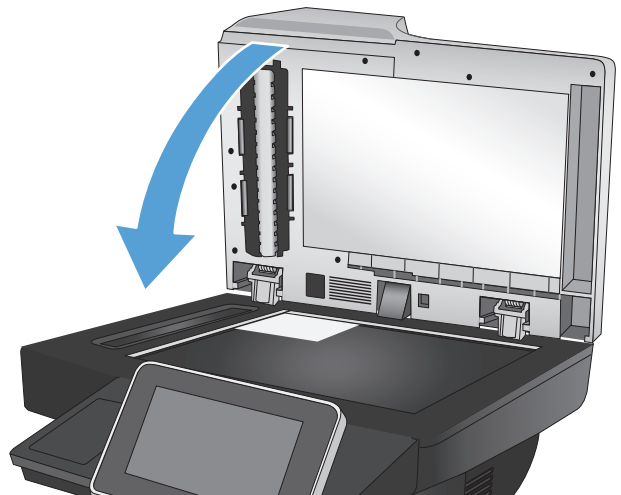

4. From the Home screen on the product control panel, touch the **Copy** button.
5. Touch the **More Options** button at the bottom of the screen.
6. Touch the **Optimize Text/Picture** button.
7. Select the **Photograph** option, and then touch the **OK** button.
8. Touch the Start  button.



---

# 7 Scan/send

- [Set up scan/send features](#)
- [Change default scan/send settings from the product control panel](#)
- [Send a scanned document to a network folder](#)
- [Send a scanned document to a folder in the product memory](#)
- [Send a scanned document to a USB flash drive](#)
- [Send a scanned document to one or more email addresses](#)
- [Use the address book to send email](#)
- [Scan a photo](#)

# Set up scan/send features

The product offers the following scan and send features:

- Scan and save files to a folder on your network.
- Scan and save files to the product memory.
- Scan and save files to a USB flash drive.
- Scan and send documents to one or more email addresses.

Some scan and send features are not available on the product control panel until you use the HP Embedded Web Server to enable them.

 **NOTE:** To find detailed information about using the HP Embedded Web Server, click the **Help** link in the upper-right corner of each HP Embedded Web Server page.

1. Open a Web page, and then enter the product IP address in the address line.
2. When the HP Embedded Web Server opens, click the **Scan/Digital Send** tab.
3. If you did not set up the **E-mail** feature during software installation, you can enable it by using the HP Embedded Web Server.
  - a. Click the **E-mail Setup** link.
  - b. Select the **E-mail** check box to enable the feature.
  - c. Select the outgoing mail server to use, or click the **Add** button to add a different server to the list. Follow the on-screen prompts.

 **NOTE:** If you do not know the name of the mail server, you can usually find it by opening your email program and looking at the outgoing mail configuration settings.

- d. In the **Address Message** area, configure the default setting for the From address.
  - e. Configuring the other settings is optional.
  - f. Click the **Apply** button at the bottom of the page.
4. Enable the **Save to Network Folder** feature.
    - a. Click the **Save to Network Folder Setup** link.
    - b. Select the **Save to Network Folder** check box to enable the feature.
    - c. In the **Quick Sets** area, click the **Add** button.
    - d. On the next screen, provide a name and a description for the Quick Set and specify the location where you want the Quick Set to appear on the control panel. Click the **Next** button.
    - e. On the next screen, select the type of Quick Set folder to use, and then click the **Next** button.



# Change default scan/send settings from the product control panel

1. From the Home screen on the product control panel, scroll to and touch the **Administration** button.

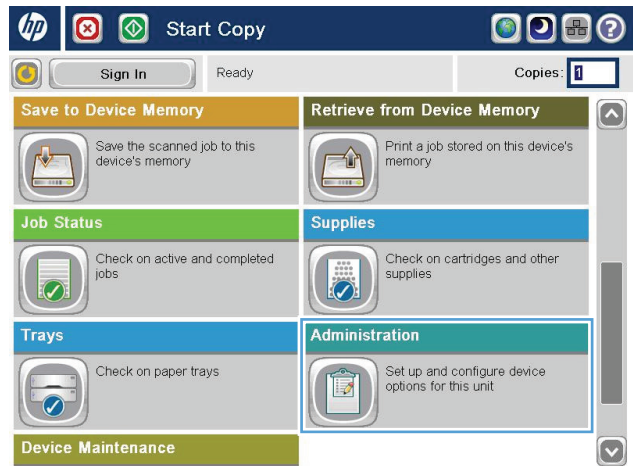

2. Open the **Scan/Digital Send Settings** menu.

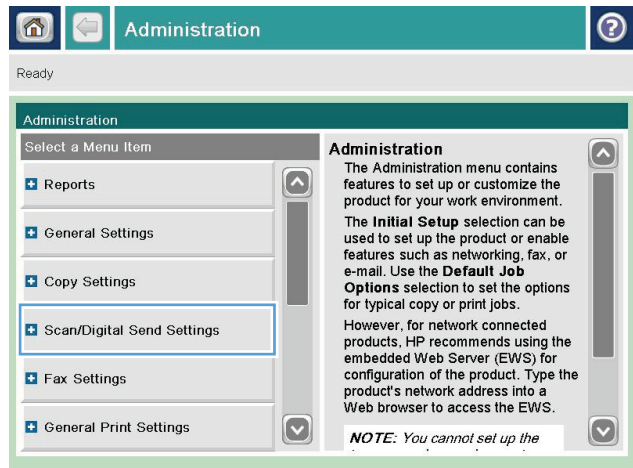



3. Select the category of scan and send settings that you want to configure.

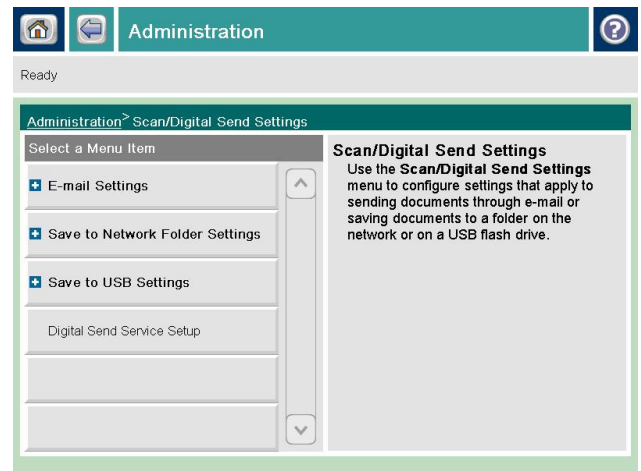

4. Open the Default Job Options menu, and configure the options. Touch the Save button to save the settings.

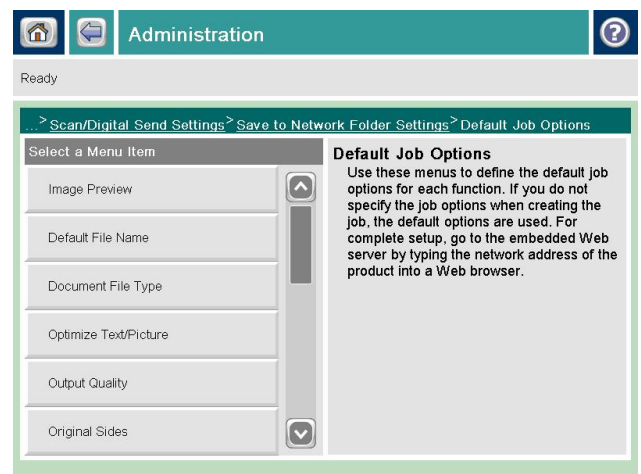

# Send a scanned document to a network folder

The product can scan a file and save it in a folder on the network. The following operating systems support this feature:

- Windows Server 2003, 64-bit
- Windows Server 2008, 64-bit
- Windows XP, 64-bit
- Windows Vista, 64-bit
- Windows 7, 64-bit
- Novell v5.1 and later (access to the [Quick Sets](#) folders only)

 **NOTE:** You might be required to sign in to the product to use this feature.

The system administrator can use the HP Embedded Web Server to configure pre-defined [Quick Sets](#) folders, or you can provide the path to another network folder.

1. Place the document face-down on the scanner glass, or place it face-up in the document feeder and adjust the paper guides to fit the size of the document.

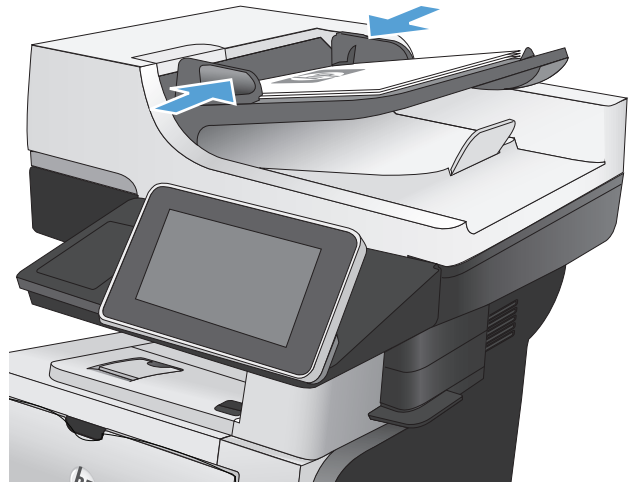

2. From the Home screen on the product control panel, touch the [Save to Network Folder](#) button.

**NOTE:** If prompted, type your user name and password.

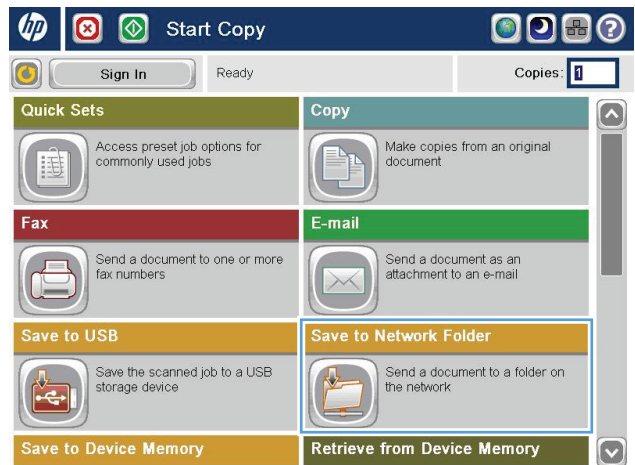

3. To use one of the preset job settings, select one of the items in the **Quick Sets** list.

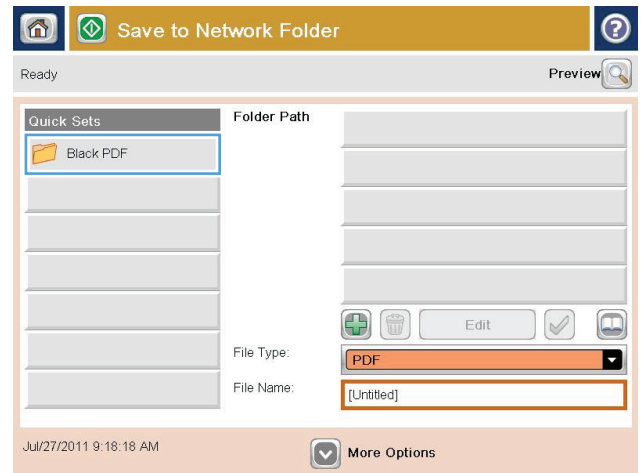

4. To set up a new job, type the name for the file in the **File Name:** text field, and type the path to the network folder in the **Folder Path** field. Use this format for the path:

\\path\path

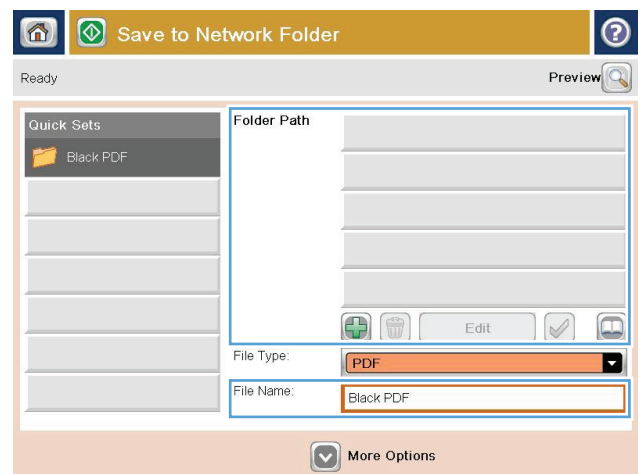

5. To configure settings for the document, touch the **More Options** button.

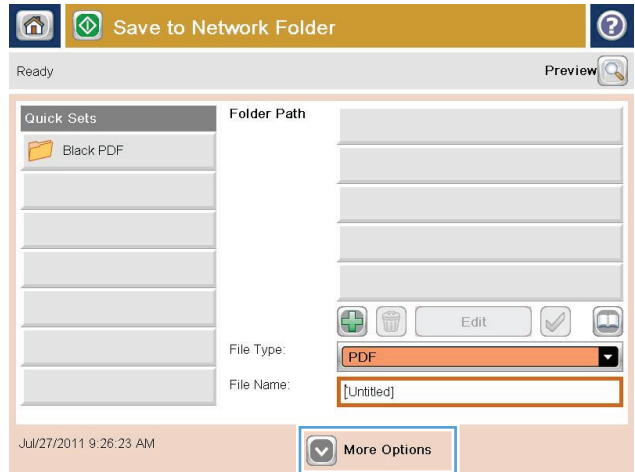

6. Touch the Start  button to save the file.

**NOTE:** You can preview the image at any time by touching the **Preview** button in the upper-right corner of the screen. For more information about this feature, touch the **Help**  button on the preview screen.

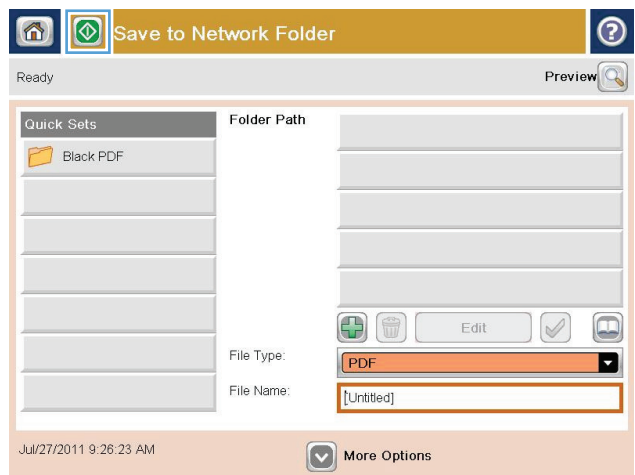

# Send a scanned document to a folder in the product memory

Use this procedure to scan a document and save it on the product so you can print copies at any time.

1. Place the document face-down on the scanner glass, or place it face-up in the document feeder and adjust the paper guides to fit the size of the document.

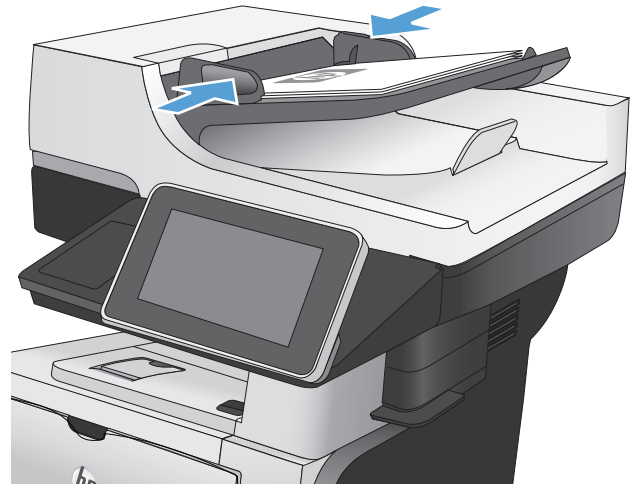

2. From the Home screen on the product control panel, scroll to and touch the [Save to Device Memory](#) button.

**NOTE:** If prompted, enter your user name and password.

3. Select an existing folder, or touch the [New Folder](#) button to create a new folder.
4. Enter the name for the file in the [File Name:](#) field.
5. To configure settings for the document, touch the [More Options](#) button.
6. Touch the Start  button to save the file.

# Send a scanned document to a USB flash drive

The product can scan a file and save it in a folder on a USB flash drive.



**NOTE:** You might be required to sign in to the product to use this feature.

1. Place the document face-down on the scanner glass, or place it face-up in the document feeder and adjust the paper guides to fit the size of the document.

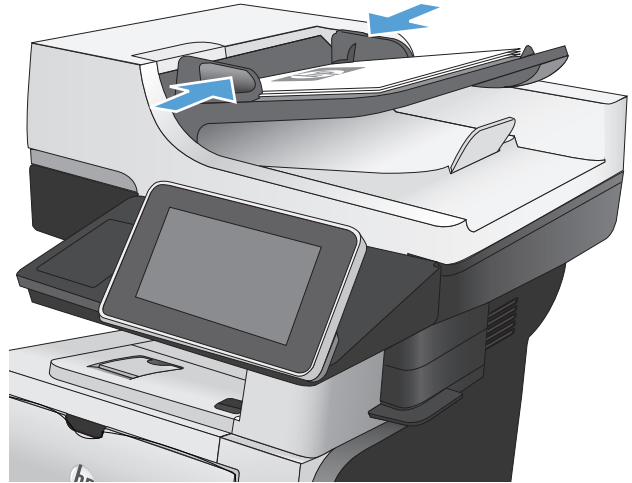

2. Insert the USB flash drive into the USB port on the left side of the product control panel.

**NOTE:** You might need to remove the cover from the USB port.

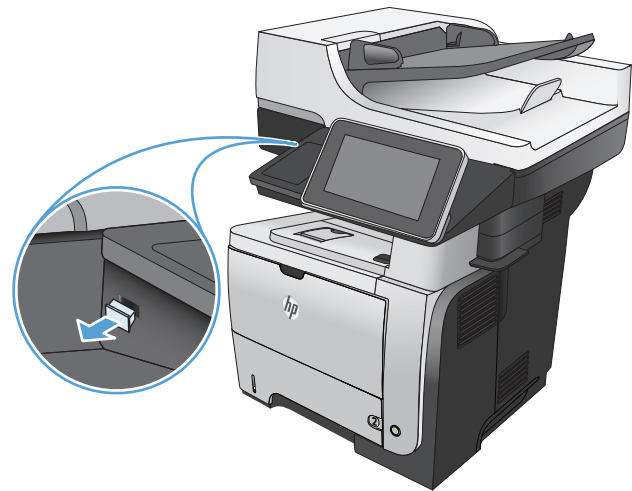

- From the Home screen on the product control panel, scroll to and touch the **Save to USB** button.

**NOTE:** If prompted, enter your user name and password.

- Select one of the folders in the list, or touch the **New Folder** button to create a new folder on the USB flash drive.

- Enter the name for the file in the **File Name:** field. Touch the **OK** button. Select the file type from the **File Type** drop-down list. Touch the **OK** button.

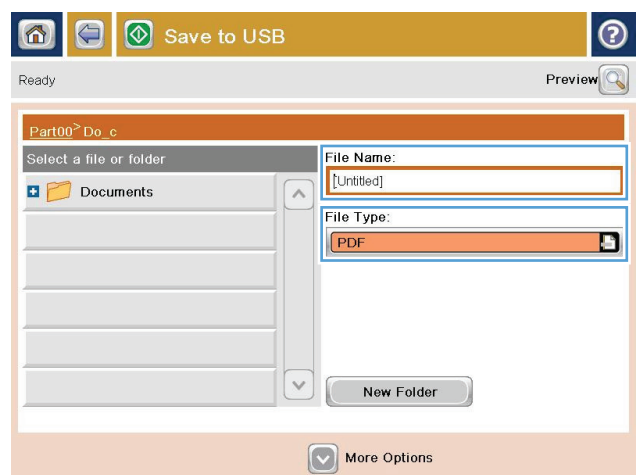
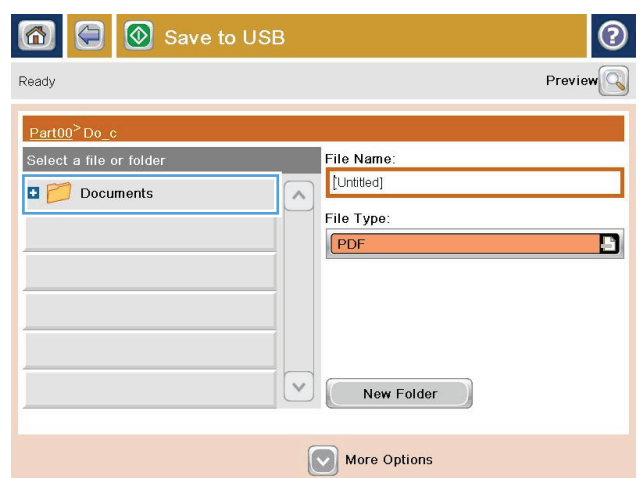
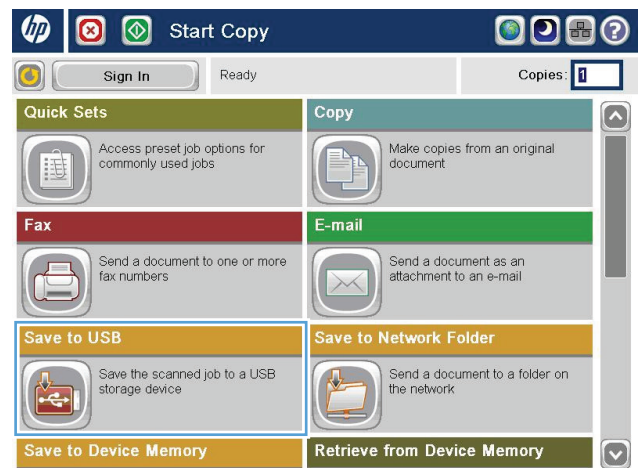

6. To configure settings for the document, touch the **More Options** button.



7. Touch the Start button to save the file.

**NOTE:** You can preview the image at any time by touching the **Preview** button in the upper-right corner of the screen. For more information about this feature, touch the **Help** button on the preview screen.





# Send a scanned document to one or more email addresses

1. Place the document face-down on the scanner glass, or place it face-up in the document feeder and adjust the paper guides to fit the size of the document.

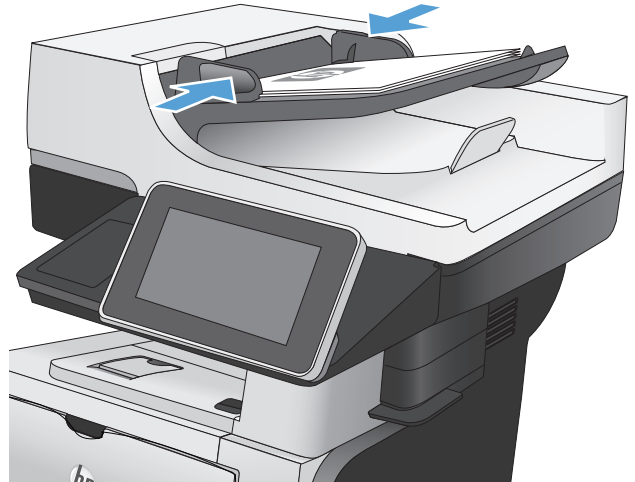

2. From the Home screen on the product control panel, touch the **E-mail** button.

**NOTE:** If prompted, type your user name and password.

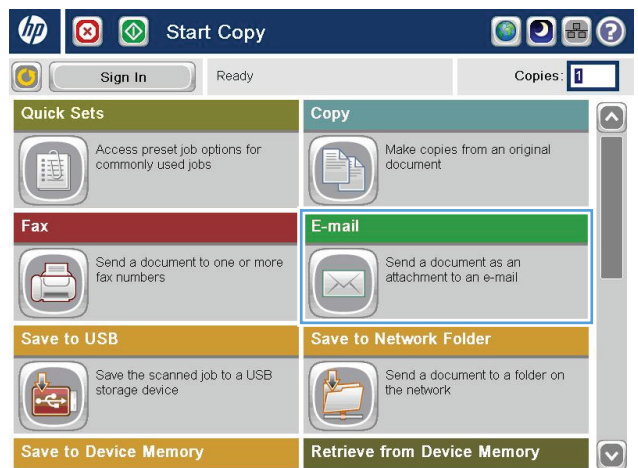

3. Touch the **To** field to open a keypad.

**NOTE:** If you are signed in to the product, your user name or other default information might appear in the **From:** field. If so, you might not be able to change it.

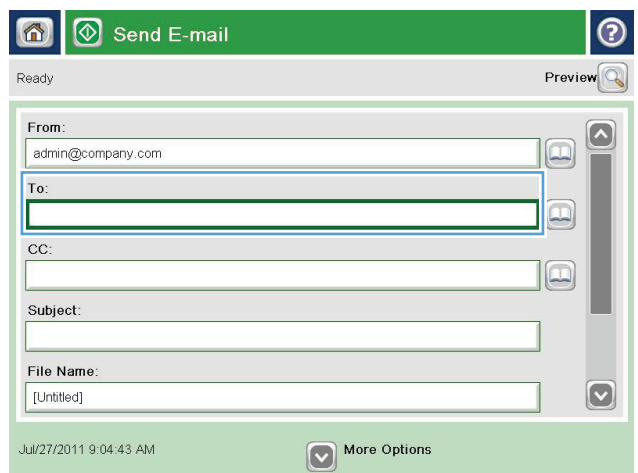

- 4. To send to multiple addresses, separate the addresses with a semicolon, or touch the **Enter** button on the touchscreen keypad after you type each address.

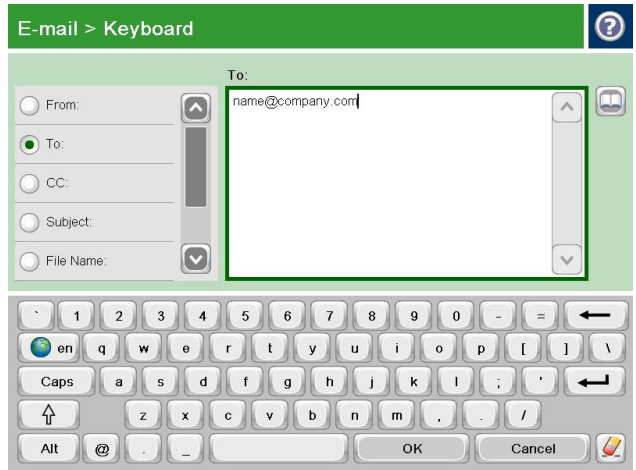

- 5. Complete the **CC:**, **Subject:**, and **File Name:** fields by touching the field and using the touchscreen keypad to enter information.
- 6. To change the settings for the document touch the **More Options** button.

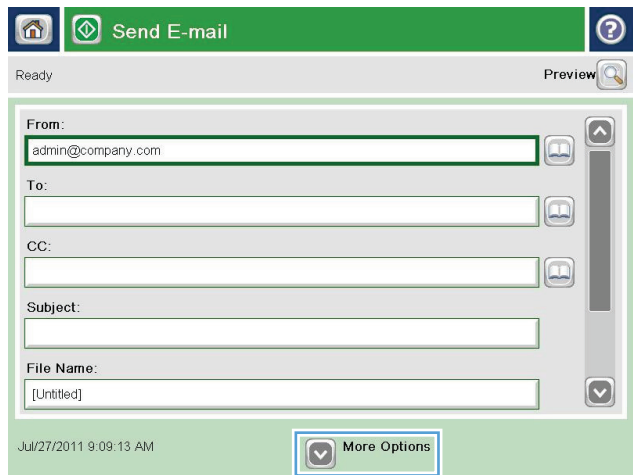

- 7. If you are sending a two-sided document, select the **Original Sides** menu and select the **2-sided** option. Touch the **OK** button.

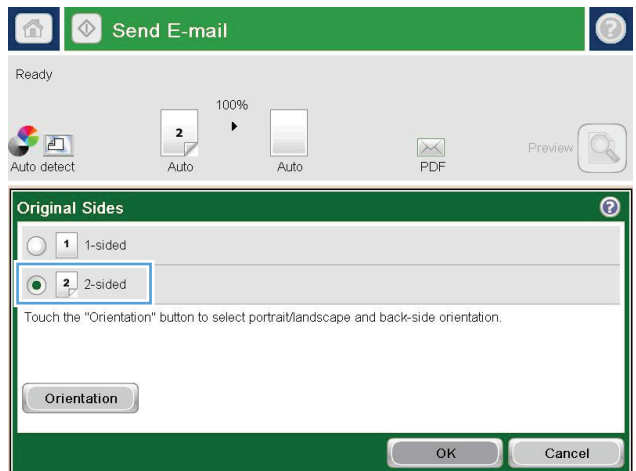

8. Touch the Start  button to begin sending.

**NOTE:** You can preview the image at any time by touching the [Preview](#) button in the upper-right corner of the screen. For more information about this feature, touch the [Help](#)  button on the preview screen.

9. To set up another email job, touch the [OK](#) button on the Status screen.

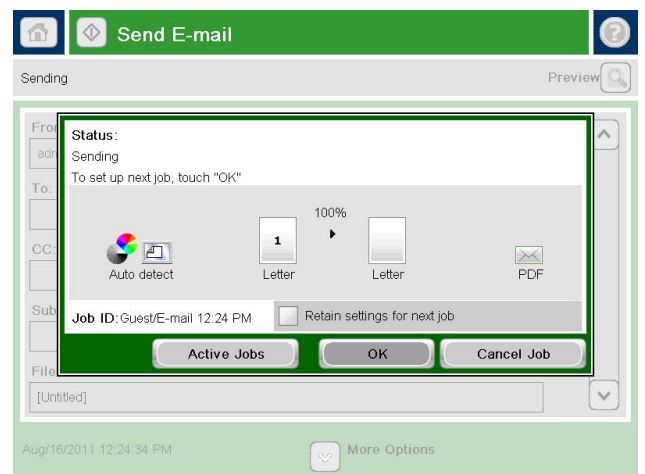
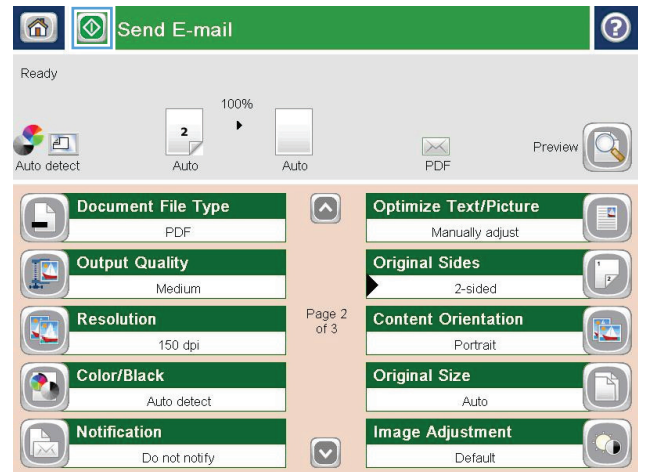

# Use the address book to send email

You can send email to a list of recipients by using the address book. Depending on how the product is configured, you might have one or more of the following address book viewing options.

- **All Contacts:** Lists all the contacts that are available to you.
- **Personal Contacts:** Lists all the contacts that are associated with your user name. These contacts are not visible to other people who use the product.

 **NOTE:** You must be signed in to the product to see the **Personal Contacts** list.

- **Local Contacts:** Lists all the contacts that are stored in the product memory. These contacts are visible to all people who use the product.

## Add contacts to the address book from the product control panel

If you are signed in to the product, contacts that you add to the address book will not be visible to other people who use the product.

If you are not signed in to the product, contacts that you add to the address book will be visible to all people who use the product.

 **NOTE:** You can also use the HP Embedded Web Server (EWS) to create and manage the address book.

1. From the Home screen on the product control panel, touch the **E-mail** button.

**NOTE:** If prompted, enter your user name and password.



2. Touch the Address Book  button that is next to the To: field to open the Address Book screen.

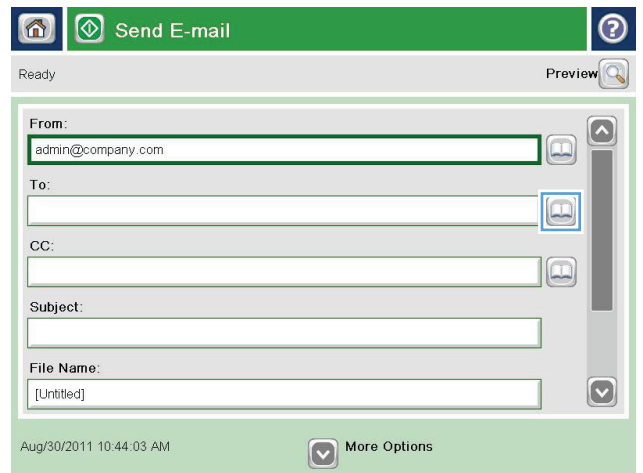

3. Touch the Add  that is in the lower left corner of the screen.

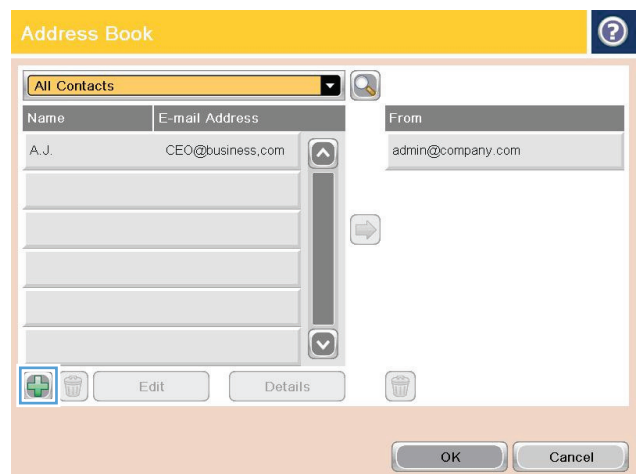

4. In the **Name** field, enter the name of the contact.

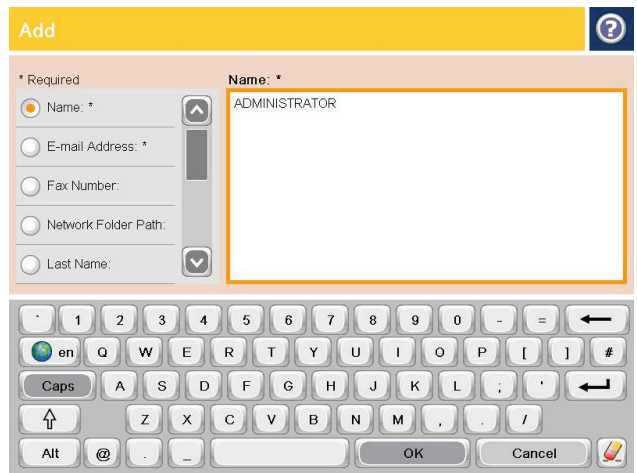

5. From the menu list, select the **E-mail Address** option, and then enter the contact's email address.

Touch the **OK** button to add the contact to the list.

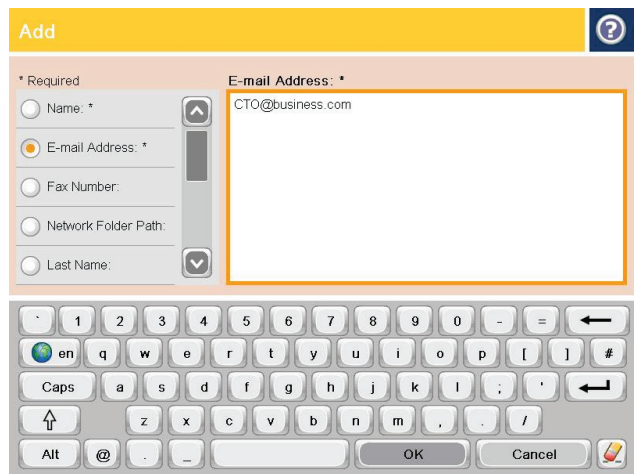

## Send a document to email by using the address book

1. Place the document face-down on the scanner glass, or place it face-up in the document feeder and adjust the paper guides to fit the size of the document.

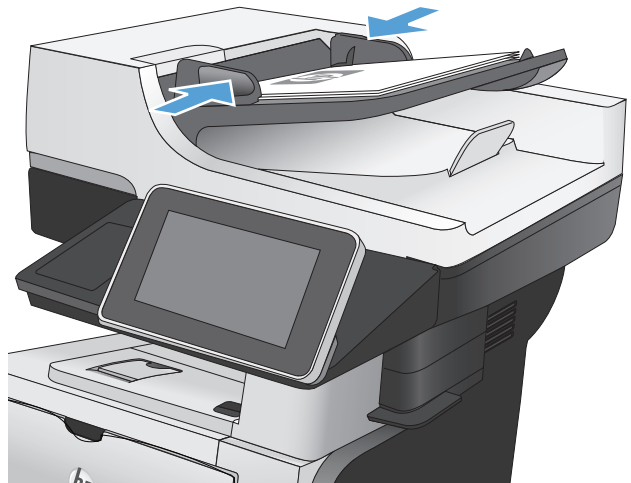



- From the Home screen on the product control panel, touch the **E-mail** button.

**NOTE:** If prompted, enter your user name and password.

- Touch the Address Book  button that is next to the **To:** field to open the **Address Book** screen.

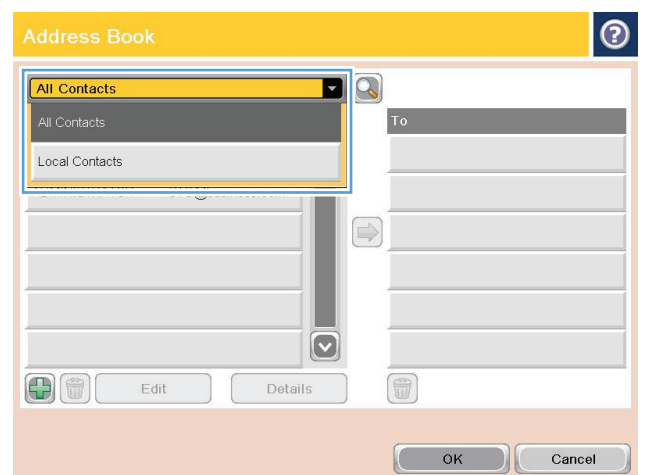
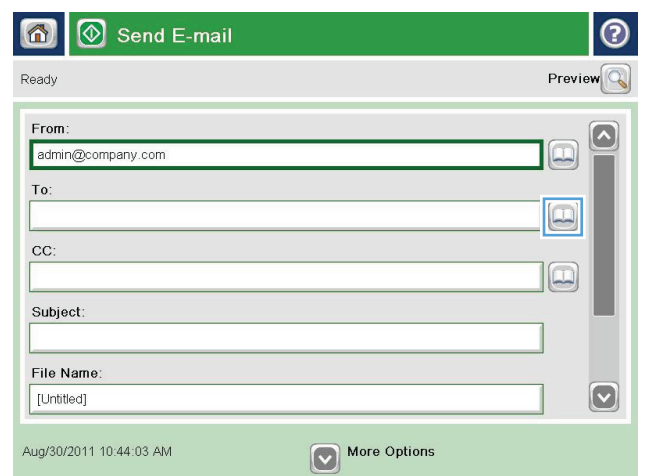
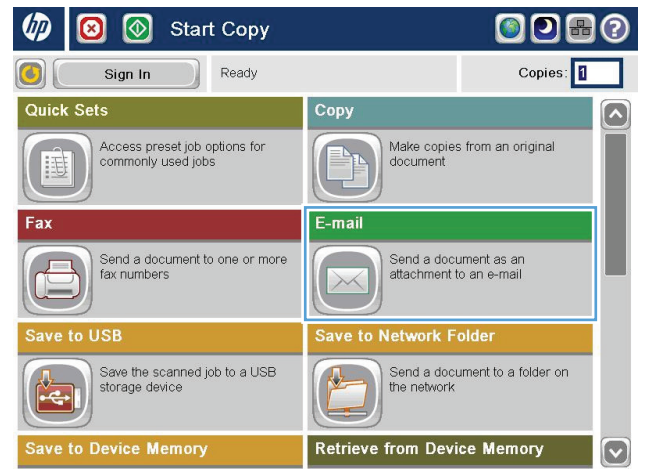
- From the drop-down list, select the address book view that you want to use.



5. Select a name from the list of contacts, and then touch the right arrow Address Book  button to add the name to the recipients list.

Repeat this step for each recipient, and then touch the **OK** button.

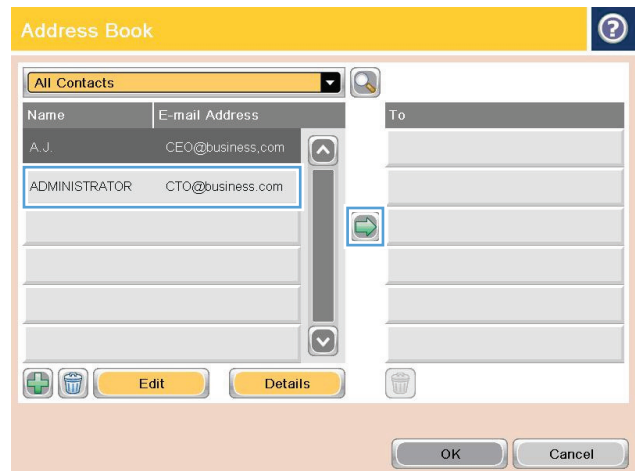

6. Touch the Start  button to begin sending.

**NOTE:** You can preview the image at any time by touching the **Preview** button in the upper-right corner of the screen. For more information about this feature, touch the **Help**  button on the preview screen.

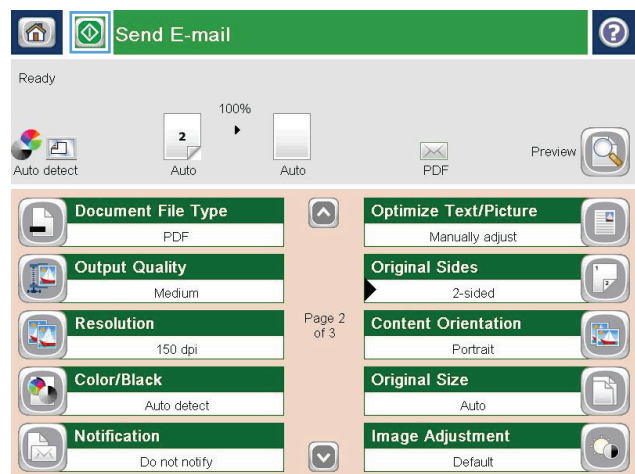



## Scan a photo

1. Lift the scanner lid.

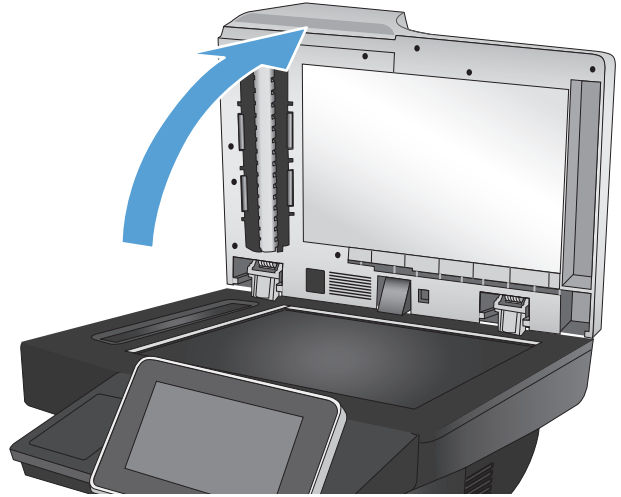

2. Place the photo on the scanner glass with the picture-side down and the upper-left corner of the photo in the upper-left corner of the glass.

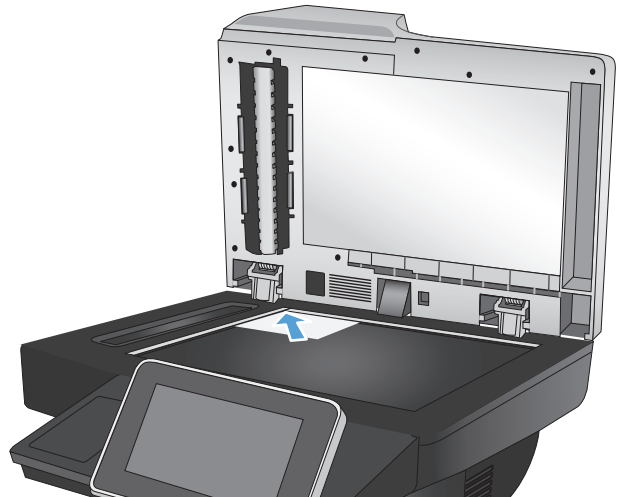

3. Gently close the scanner lid.

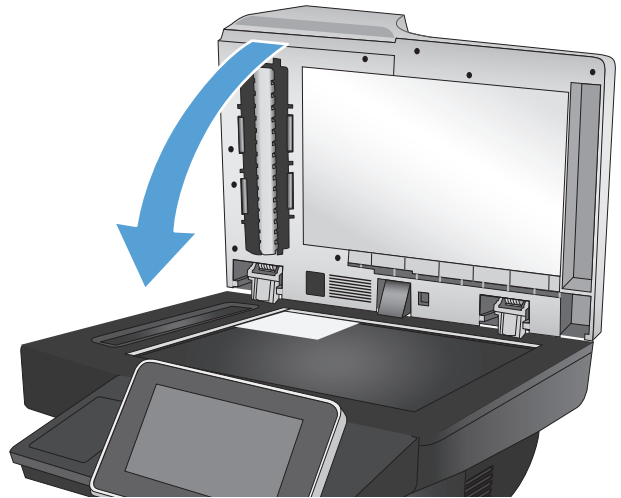

4. From the Home screen on the product control panel, touch one of the buttons for the scan/send features:
  - Save to Network Folder
  - Save to Device Memory
  - Save to USB
5. Select an existing folder, or touch the **New Folder** button to create a new folder.
6. Enter the name for the file in the **File Name:** field.
7. Touch the **More Options** button at the bottom of the screen.
8. Touch the **Optimize Text/Picture** button.
9. Select the **Photograph** option, and then touch the **OK** button.
10. Touch the Start  button.



**NOTE:** These settings are temporary. After you have finished the job, the product returns to the default settings.

---

---

# 8 Fax

- [Configure required fax settings](#)
- [Configure fax dialing settings](#)
- [Configure general fax send settings](#)
- [Configure fax billing codes](#)
- [Configure default options for fax send jobs](#)
- [Configure fax receive settings](#)
- [Use a fax printing schedule](#)
- [Block incoming faxes](#)
- [Configure default options for fax receive jobs](#)
- [Fax archiving and forwarding](#)
- [Create a speed dial list](#)
- [Add a number to an existing speed dial list](#)
- [Delete a speed dial list](#)
- [Delete a single number from a speed dial list](#)
- [Send a fax by entering numbers manually](#)
- [Send a fax by using a speed dial](#)
- [Search a speed-dial list by name](#)
- [Send a fax by using fax address book numbers](#)
- [Search the fax address book](#)
- [Cancel a fax](#)
- [Fax reports](#)

# Configure required fax settings

You must configure certain settings before you can use the fax feature. If these settings are not configured, the fax icon is unavailable. These settings include:

- [Country/region](#)
- [Date/Time](#)
- [Company Name](#)
- [Fax Number](#)
- [Dialing Prefix](#) (optional)

This information is used in the fax header, which is for printing on all outgoing faxes.

---

 **NOTE:** When first installed, the fax accessory might read some of these settings from the product; therefore, a value might already be set. Check the values to verify that they are correct.

 **NOTE:** In the U.S. and many other countries/regions, setting the date, time, country/region, phone number, and company name is a legal requirement for fax.

---

## Fax Setup Wizard

The Fax Setup Wizard guides you through a step-by-step procedure to configure fax settings that are required to use the fax feature. If the settings are not configured, the fax feature is disabled.

The first time the product is turned on with a fax accessory installed, access the Fax Setup Wizard by following these steps:

1. From the Home screen on the product control panel, touch the [Initial Setup](#) button.
2. Touch the [Fax Setup Wizard](#) menu.
3. Follow the steps in the Fax Setup Wizard to configure the required settings.
4. When the Fax Setup Wizard finishes, the option to hide the [Initial Setup](#) button appears on the Home screen.

Access the Fax Setup Wizard *after* initial setup through the control panel by following these steps:

1. From the Home screen on the product control panel, scroll to and touch the [Administration](#) button.
2. Open the following menus:
  - [Fax Settings](#)
  - [Fax Send Settings](#)
  - [Fax Send Setup](#)
  - [Fax Setup Wizard](#)
3. Follow the steps in the Fax Setup Wizard to configure the required settings. Fax setup is complete.

 **NOTE:** The settings configured using the Fax Setup Wizard on the control panel override any settings made in the HP Embedded Web Server.

 **NOTE:** If the Fax Settings menu does not appear in the menu listing, LAN or internet fax might be enabled. When LAN or internet fax is enabled, the analog fax accessory is disabled and the Fax Settings menu does not display. Only one fax feature, either LAN fax, analog fax, or internet fax, can be enabled at a time. If you want to use analog fax when LAN fax is enabled, use the HP MFP Digital Sending Software Configuration Utility or the HP Embedded Web Server to disable LAN fax.

## Set or verify the date and time

The date and time setting for the fax accessory is the same value as the product date and time setting. Use the Fax Setup Wizard to provide this information, or follow these steps:

1. From the Home screen on the product control panel, scroll to and touch the [Administration](#) button.
2. Open the following menus:
  - [General Settings](#)
  - [Date/Time Settings](#)
  - [Date/Time](#)
3. Touch the correct [Time Zone](#) setting for your locale.
4. Touch the [Month](#) drop-down menu and select a month.
5. Touch the boxes next to the [Date](#) drop-down menu to enter the day and year from the keypad.
6. Touch the boxes below the [Time](#) heading to enter the hour and minutes from the keypad, and then touch the [AM](#) or [PM](#) button.
7. Touch the [Adjust for Daylight Savings](#) feature, if necessary.
8. Touch the [Save](#) button to save the settings.

## Set or verify the date/time format

The date and time format setting for the fax accessory is in the same format as the product date and time setting. Use the Fax Setup Wizard to provide this information, or follow these steps:

1. From the Home screen on the product control panel, scroll to and touch the [Administration](#) button.
2. Open the following menus:
  - [General Settings](#)
  - [Date/Time Settings](#)
  - [Date/Time Format](#)
3. Touch a [Date Format](#) option.

4. Touch a [Time Format](#) option.
5. Touch the [Save](#) button to save the settings.

# Configure fax dialing settings

1. From the Home screen on the product control panel, scroll to and touch the [Administration](#) button.
2. Open the following menus:
  - [Fax Settings](#)
  - [Fax Send Settings](#)
  - [Fax Send Setup](#)
  - [Fax Dialing Settings](#)

Configure any of the following settings:

Menu item	Description
<a href="#">Fax Dial Volume</a>	Use the <a href="#">Fax Dial Volume</a> setting to control the product's dialing volume level when sending faxes.
<a href="#">Dialing Mode</a>	The <a href="#">Dialing Mode</a> setting sets the type of dialing that is used: either tone (touch-tone phones) or pulse (rotary-dial phones).
<a href="#">Fax Send Speed</a>	The <a href="#">Fax Send Speed</a> setting sets the modem bit rate (measured in bits per second) of the Analog Fax modem while sending a fax. <ul style="list-style-type: none"><li>• <a href="#">Fast</a> (default) — v.34/max 33,600 bps</li><li>• <a href="#">Medium</a> — v.17/max 14,600 bps</li><li>• <a href="#">Slow</a> — v.29/max 9,600 bps</li></ul>
<a href="#">Redial Interval</a>	The <a href="#">Redial Interval</a> setting selects the number of minutes between retries if the number dialed is busy or not answering, or if an error occurs.  <b>NOTE:</b> You might observe a redial message on the control panel when both the <a href="#">Redial On Busy</a> and <a href="#">Redial On No Answer</a> settings are set to off. This occurs when the fax accessory dials a number, establishes a connection, and then loses the connection. As a result of this error condition, the fax accessory performs three automatic redial attempts regardless of the redial settings. During this redial operation, a message displays on the control panel to indicate that a redial is in progress.
<a href="#">Redial on error</a>	The <a href="#">Redial on error</a> feature sets the number of times a fax number will be redialed when an error occurs during a fax transmission.
<a href="#">Redial On Busy</a>	The <a href="#">Redial On Busy</a> setting selects the number of times (0 through 9) the fax accessory redials a number when the number is busy. The interval between retries is set by the Redial Interval setting.
<a href="#">Redial On No Answer</a>	The <a href="#">Redial On No Answer</a> setting selects the number of times the fax accessory redials if the number dialed does not answer. The number of retries is either 0 to 1 (used in the U.S.) or 0 to 2, depending on the country/region setting. The interval between retries is set by the redial interval setting.

<b>Menu item</b>	<b>Description</b>
Detect Dial Tone	The <a href="#">Detect Dial Tone</a> setting determines whether the fax checks for a dial tone before sending a fax.
Dialing Prefix	The <a href="#">Dialing Prefix</a> setting allows you to enter a prefix number (such as a "9" to access an outside line) when dialing. This prefix number is automatically added to all phone numbers when dialed.



# Configure general fax send settings

1. From the Home screen on the product control panel, scroll to and touch the [Administration](#) button.
2. Open the following menus:
  - [Fax Settings](#)
  - [Fax Send Settings](#)
  - [Fax Send Setup](#)
  - [General Fax Send Settings](#)

Configure any of the following settings:

Menu item	Description
<a href="#">Fax Number Confirmation</a>	When the <a href="#">Fax Number Confirmation</a> feature is enabled, the fax number must be entered twice to ensure that it was entered correctly. The feature is disabled by default.
<a href="#">PC Fax Send</a>	Use the <a href="#">PC Fax Send</a> feature to send faxes from a PC. This feature is enabled by default.
<a href="#">Fax Header</a>	Use the <a href="#">Fax Header</a> feature to control whether the header is appended to the top, and content is shifted down, or if the header is overlaid on top of the previous header.
<a href="#">JBIG Compression</a>	<p>Enabling the <a href="#">JBIG Compression</a> feature can reduce phone-call charges by reducing fax transmission time and might be the preferred setting. However, using the <a href="#">JBIG Compression</a> feature might cause compatibility problems when communicating with some older fax machines, in which case you might need to disable it.</p> <p><b>NOTE:</b> The <a href="#">JBIG Compression</a> feature works only when both the sending and receiving machines have this setting.</p>
<a href="#">Error Correction Mode</a>	<p>Normally, the fax accessory monitors the signals on the telephone line while it is sending or receiving a fax. If the fax accessory detects an error during the transmission and the <a href="#">Error Correction Mode</a> setting is on, the fax accessory can request that the error portion of the fax be sent again.</p> <p>The <a href="#">Error Correction Mode</a> feature is enabled by default. You should turn it off only if you are having trouble sending or receiving a fax and if you are willing to accept the errors in the transmission and a probable quality reduction in the image. Turning off the setting might be useful when you are trying to send a fax overseas or receive one from overseas, or if you are using a satellite telephone connection.</p> <p><b>NOTE:</b> Some VoIP providers might suggest turning off the <a href="#">Error Correction Mode</a> setting. However, this is not usually necessary.</p>

# Configure fax billing codes

The billing-code setting, when enabled, prompts the user to enter a number when sending a fax. This number is placed in the billing-code report. To view the billing-code report, either print the report or query it by using an application.

Billing codes are disabled by default. Follow these steps to enable billing codes:

1. From the Home screen on the product control panel, scroll to and touch the [Administration](#) button.
2. Open the following menus:
  - [Fax Settings](#)
  - [Fax Send Settings](#)
  - [Fax Send Setup](#)
  - [Billing Codes](#)
3. Touch the [Enable Billing Codes](#) feature to enable billing codes.



---

**NOTE:** To disable billing codes, deselect the [Enable Billing Codes](#) feature, touch the [Save](#) button, and then skip the remaining steps.

To allow users to edit billing codes, select the [Allow users to edit billing codes](#) box.

---

4. Touch the [Default Billing Code](#) field to open the keyboard.
5. Enter the billing code and then touch the [OK](#) button.
6. Touch the [Minimum Length](#) field to open the keypad.
7. Type the minimum number of digits you want in the billing code, and then touch the [OK](#) button.
8. Touch the [Save](#) button.

# Configure default options for fax send jobs

 **NOTE:** Default job option settings are shared across all fax methods; analog, LAN, and internet fax.

1. From the Home screen on the product control panel, scroll to and touch the [Administration](#) button.
2. Open the following menus:
  - [Fax Settings](#)
  - [Fax Send Settings](#)
  - [Default Job Options](#)

Configure any of the following settings:

Menu item	Description
<a href="#">Resolution</a>	<p>The outgoing fax resolution setting determines the maximum resolution supported by the receiving fax. The fax accessory uses the highest possible resolution common to the sending and receiving fax machines (as limited by this setting).</p> <p><b>NOTE:</b> Faxes wider than 21.25 cm (8.5 inches) are automatically sent by using standard or fine resolution, to reduce phone time.</p> <p><b>NOTE:</b> The higher the resolution, the longer the transmission time required.</p> <p><b>NOTE:</b> LAN fax resolution settings vary by vendor and might differ from the settings listed.</p>
<a href="#">Original Sides</a>	Use the <a href="#">Original Sides</a> feature to select <a href="#">1-sided</a> or <a href="#">2-sided</a> originals.
<a href="#">Notification</a>	Use the <a href="#">Notification</a> feature to select when and how you are notified of the status of an outgoing fax. This setting applies to the current fax only. To change the setting permanently, change the default setting.
<a href="#">Content Orientation</a>	Use the <a href="#">Content Orientation</a> feature to set how the fax content is oriented on the page. For 1-sided pages, choose Portrait (short-edge on top, default setting) or Landscape (long-edge on top). For 2-sided pages, choose Book-style (short-edge on top) or Flip-style (long-edge on top).
<a href="#">Original Size</a>	Use the <a href="#">Original Size</a> feature to match your fax content to the size of the original document.
<a href="#">Image Adjustment</a>	<p>Use the <a href="#">Image Adjustment</a> feature to adjust the <a href="#">Darkness</a>, <a href="#">Contrast</a>, <a href="#">Background Cleanup</a>, or <a href="#">Sharpness</a> settings.</p> <p>In some cases, a gray background on the document causes the fax to transmit more slowly.</p> <p><b>NOTE:</b> Touch the <a href="#">Default</a> button to reset the sharpness setting to the factory setting.</p>
<a href="#">Optimize Text/Picture</a>	Use the <a href="#">Optimize Text/Picture</a> feature to produce fax output that best matches the original. Sending graphics and photos in text mode results in lower quality images.
<a href="#">Job Build</a>	Use the <a href="#">Job Build</a> feature to combine multiple originals into a single fax job.
<a href="#">Blank Page Suppression</a>	Use the <a href="#">Blank Page Suppression</a> feature to prevent blank pages in a fax from being printed.

# Configure fax receive settings

1. From the Home screen on the product control panel, scroll to and touch the [Administration](#) button.
2. Open the following menus:
  - [Fax Settings](#)
  - [Fax Receive Settings](#)
  - [Fax Receive Setup](#)

Configure any of the following settings:

Menu item	Description
<a href="#">Ringer Volume</a>	Touch the <a href="#">Ringer Volume</a> drop-down menu and adjust the ringer volume settings.
<a href="#">Rings To Answer</a>	<p>The <a href="#">Rings To Answer</a> setting determines the number of times the phone rings before the call is answered by the fax accessory.</p> <p><b>NOTE:</b> The default range for the available options for the <a href="#">Rings To Answer</a> setting is country/region-specific. The range of possible <a href="#">Rings To Answer</a> options is limited by country/region.</p> <p>If you experience problems with the fax accessory answering, and the <a href="#">Rings To Answer</a> setting is <b>1</b>, try increasing it to <b>2</b>.</p>
<a href="#">Fax Receive Speed</a>	<p>Touch the <a href="#">Fax Receive Speed</a> drop down menu and select one of the following options:</p> <ul style="list-style-type: none"><li>• <a href="#">Fast</a> (default) — v.34/max 33,600 bps</li><li>• <a href="#">Medium</a> — v.17/max 14,600 bps</li><li>• <a href="#">Slow</a> — v.29/max 9,600 bps</li></ul>
<a href="#">Ring Interval</a>	Touch the box beneath the <a href="#">Ring Interval</a> heading to open the keypad. Enter a value for the ring interval on the keypad, and then touch the <a href="#">OK</a> button. The default setting for ring interval is 600 ms.
<a href="#">Ring Frequency</a>	Touch the box beneath the <a href="#">Ring Frequency</a> heading to open the keypad. Enter a value for the ring frequency on the keypad, and then touch the <a href="#">OK</a> button. The default setting for ring frequency is 68 Hz, which detects rings up to 68 Hz.

# Use a fax printing schedule



---

**NOTE:** Before enabling a fax-printing schedule, a schedule must be created.

---

1. From the Home screen on the product control panel, scroll to and touch the [Administration](#) button.
2. Open the following menus:
  - [Fax Settings](#)
  - [Fax Receive Settings](#)
  - [Fax Printing Schedule](#)
3. Touch the [Use Fax Printing Schedule](#) option.
4. Touch the [Schedule](#) button.
5. Touch the [Fax Printing Mode](#) button.
6. Touch the green plus sign to open the [Schedule a Weekly Fax Event](#) screen.
7. Select an option under the [Event Type](#) heading:
  - [Print incoming faxes](#)
  - [Store incoming faxes](#)
8. Touch the [Time](#) fields to open the keypad and then enter the hour and minute values when incoming faxes will be printed or stored.
9. Touch the [Event Days](#) buttons for the days to apply the fax printing schedule.
10. Touch the [OK](#) button.
11. Touch the [Save](#) button to save the fax printing schedule.
12. Touch the [Save](#) button to enable fax printing schedule.



---

**NOTE:** Only one fax printing schedule can be applied per day.

---

# Block incoming faxes

Use the fax block list setting to create a list of blocked phone numbers. When a fax is received from a blocked phone number, the fax is not printed and is immediately deleted from memory.

## Create a blocked-fax list

1. From the Home screen on the product control panel, scroll to and touch the [Administration](#) button.
2. Open the following menus:
  - [Fax Settings](#)
  - [Fax Receive Settings](#)
  - [Blocked Fax Numbers](#)
3. Touch the [Fax Number to Block](#) field to display the keyboard.
4. Type a number and then touch the [OK](#) button.
5. Touch the green arrow to move the number to the [Blocked Fax Numbers](#) list.



**NOTE:** To add additional blocked fax numbers, repeat steps 3 through 5.

6. Touch the [Save](#) button to save the blocked fax numbers list.

## Delete numbers from the blocked-fax list

1. From the Home screen on the product control panel, scroll to and touch the [Administration](#) button.
2. Open the following menus:
  - [Fax Settings](#)
  - [Fax Receive Settings](#)
  - [Blocked Fax Numbers](#)
3. Touch the number to be deleted from the [Blocked Fax Numbers](#) list, touch the [Delete](#) button, and then touch the [Save](#) button.
4. Touch the [OK](#) button to confirm the deletion of the number.
5. Repeat steps 3 and 4 to delete more numbers from the [Blocked Fax Numbers](#) list, or touch the [Delete All](#) button, and then touch the [Save](#) button, to delete all numbers from the [Blocked Fax Numbers](#) list at once.

# Configure default options for fax receive jobs



**NOTE:** Default job option settings are shared across all fax methods; analog, LAN, and internet fax.

1. From the Home screen on the product control panel, scroll to and touch the [Administration](#) button.
2. Open the following menus:
  - [Fax Settings](#)
  - [Fax Receive Settings](#)
  - [Default Job Options](#)

Configure any of the following settings:

Menu item	Description
<a href="#">Notification</a>	The <a href="#">Notification</a> setting controls when the fax call report is printed for incoming faxes.
<a href="#">Stamp Received Faxes</a>	The <a href="#">Stamp Received Faxes</a> setting enables or disables stamping incoming faxes. The stamp prints the date, time, phone number, and page number on each incoming page.
<a href="#">Fit to Page</a>	When selecting a page size to print a fax, the product determines the closest page size that matches the intended size from sizes available in the product. If the fit-to-page setting is enabled and the received image is larger than that page size, the product attempts to scale the image to fit the page. If this setting is disabled, an incoming image larger than the page splits across pages.
<a href="#">Paper Selection</a>	Use the <a href="#">Paper Selection</a> feature to specify which tray to use for printing faxes.
<a href="#">Sides</a>	Use the <a href="#">Sides</a> feature to specify 1-sided or 2-sided output for faxes.

# Fax archiving and forwarding

Use the fax archive feature to save archival copies of all incoming faxes, all outgoing faxes, or both, to a specified email address.

Use the fax forwarding feature to forward all received faxes, all outgoing faxes, or both, to another fax number. When fax forwarding is enabled, the receiving product prints the fax and also forwards the fax to the fax forward number.



**NOTE:** To use the [Archive to Email Address](#) feature, the SMTP server must be configured, and responding. Use the HP Embedded Web Server to configure the SMTP server. The **E-mail Setup** settings are on the **Scan/Digital Send** tab.

## Enable fax archiving

1. From the Home screen on the product control panel, scroll to and touch the [Administration](#) button.
2. Open the following menus:
  - [Fax Settings](#)
  - [Fax Archive and Forwarding](#)
3. Touch the [Enable Fax Archiving](#) box.
4. Select one of the following options from the [Type of Fax Job to Archive](#) drop-down menu:
  - [Send and receive](#) (default)
  - [Send only](#)
  - [Receive only](#)
5. Touch the [Fax Archiving E-mail Address](#) field to open the keypad.
6. Type the email address where faxes will be forwarded, and then touch the [OK](#) button.
7. Touch the [Save](#) button.

## Enable fax forwarding

1. From the Home screen on the product control panel, scroll to and touch the [Administration](#) button.
2. Open the following menus:
  - [Fax Settings](#)
  - [Fax Archive and Forwarding](#)
3. Touch the [Enable Fax Forwarding](#) box.



4. Select one of the following options from the [Type of Fax Job to Forward](#) drop-down menu:
  - [Send and receive](#)
  - [Send only](#)
  - [Receive only](#) (default)
5. Touch the [Fax Forwarding Number](#) field to open the keypad.
6. Type the number where faxes will be forwarded, and then touch the [OK](#) button.
7. Touch the [Save](#) button.

# Create a speed dial list

1. From the Home screen on the product control panel, touch the **Fax** button.

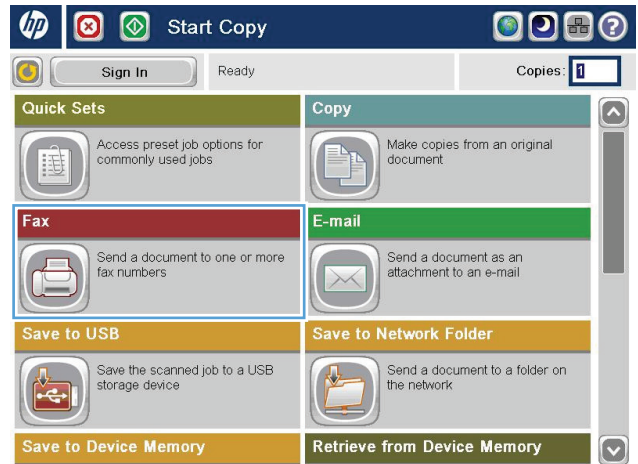

2. Touch the **Speed Dials** button to display the **Speed Dials** screen.

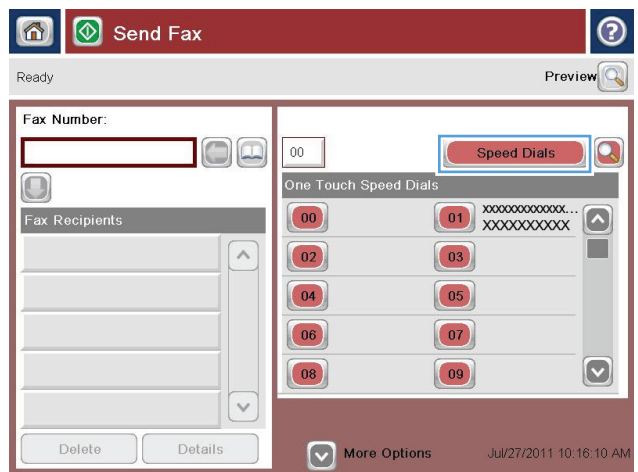

3. Touch one of the unassigned **One Touch Speed Dials** numbers.

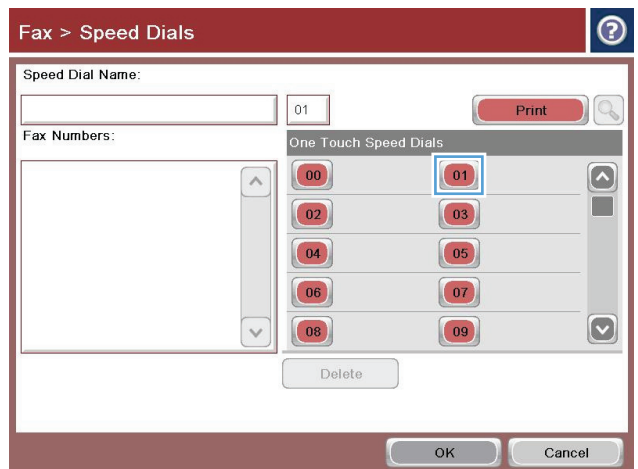

4. Touch the **Speed Dial Name** field to display the keyboard.

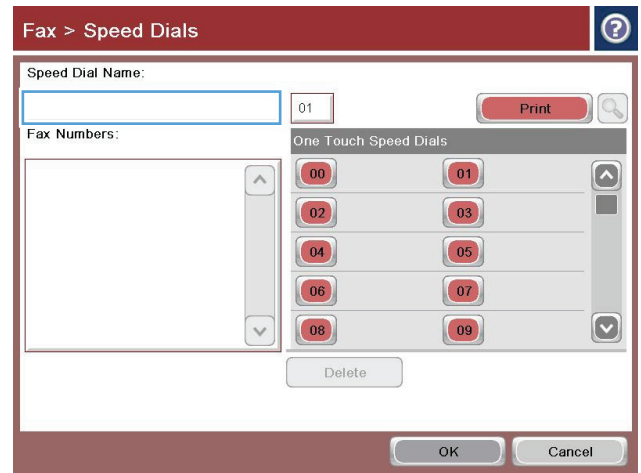

5. Type a name for the speed dial.

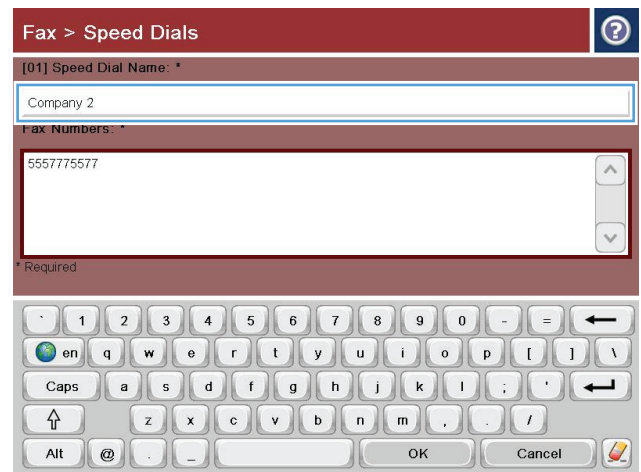

6. Type a fax number for the speed dial.

**NOTE:** To enter additional fax numbers for a speed dial, touch the screen to the right of the last digit of the previously entered fax number. When the cursor appears, touch the enter key to move the cursor to the next line. Repeat this step to enter all the numbers for the speed dial.

Touch the **OK** button.

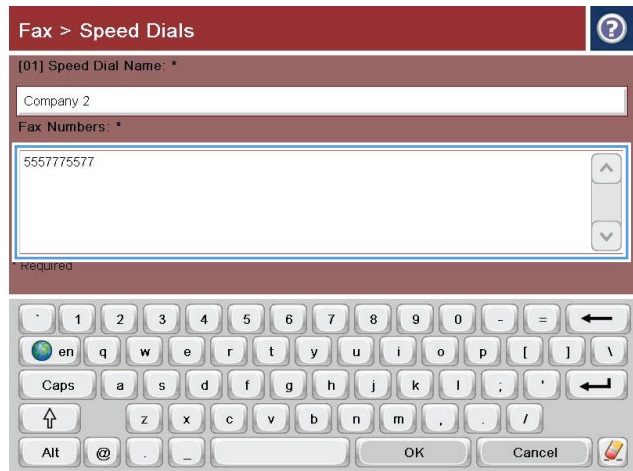

7. The name and fax number (or numbers) display next to the selected **One Touch Speed Dials** number.

Touch the **OK** button to return to the **Fax** screen.

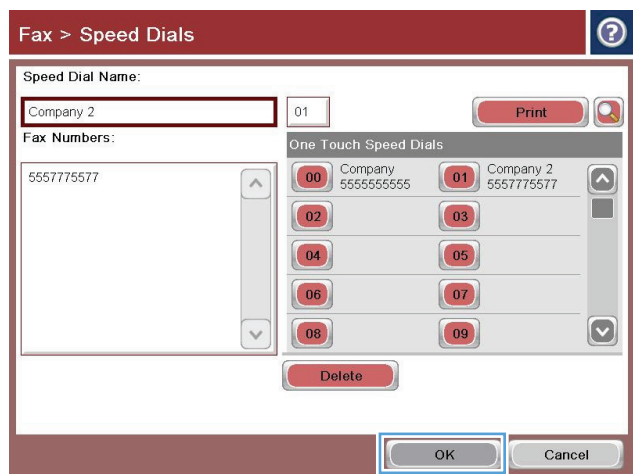

## Add a number to an existing speed dial list

1. From the Home screen on the product control panel, scroll to and touch the **Fax** button.
2. Touch the **Speed Dials** button to display the **Speed Dials** screen.
3. Touch the **One Touch Speed Dials** number of the list to be edited.
4. Touch the down arrow on the **Speed Dial Name** box to open the drop-down menu.
5. Touch the **Fax Numbers** item.
6. To add a fax number for a speed dial name, touch the screen to the right of the last digit of the last fax number in the list. When the cursor appears, touch the enter key to move the cursor to the next line and then type the fax number.
7. Touch the **OK** button to return to the **Speed Dials** screen.
8. Touch the **OK** button to return to the **Fax** screen.

## Delete a speed dial list

1. From the Home screen on the product control panel, scroll to and touch the **Fax** button.
2. Touch the **Speed Dials** button to display the **Speed Dials** screen.
3. Touch the **One Touch Speed Dials** number of the list to be deleted.
4. Touch the **Delete** button.
5. Touch the **Yes** button to confirm the deletion of the speed dial list and to return to the **Fax** screen.

## Delete a single number from a speed dial list

1. From the Home screen on the product control panel, scroll to and touch the **Fax** button.
2. Touch the **Speed Dials** button to display the **Speed Dials** screen.
3. Touch the **One Touch Speed Dials** number of the list to open the keyboard.
4. Touch the down arrow on the **Speed Dial Name** box to open the drop-down menu and then touch the **Fax Numbers** option.
5. Scroll through the list of fax numbers and touch the screen to the right of last digit of the fax number to be deleted. Use the backspace key to delete the fax number.
6. Touch the **OK** button to return to the **Speed Dials** screen.
7. Touch the **OK** button to return to the **Fax** screen.

# Send a fax by entering numbers manually

1. Place the document face-down on the scanner glass, or place it face-up in the document feeder and adjust the paper guides to fit the size of the document.

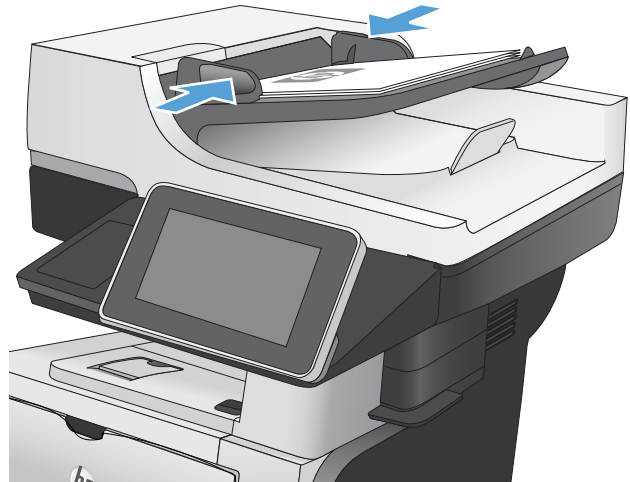

2. From the Home screen on the product control panel, touch the **Fax** button. You might be prompted to type a user name and password.

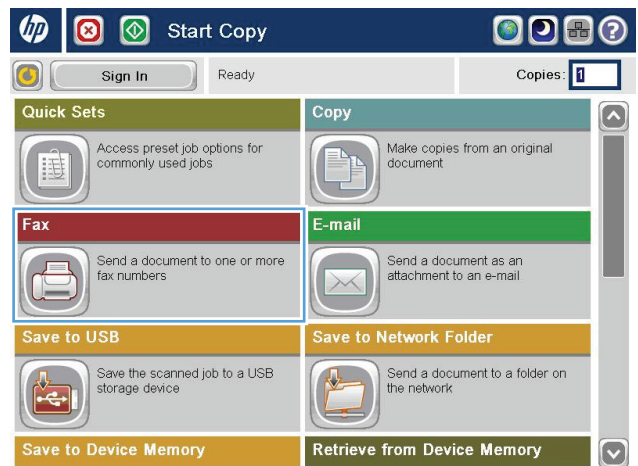

3. Touch the **More Options** button. Verify that the settings match those of your original. When all settings are completed, touch the up arrow to scroll to the main **Fax** screen.

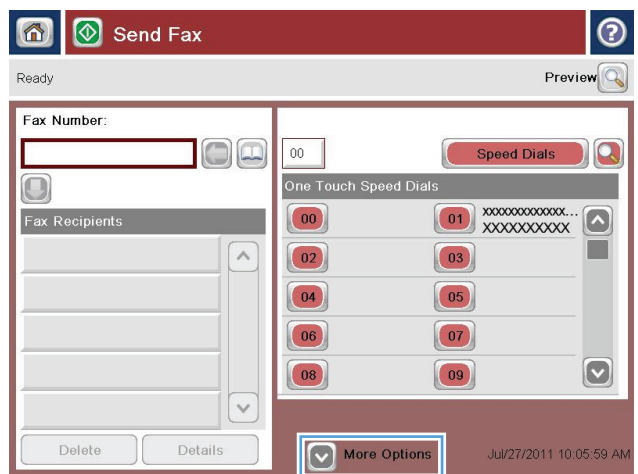



4. Touch the **Fax Number** field to open the keypad.

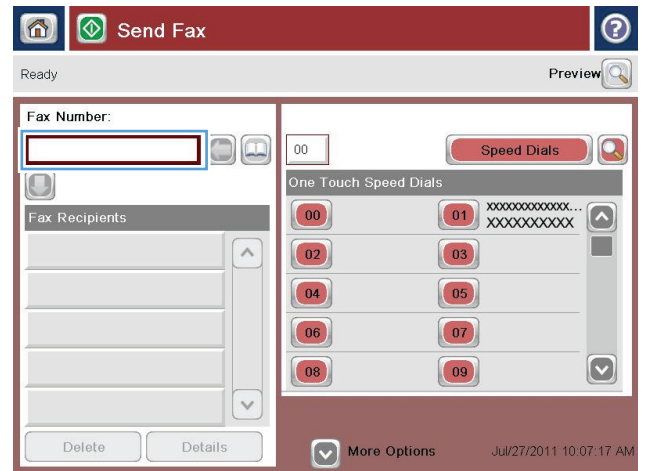

5. Enter a phone number and then touch the **OK** button.

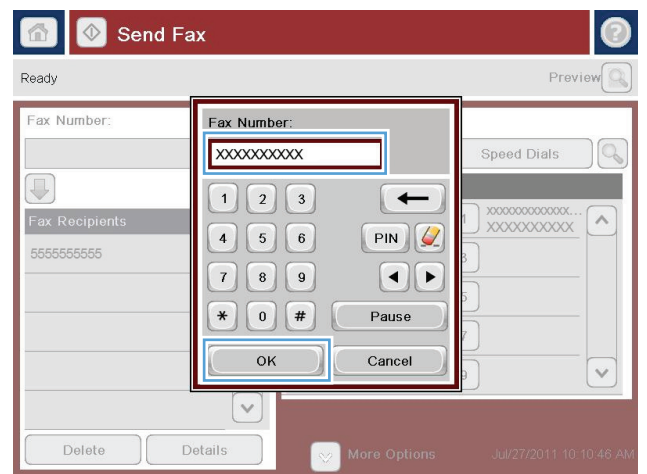

6. Touch the **Start** button to send the fax.

**NOTE:** You can preview the image at any time by touching the **Preview** button in the upper-right corner of the screen. For more information about this feature, touch the **Help** button on the preview screen.

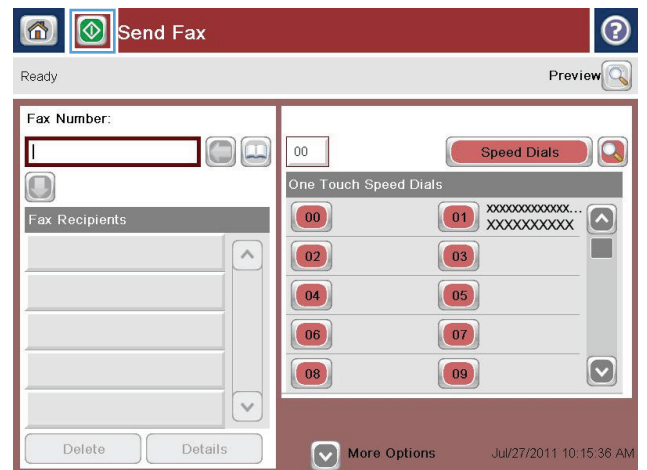

## Send a fax by using a speed dial

1. Place the document face-down on the scanner glass, or place it face-up in the document feeder and adjust the paper guides to fit the size of the document.

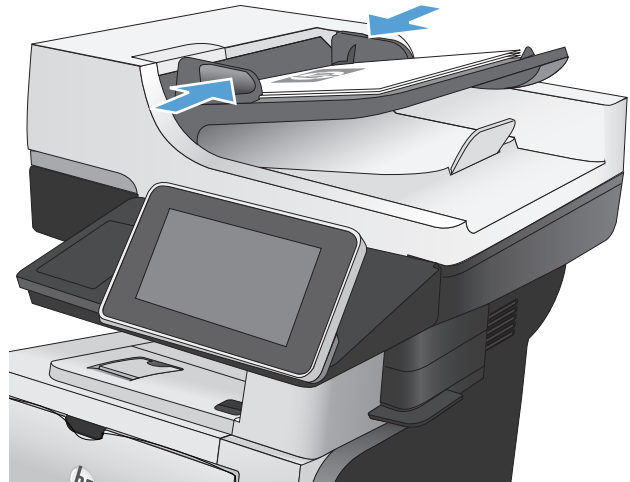

2. From the Home screen on the product control panel, touch the **Fax** button.

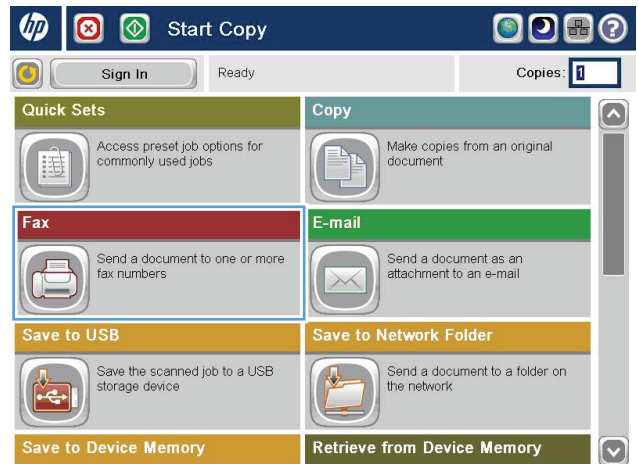

3. Touch the number button for the speed dial name you want to use. The speed dial name appears in the **Fax Recipients** section of the **Fax** screen.

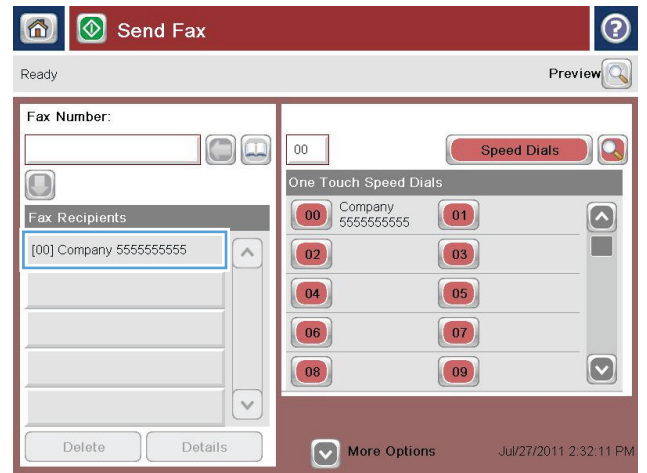

4. Touch the Start button to send the fax.  
**NOTE:** You can preview the image at any time by touching the **Preview** button in the upper-right corner of the screen. For more information about this feature, touch the **Help** button on the preview screen.

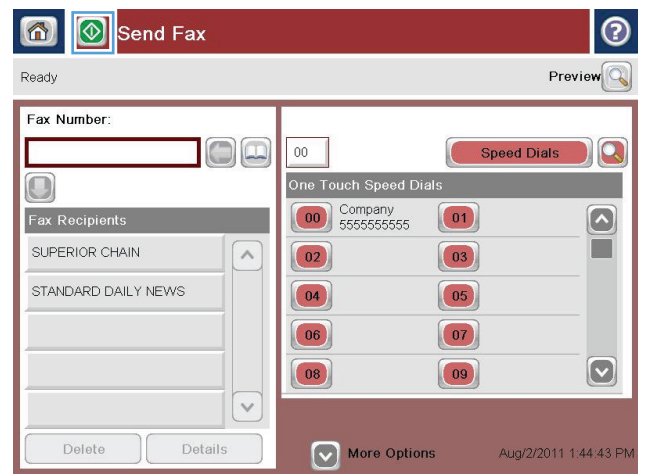

## Search a speed-dial list by name



**NOTE:** If you do not know the unique name of the speed dial, type a letter to select any portion of the list. For example, to view speed-dial names that begin with the letter N, type the letter N. If no matching entries exist, a message appears before the search shows the entry that is closest to the letter N.

1. From the Home screen on the product control panel, touch the **Fax** button.
2. Touch the search button. This button looks like a magnifying glass and is located to the right of the **Speed Dials** button.
3. Type the first letters of the speed dial name to search for. As matches are found, the list at the top of the search screen is populated. If necessary, scroll to see all the entries, or type more letters to narrow the search.
4. Select the appropriate name from the list and touch the **OK** button. The speed-dial list on the main fax screen shows the selected entry within the list of numbers.
5. Touch a speed dial number to add it to the recipients list.
6. Select or search for additional names as needed.

# Send a fax by using fax address book numbers

The fax address book feature allows you to store fax numbers on the product.

Your Microsoft® Exchange contact list might also be enabled on the product to appear in the fax address book.

1. From the Home screen on the product control panel, touch the **Fax** button.

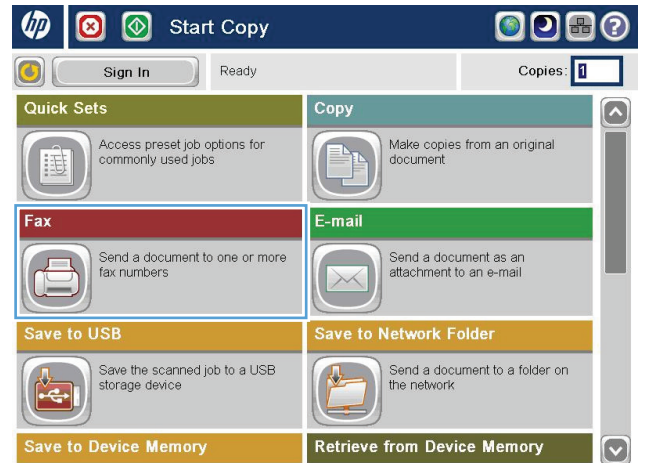

2. Touch the **Address Book** icon to display the **Address Book** screen.

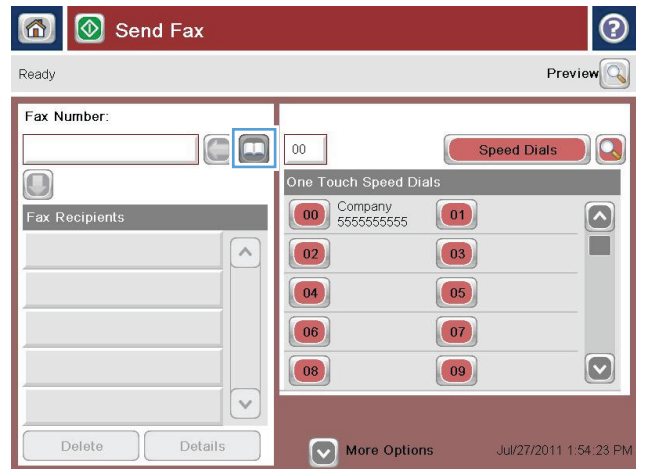

3. Select a fax address book source from the drop-down menu.

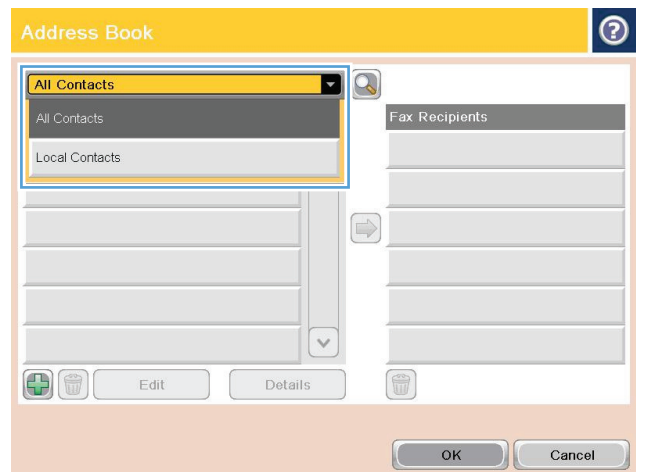

4. Touch the names to highlight and then touch the right arrow icon to move the highlighted names to the Fax Recipients section.

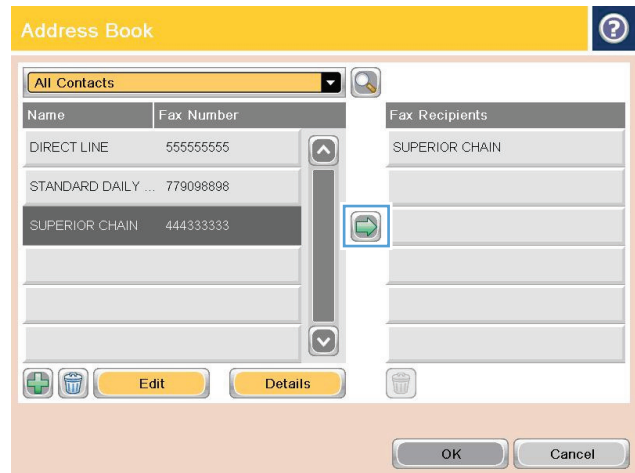

5. Touch the OK button to return to the Fax screen.

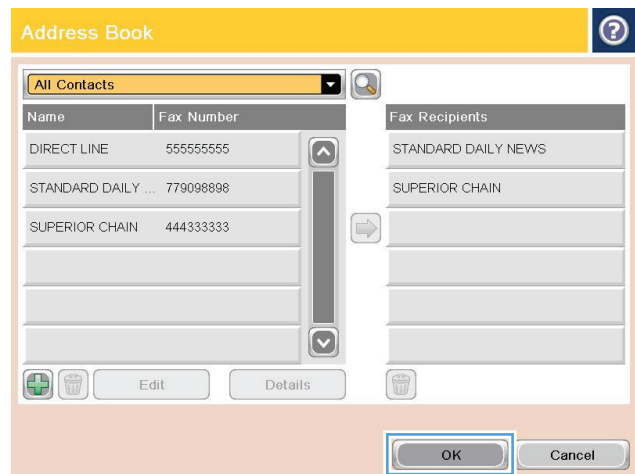

6. Touch the Start button to send the fax.

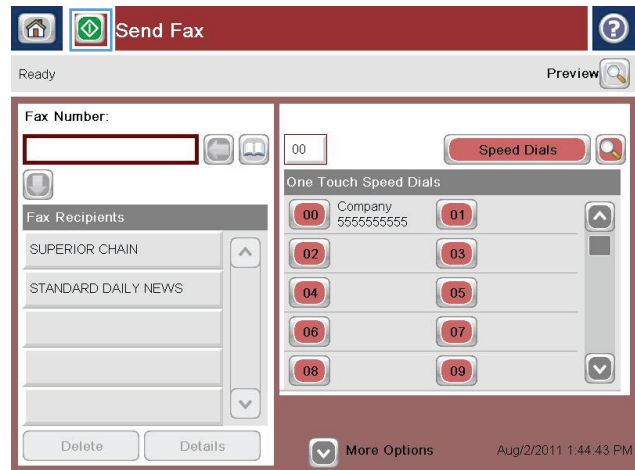

## Search the fax address book

Use the fax address book search feature to complete a name search of the address book.

1. From the Home screen on the product control panel, touch the [Fax](#) button.
2. Touch the Address Book  button.
3. Select the [All Contacts](#) or [Local Contacts](#) option in the drop-down menu at the top of the fax address book screen.
4. Touch the Search icon (magnifying glass) next to the drop-down menu.
5. On the keyboard, enter the first letter or letters of the name; matching recipients display on the screen. Type more letters to further refine the search. Select a name, and then touch the [OK](#) button.
6. Touch the right arrow to transfer the selected name to the [Fax Recipients](#) list.
7. Touch the [OK](#) button to return to the [Send Fax](#) screen.

# Cancel a fax

To cancel a current fax job, touch the **Cancel Job** button on the fax status screen.

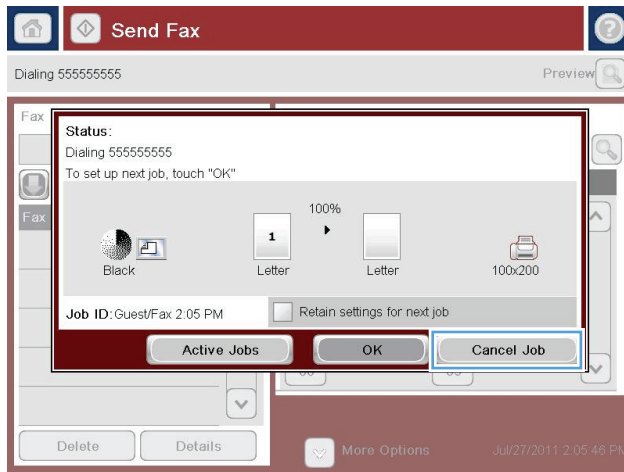



# Fax reports

The following sections list the fax reports available on this product. These reports can be printed or viewed on the product control panel.

## The following fax reports are available on this product:

- Fax Activity Log
- Billing Codes Report
- Blocked Fax List
- Speed Dial List
- Fax Call Report

## Use the following steps to print or view a fax report:

1. From the Home screen on the product control panel, scroll to and touch the [Administration](#) button.
2. Open the following menus:
  - [Reports](#)
  - [Fax Reports](#)
3. Select the log or report to print or view.
4. Touch the [Print](#) or [View](#) button.

## Fax activity log

The fax activity log includes the following information.

- The fax header information configured on the product.
- The job number of each fax job.
- Date and time of faxes received, sent, or failed to send.
- The type of fax job; send or receive.
- Identification of the sender (phone number, if available)
- Duration (off-hook time)
- Number of pages
- Result (successfully sent, pending, or failed to send which includes error type and code)

The database stores the most recent 500 fax entries. The database fax entries include any fax session as an entry. For example, a fax session could be a sent fax, received fax, or firmware upgrades. Depending on the activity, there might be fewer than 500 entries in the report.

If you want to use the log for record keeping purposes, print the log periodically and then clear it.

To clear the fax activity log, complete the following steps.

1. On the control panel, touch the [Administration](#) icon.
2. Open the following menus:
  - [Fax Settings](#)
  - [Clear fax activity log](#)
3. Touch the [Clear](#) button to clear the fax activity log.

## Billing code report

The billing code report is a list of the most recent 500 faxes that were successfully sent, listed by billing code. The following information is provided in this report.

- Billing code number
- Date and time of all faxes that were successfully sent
- Identification number
- Duration (off hook time)
- Number of pages sent
- Result (success)

The database stores the most recent 500 faxes. If you want to use the report for record-keeping purposes, print the report periodically and then clear it.

## Blocked fax list report

The blocked fax list report contains the list of fax numbers that the product has been configured to not receive faxes from.

## Speed dial list report

A speed dial list report lists the fax numbers assigned to speed dial names.

## Fax call report

The fax call report is a brief report that indicates the status of the last fax that was sent or received.

---

## 9 Manage the product

- [Configure IP network settings](#)
- [HP Embedded Web Server](#)
- [HP Utility \(Mac OS X\)](#)
- [Use HP Web Jetadmin software](#)
- [Economy settings](#)
- [Product security features](#)
- [Upgrade the product firmware](#)

# Configure IP network settings

## Printer sharing disclaimer

HP does not support peer-to-peer networking, as the feature is a function of Microsoft operating systems and not of the HP print drivers. Go to Microsoft at [www.microsoft.com](http://www.microsoft.com).

## View or change network settings

Use the HP Embedded Web Server to view or change IP configuration settings.

1. Print a configuration page, and locate the IP address.
  - If you are using IPv4, the IP address contains only digits. It has this format:  
`xxx . xxx . xxx . xxx`
  - If you are using IPv6, the IP address is a hexadecimal combination of characters and digits. It has a format similar to this:  
`xxxx : : xxxx : xxxx : xxxx : xxxx`
2. To open the HP Embedded Web Server, type the IP address into the address line of a Web browser.
3. Click the **Networking** tab to obtain network information. You can change settings as needed.

## Manually configure IPv4 TCP/IP parameters from the control panel

Use the control-panel [Administration](#) menus to manually set an IPv4 address, subnet mask, and default gateway.

1. From the Home screen on the product control panel, scroll to and touch the [Administration](#) button.
2. Open the following menus:
  - [Network Settings](#)
  - [Jetdirect Menu](#)
  - [TCP/IP](#)
  - [IPV4 Settings](#)
  - [Config Method](#)
3. Select the [Manual](#) option, and then touch the [Save](#) button.
4. Open the [Manual Settings](#) menu.

5. Touch the [IP Address](#), [Subnet Mask](#), or [Default Gateway](#) option.
6. Touch the first field to open a keypad. Enter the correct digits for the field, and then touch the [OK](#) button.

Repeat the process for each field, and then touch the [Save](#) button.

## Manually configure IPv6 TCP/IP parameters from the control panel

Use the control-panel [Administration](#) menus to manually set an IPv6 address.

1. From the Home screen on the product control panel, scroll to and touch the [Administration](#) button.
2. To enable manual configuration, open the following menus:
  - [Network Settings](#)
  - [Jetdirect Menu](#)
  - [TCP/IP](#)
  - [IPv6 Settings](#)
  - [Address](#)
  - [Manual Settings](#)
  - [Enable](#)

Select the [On](#) option, and then touch the [Save](#) button.

3. To configure the address, touch the [Address](#) button and then touch the field to open a keypad.
4. Use the keypad to enter the address, and then touch the [OK](#) button.
5. Touch the [Save](#) button.

# HP Embedded Web Server

Use the HP Embedded Web Server to view product status, configure product network settings, and to manage printing functions from your computer instead of from the product control panel. The following are examples of what you can do using the HP Embedded Web Server:

- View product status information
- Determine the remaining life for all supplies and order new ones
- View and change tray configurations
- View and change the product control-panel menu configuration
- View and print internal pages
- Receive notification of product and supplies events
- View and change network configuration

To use the HP Embedded Web Server, your browser must meet the following requirements:

- Windows: Microsoft Internet Explorer 5.01 or later or Netscape 6.2 or later
- Mac OS X: Safari or Firefox using Bonjour or an IP address
- Linux: Netscape Navigator only
- HP-UX 10 and HP-UX 11: Netscape Navigator 4.7

The HP Embedded Web Server works when the product is connected to an IP-based network. The HP Embedded Web Server does not support IPX-based product connections. You do not have to have Internet access to open and use the HP Embedded Web Server.

When the product is connected to the network, the HP Embedded Web Server is automatically available.

## Open the HP Embedded Web Server

1. Identify the product IP address or host name. If the Network  button is visible on the Home screen on the product control panel, touch that button to display the address. Otherwise, follow these steps to print or view the product configuration page:
  - a. From the Home screen on the product control panel, scroll to and touch the [Administration](#) button.
  - b. Open the following menus:
    - [Reports](#)
    - [Configuration/Status Pages](#)
    - [Configuration Page](#)

- c. Touch the [Print](#) or [View](#) button.
  - d. Find the IP address or host name on the Jetdirect page.
2. In a supported Web browser on your computer, enter the product IP address or host name in the address/URL field.

## HP Embedded Web Server features

### Information tab

**Table 9-1 HP Embedded Web Server Information tab**

Menu	Description
<b>Device Status</b>	Shows the product status and shows the estimated life remaining of HP supplies. The page also shows the type and size of paper set for each tray. To change the default settings, click the <b>Change Settings</b> link.
<b>Job Log</b>	Shows a summary of all jobs the product has processed.
<b>Configuration Page</b>	Shows the information found on the configuration page.
<b>Supplies Status Page</b>	Shows the status of the supplies for the product.
<b>Event Log Page</b>	Shows a list of all product events and errors. Use the <b>HP Instant Support</b> link (in the <b>Other Links</b> area on all HP Embedded Web Server pages) to connect to a set of dynamic Web pages that help you solve problems. These pages also show additional services available for the product.
<b>Usage Page</b>	Shows a summary of the number of pages the product has printed, grouped by size, type, and paper print path.
<b>Device Information</b>	Shows the product network name, address, and model information. To customize these entries, click the <b>Device Information</b> menu on the <b>General</b> tab.
<b>Control Panel Snapshot</b>	Shows an image of the current screen on the control-panel display.
<b>Print</b>	Upload a print-ready file from your computer to print. The product uses the default print settings to print the file.
<b>Printable Reports and Pages</b>	Lists the internal reports and pages for the product. Select one or more items to print.

### General tab

**Table 9-2 HP Embedded Web Server General tab**

Menu	Description
<b>Control Panel Customization</b>	Reorder, show, or hide features on the control-panel display, and change the default display language.
<b>Quick Sets Setup</b>	Configure jobs that are available in the <a href="#">Quick Sets</a> area of the Home screen on the product control panel.
<b>Alerts</b>	Set up email alerts for various product and supplies events.

**Table 9-2 HP Embedded Web Server General tab (continued)**

Menu	Description
<b>Control Panel Administration Menu</b>	Shows the menu structure of the <a href="#">Administration</a> menu on the control panel.  <b>NOTE:</b> You can configure settings on this screen, but the HP Embedded Web Server provides more advanced configuration options than are available through the <a href="#">Administration</a> menu.
<b>AutoSend</b>	Configure the product to send automated emails regarding product configuration and supplies to specific email addresses.
<b>Edit Other Links</b>	Add or customize a link to another Web site. This link displays in the <b>Other Links</b> area on all HP Embedded Web Server pages.
<b>Ordering Information</b>	Enter information about ordering replacement toner cartridges. This information displays on the supplies status page.
<b>Device Information</b>	Name the product and assign an asset number to it. Enter the name of the primary contact who will receive information about the product.
<b>Language</b>	Set the language in which to display the HP Embedded Web Server information.
<b>Date and Time</b>	Set the date and time or synchronize with a network time server.
<b>Energy Settings</b>	Set or edit a wake time, sleep time, and sleep delay for the product. You can set a different schedule for each day of the week and for holidays. You can also set which interactions with the product cause it to wake from sleep mode.
<b>Backup and Restore</b>	Create a backup file that contains product and user data. If necessary, you can use this file to restore data to the product.
<b>Restore Factory Settings</b>	Restore product settings to the factory defaults.
<b>Solution Installer</b>	Install third-party software programs that can enhance the product functionality.
<b>Firmware Upgrade</b>	Download and install product firmware upgrade files.
<b>Quota and Statistics Services</b>	Provides connection information about third-party job-statistics services.

## Copy/Print tab

**Table 9-3 HP Embedded Web Server Copy/Print tab**

Menu	Description
<b>Retrieve from USB Setup</b>	Enable or disable the <a href="#">Retrieve from USB</a> menu on the control panel.
<b>Manage Stored Jobs</b>	Enable or disable the ability to store jobs in the product memory, and configure job-storage options.
<b>Adjust Paper Types</b>	If print quality problems occur when using a specific paper type, you can override factory-default mode settings.
<b>General Print Settings</b>	Configure settings for all print jobs, including copy jobs or received faxes.
<b>Copy Settings</b>	Configure the default options for copy jobs.
<b>Manage Trays</b>	Configure settings for paper trays.



## Scan/Digital Send tab

**Table 9-4 HP Embedded Web Server Scan/Digital Send tab**

Menu	Description
<b>Address Book</b>	Add email addresses into the product one at a time, and edit email addresses that have already been saved in the product. You can also use the <b>Import/Export</b> tab to transfer a large list of frequently-used email addresses to the product all at once, rather than adding them one at a time.
<b>E-mail and Save to Network Folder Quick Setup Wizards</b>	Configure the product to send scanned images as email attachments.  Configure the product to save scanned images to network-folder Quick Sets. Quick Sets provide easy access to files saved on the network.
<b>E-mail Setup</b>	Configure the default email settings for digital sending, including the following: <ul style="list-style-type: none"><li>• Settings for the outgoing mail (SMTP) server</li><li>• Default settings for E-mail Quick Sets jobs</li><li>• Default message settings, such as the "From" address and the subject line</li><li>• Settings for digital signatures and encryption</li><li>• Settings for email notifications</li><li>• Default scan settings for email jobs</li><li>• Default file settings for email jobs</li></ul>
<b>Save to Network Folder Setup</b>	Configure the network folder settings for digital sending, including the following: <ul style="list-style-type: none"><li>• Default settings for Quick Sets jobs saved in a network folder</li><li>• Settings for notifications</li><li>• Default scan settings for jobs saved in a network folder</li><li>• Default file settings for for jobs saved in a network folder</li></ul>
<b>Save to USB Setup</b>	Configure the USB settings for digital sending, including the following: <ul style="list-style-type: none"><li>• Default settings for Quick Sets jobs saved on a USB flash drive</li><li>• Settings for notifications</li><li>• Default scan settings for jobs saved on a USB flash drive</li><li>• Default file settings for for jobs saved on a USB flash drive</li></ul>
<b>OXPd: Workflow</b>	Use third-party workflow tools.
<b>Digital Sending Software Setup</b>	Configure settings related to using optional Digital Sending software.

## Fax tab (Fax models only)

**Table 9-5 HP Embedded Web Server Fax tab**

Menu	Description
<b>Fax Send Setup</b>	Configure settings for sending faxes, including the following: <ul style="list-style-type: none"><li>• Default common job settings for outgoing faxes</li><li>• Default setting for sending faxes using the internal fax modem</li><li>• Settings for using a LAN fax service</li><li>• Settings for using an Internet fax service</li></ul>
<b>Speed Dials</b>	Manage fax speed dial numbers. You can also import .CSV files containing email addresses, fax numbers, or user records, so that they can be accessed on this product. You can also export email, fax, or user records from the product into a file on your computer. You can then use this file as a data backup, or you can use it to import the records onto another HP product.
<b>Fax Receive Setup</b>	Configure default print options for incoming faxes, and set up a fax printing schedule.
<b>Fax Archive and Forwarding</b>	Enable or disable fax archiving and fax forwarding, and configure basic settings for each. <ul style="list-style-type: none"><li>• Fax archiving is a method to send a copy of all incoming and outgoing faxes to an email address.</li><li>• Fax forwarding is a method to forward incoming faxes to a different fax device.</li></ul>
<b>Fax Activity Log</b>	Contains a list of the faxes that have been sent from or received by this product.

## Troubleshooting tab

**Table 9-6 HP Embedded Web Server Troubleshooting tab**

Menu	Description
<b>General Troubleshooting</b>	Select from a variety of reports and tests to help solve problems with the product.
<b>Retrieve Diagnostic Data</b>	Export product information to a file that can be useful for detailed problem analysis. <b>NOTE:</b> This item is available only if an administrator password is set from the <b>Security</b> tab.
<b>Firmware Upgrade</b>	Download and install product firmware upgrade files.
<b>Restore Factory Settings</b>	Restore product settings to factory defaults.

## Security tab

**Table 9-7 HP Embedded Web Server Security tab**

Menu	Description
<b>General Security</b>	<p>Configure an administrator password so you can restrict access to certain features on the product.</p> <p>Set PJI password for processing PJI commands.</p> <p>Set file system access and firmware upgrade security.</p> <p>Enable or disable the Host USB port on the control panel or the USB connectivity port on the formatter for printing directly from a computer.</p> <p>View the status of all security settings.</p>
<b>Access Control</b>	<p>Configure access to product functions for specific individuals or groups. Also set up user accounts and select the method by which individuals sign in to the product.</p>
<b>Protect Stored Data</b>	<p>Configure and manage the internal hard drive for the product. This product includes an encrypted hard drive for maximum security.</p> <p>Configure settings for jobs that are stored on the product hard drive.</p>
<b>Certificate Management</b>	<p>Install and manage security certificates for access to the product and the network.</p>
<b>Self Test</b>	<p>Verify that the security functions are running according to expected system parameters.</p>

## HP Web Services tab

Use the **HP Web Services** tab to configure and enable HP Web Services for this product. You must enable HP Web Services to use the HP ePrint feature.

## Networking tab

Use the **Networking** tab to configure and secure network settings for the product when it is connected to an IP-based network. This tab does not display if the product is connected to other types of networks.

## Other Links list



**NOTE:** You can configure which links display in the **Other Links** list by using the **Edit Other Links** menu on the **General** tab. The following are the default links.

**Table 9-8 HP Embedded Web Server Other Links list**

Menu	Description
<b>HP Instant Support</b>	<p>Connects you to the HP Web site to help you find solutions to product problems.</p>

**Table 9-8 HP Embedded Web Server Other Links list (continued)**

<b>Menu</b>	<b>Description</b>
<b>Shop for Supplies</b>	Connects to the HP SureSupply Web site, where you can receive information on options for purchasing original HP supplies, such as toner cartridges and paper.
<b>Product Support</b>	Connects to the support site for the product, from which you can search for help regarding various topics.

# HP Utility (Mac OS X)

HP Utility is a software program that provides access to the product in Mac OS X.

You can use HP Utility when the product uses a USB cable or is connected to a TCP/IP-based network.

## Open HP Utility

From the Finder, click **Applications**, click **Utilities**, and then click **HP Utility**.

If HP Utility is not included in the **Utilities** list, use the following procedure to open it:

1. At the computer, open the Apple  menu, click the **System Preferences** menu, and then click the **Print & Fax** icon (OS X v10.5 and 10.6) or the **Print & Scan** icon (OS X v10.7).
2. Select the product in the left side of the window.
3. Click the **Options & Supplies** button.
4. Click the **Utility** tab.
5. Click the **Open Printer Utility** button.

## HP Utility features

HP Utility consists of pages that you open by clicking in the **All Settings** list. At the top of any page, click the icons to access HP Web sites for the following information:

- **HP Support**
- **Supplies**
- **Registration**
- **Recycling**

The following table describes the tasks that you can perform with HP Utility.

Menu	Item	Description
<b>Information And Support</b>	<b>Supplies Status</b>	Shows the product supplies status and provides links for ordering supplies online.
	<b>Device Information</b>	Shows information about the currently selected product.
	<b>File Upload</b>	Transfers files from the computer to the product.
	<b>Upload Fonts</b>	Transfers font files from the computer to the product.
	<b>HP ePrintCenter</b>	Accesses the HP ePrintCenter.
	<b>Update Firmware</b>	Transfers a firmware update file to the product.

**NOTE:** This option is available only after you open the **View** menu and select the **Show Advanced Options** item.

Menu	Item	Description
	<b>Commands</b>	Sends special characters or print commands to the product after the print job.  <b>NOTE:</b> This option is available only after you open the <b>View</b> menu and select the <b>Show Advanced Options</b> item.
<b>Printer Settings</b>	<b>Supplies Management</b>	Configures how the product should behave when supplies are nearing the end of their estimated life.
	<b>Trays Configuration</b>	Changes the default tray settings.
	<b>Output Devices</b>	Manages settings for optional output accessories.
	<b>Duplex Mode</b>	Turns on the automatic two-sided printing mode.
	<b>Protect Direct Ports</b>	Disables printing over USB or parallel ports.
	<b>Stored Jobs</b>	Manages print jobs that are stored on the product hard disk.
	<b>Network Settings</b>	Configures the network settings, such as the IPv4 and IPv6 settings.
	<b>Additional Settings</b>	Provides access to the HP Embedded Web Server.
<b>Scan Settings</b>	<b>Scan to E-mail</b>	Opens the HP Embedded Web Server page for configuring settings for scanning to email.  <b>NOTE:</b> USB connections are not supported.
	<b>Scan to Network Folder</b>	Opens the HP Embedded Web Server page for configuring settings for scanning to a network folder.  <b>NOTE:</b> USB connections are not supported.

## Use HP Web Jetadmin software

HP Web Jetadmin is an award-winning, industry-leading tool for efficiently managing a wide variety of networked HP products, including printers, multifunction products, and digital senders. This single solution allows you to remotely install, monitor, maintain, troubleshoot, and secure your printing and imaging environment — ultimately increasing business productivity by helping you save time, control costs, and protect your investment.

HP Web Jetadmin upgrades are periodically made available to provide support for specific product features. Go to [www.hp.com/go/webjetadmin](http://www.hp.com/go/webjetadmin) and click the **Self Help and Documentation** link to learn more about upgrades.

# Economy settings

## Print with EconoMode

This product has an EconoMode option for printing drafts of documents. Using EconoMode can use less toner and decrease the cost per page. However, using EconoMode can also reduce print quality.

HP does not recommend the full-time use of EconoMode. If EconoMode is used full-time, the toner supply might outlast the mechanical parts in the toner cartridge. If print quality begins to degrade and is no longer acceptable, consider replacing the toner cartridge.

 **NOTE:** This feature is available with the PCL 6 print driver for Windows. If you are not using that driver, you can enable the feature by using the HP Embedded Web Server.

1. From the software program, select the **Print** option.
2. Select the product, and then click the **Properties** or **Preferences** button.
3. Click the **Paper/Quality** tab.
4. Click the **EconoMode** check box.
5. Click the **OK** button to close the **Document Properties** dialog box. In the **Print** dialog, click the **OK** button to print the job.

## Optimize speed or energy use

By default the product stays warm between jobs to optimize speed and print the first page of jobs faster. You can set the product to cool between jobs, which conserves energy.

1. From the Home screen on the product control panel, scroll to and touch the [Administration](#) button.
2. Open the following menus:
  - [General Settings](#)
  - [Energy Settings](#)
  - [Optimum Speed/Energy Usage](#)
3. Select the option that you want to use, and then touch the [Save](#) button.



## Set sleep mode

1. From the Home screen on the product control panel, scroll to and touch the [Administration](#) button.
2. Open each of the following menus:
  - a. [General Settings](#)
  - b. [Sleep Timer Settings](#)
  - c. [Sleep Mode/Auto off After](#)
3. Select the appropriate time period, and then touch the [Save](#) button.

---

 **NOTE:** The sleep-mode default time is 45 minutes.

---

## Set the sleep schedule

---

 **NOTE:** You must configure the date and time settings before you can use the [Sleep Schedule](#) feature.

---

1. From the Home screen on the product control panel, scroll to and touch the [Administration](#) button.
2. Open the following menus:
  - [General Settings](#)
  - [Date/Time Settings](#)
3. Open the [Date/Time Format](#) menu and configure the following settings:
  - [Date Format](#)
  - [Time Format](#)
4. Touch the [Save](#) button.
5. Open the [Date/Time](#) menu and configure the following settings:
  - [Date](#)
  - [Time](#)
  - [Time Zone](#)

If you are in an area that uses daylight savings time, select the [Adjust for Daylight Savings](#) box.
6. Touch the [Save](#) button.
7. Touch the back-arrow button to return to the [Administration](#) screen.
8. Open the following menus:
  - [General Settings](#)
  - [Energy Settings](#)
  - [Sleep Schedule](#)

9. Touch the Add  button, and then select the type of event to schedule: [Wake](#) or [Sleep](#).
10. Configure the following settings:
  - [Time](#)
  - [Event Days](#)
11. Touch the [OK](#) button, and then touch the [Save](#) button.

# Product security features

## Security statements

The product supports security standards and recommended protocols that help you keep the product secure, protect critical information on your network, and simplify the way you monitor and maintain the product.

For in-depth information about HP's secure imaging and printing solutions, visit [www.hp.com/go/secureprinting](http://www.hp.com/go/secureprinting). The site provides links to white papers and FAQ documents about security features.

## IP Security

IP Security (IPsec) is a set of protocols that control IP-based network traffic to and from the product. IPsec provides host-to-host authentication, data integrity, and encryption of network communications.

For products that are connected to the network and have an HP Jetdirect print server, you can configure IPsec by using the **Networking** tab in the HP Embedded Web Server.

## Sign in to the product

Some features on the product control panel can be secured so that unauthorized people cannot use them. When a feature is secured, the product prompts you to sign in before you can use it. You can also sign in without waiting for a prompt by touching the **Sign In** button on the Home screen.

Typically, you use the same user name and password that you use to sign in to your computer on the network. Consult the network administrator for this product if you have questions about which credentials to use.

After you have signed in to the product, a **Sign Out** button displays on the control panel. To maintain security for the product, touch the **Sign Out** button when you have finished using the product.

## Assign a system password

Assign an administrator password for access to the product and the HP Embedded Web Server so that unauthorized users cannot change the product settings.

1. Open the HP Embedded Web Server by entering the product IP address into the address line of a Web browser.
2. Click the **Security** tab.
3. Open the **General Security** menu.
4. In the **Username** field, enter the name to associate with the password.

5. Enter the password in the **New Password** field, and then enter it again in the **Verify password** field.

 **NOTE:** If you are changing an existing password, you must first enter the existing password in the **Old Password** field.

6. Click the **Apply** button. Make note of the password and store it in a safe place.

## Encryption support: HP High-Performance Secure Hard Disks

The hard disk provides hardware-based encryption so you can securely store sensitive data without impacting product performance. This hard disk uses the latest Advanced Encryption Standard (AES) and has versatile time-saving features and robust functionality.

Use the **Security** menu in the HP Embedded Web Server to configure the disk.

For more information about the encrypted hard disk, see the *HP High-Performance Secure Hard Disk Setup Guide*.

1. Go to [www.hp.com/support](http://www.hp.com/support).
2. Enter **Secure Hard Disk** into the search field and press **Enter**.
3. Click the **HP High-Performance Secure Hard Disk Drive** link.
4. Click the **Manuals** link.

## Lock the formatter cage

The formatter cage, on the back of the product, has a slot that you can use to attach a security cable. Locking the formatter cage prevents someone from removing valuable components from the formatter.

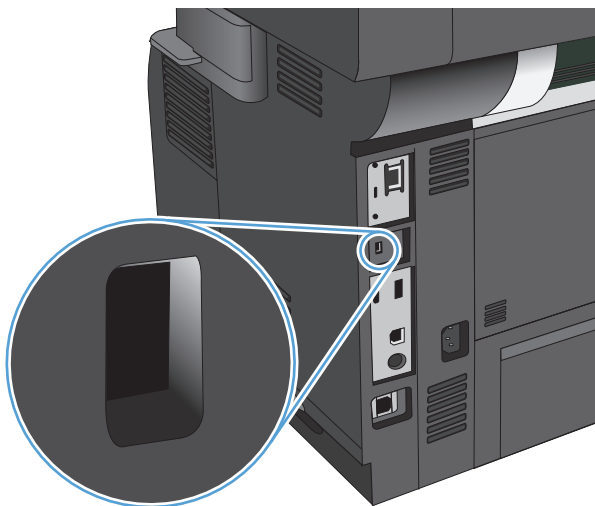

## Upgrade the product firmware

Software and firmware upgrades and installation instructions for this product are available at [www.hp.com/support/lj500MFPM525](http://www.hp.com/support/lj500MFPM525). Click **Support & Drivers**, click the operating system, and then select the download for the product.



---

# 10 Solve problems

- [Solve problems checklist](#)
- [Factors that affect product performance](#)
- [Restore factory-set defaults](#)
- [Control-panel help](#)
- [Paper feeds incorrectly or becomes jammed](#)
- [Clear jams](#)
- [Change jam recovery](#)
- [Improve print quality](#)
- [Improve copy quality](#)
- [Improve scan quality](#)
- [Improve fax quality](#)
- [The product does not print or it prints slowly](#)
- [Solve easy-access USB printing problems](#)
- [Solve USB connection problems](#)
- [Solve wired network problems](#)
- [Solve fax problems](#)
- [Solve product software problems \(Windows\)](#)
- [Solve product software problems \(Mac OS X\)](#)
- [Remove software \(Windows\)](#)
- [Remove the print driver \(Mac OS X\)](#)

# Solve problems checklist

Follow these steps when trying to solve a problem with the product.

1. If the control panel is blank or black, complete these steps:
  - a. Check the power cable.
  - b. Check that the power is turned on.
  - c. Make sure that the line voltage is correct for the product power configuration. (See the label that is on the back of the product for voltage requirements.) If you are using a power strip and its voltage is not within specifications, connect the product directly into the electrical outlet. If it is already connected into the outlet, try a different outlet.
  - d. If none of these measures restores power, contact HP Customer Care.
2. The control panel should indicate a **Ready** status. If an error message displays, resolve the error.
3. Check the cabling.
  - a. Check the cable connection between the product and the computer or network port. Make sure that the connection is secure.
  - b. Make sure that the cable itself is not faulty by using a different cable, if possible.
  - c. Check the network connection.
4. Ensure that the selected paper size and type meet specifications. Also open the **Trays** menu on the product control panel and verify that the tray is configured correctly for the paper type and size.
5. Print a configuration page. If the product is connected to a network, an HP Jetdirect page also prints.
  - a. From the Home screen on the product control panel, scroll to and touch the **Administration** button.
  - b. Open the following menus:
    - **Reports**
    - **Configuration/Status Pages**
    - **Configuration Page**
  - c. Touch the **Print** button to print the page.

If the pages do not print, check that at least one tray contains paper.

If the page jams in the product, follow the instructions on the control panel to clear the jam.

If the page does not print correctly, the problem is with the product hardware. Contact HP Customer Care.

If the page prints correctly, then the product hardware is working. The problem is with the computer you are using, with the print driver, or with the program.



- 6.** Verify that you have installed the print driver for this product. Check the program to make sure that you are using the print driver for this product. The print driver is on the CD that came with the product. You can also download the print driver from this Web site: [www.hp.com/go/lj500MFP525\\_software](http://www.hp.com/go/lj500MFP525_software).
- 7.** Print a short document from a different program that has worked in the past. If this solution works, then the problem is with the program. If this solution does not work (the document does not print), complete these steps:
  - a.** Try printing the job from another computer that has the product software installed.
  - b.** If you connected the product to the network, connect the product directly to a computer with a USB cable. Redirect the product to the correct port, or reinstall the software, selecting the new connection type that you are using.

# Factors that affect product performance

Several factors affect the time it takes to print a job:

- Maximum product speed, measured in pages per minute (ppm)
- The use of special paper (such as transparencies, heavy paper, and custom-size paper)
- Product processing and download time
- The complexity and size of graphics
- The speed of the computer you are using
- The USB connection
- The product I/O configuration
- The network operating system and configuration (if applicable)
- The print driver that you are using

## Restore factory-set defaults



1. From the Home screen on the product control panel, scroll to and touch the [Administration](#) button.
2. Open the following menus:
  - [General Settings](#)
  - [Restore Factory Settings](#)
3. Select one or more categories of settings from the list, and then touch the [Reset](#) button.

## Control-panel help

The product has a built-in Help system that explains how to use each screen. To open the Help system, touch the Help  button in the upper-right corner of the screen.

For some screens, the Help opens to a global menu where you can search for specific topics. You can browse through the menu structure by touching the buttons in the menu.

For screens that contain settings for individual jobs, the Help opens to a topic that explains the options for that screen.

If the product alerts you of an error or warning, touch the Error  button or the Warning  button to open a message that describes the problem. The message also contains instructions to help solve the problem.

You can print a report of the complete [Administration](#) menu so you can more easily navigate to the individual settings you need.

1. From the Home screen on the product control panel, scroll to and touch the [Administration](#) button.
2. Open the following menus:
  - [Reports](#)
  - [Configuration/Status Pages](#)
3. Select the [Administration Menu Map](#) option.
4. Touch the [Print](#) button to print the report.

# Paper feeds incorrectly or becomes jammed

- [The product does not pick up paper](#)
- [The product picks up multiple sheets of paper](#)
- [The document feeder jams, skews, or picks up multiple sheets of paper](#)
- [Prevent paper jams](#)

## The product does not pick up paper

If the product does not pick up paper from the tray, try these solutions.

1. Open the product and remove any jammed sheets of paper.
2. Load the tray with the correct size of paper for your job.
3. Make sure the paper size and type are set correctly on the product control panel.
4. Make sure the paper guides in the tray are adjusted correctly for the size of paper. Adjust the guides to the appropriate indentation in the tray.
5. Check the product control panel to see if the product is waiting for you to acknowledge a prompt to feed the paper manually. Load paper, and continue.
6. The rollers above the tray might be contaminated. Clean the rollers with a lint-free cloth dampened with warm water.

## The product picks up multiple sheets of paper

If the product picks up multiple sheets of paper from the tray, try these solutions.

1. Remove the stack of paper from the tray and flex it, rotate it 180 degrees, and flip it over. *Do not fan the paper.* Return the stack of paper to the tray.
2. Use only paper that meets HP specifications for this product.
3. Use paper that is not wrinkled, folded, or damaged. If necessary, use paper from a different package.
4. Make sure the tray is not overfilled. If it is, remove the entire stack of paper from the tray, straighten the stack, and then return some of the paper to the tray.
5. Make sure the paper guides in the tray are adjusted correctly for the size of paper. Adjust the guides to the appropriate indentation in the tray.
6. Make sure the printing environment is within recommended specifications.

## The document feeder jams, skews, or picks up multiple sheets of paper

- The original might have something on it, such as staples or self-adhesive notes, that must be removed.
- Check that all rollers are in place and that the roller-access cover inside the document feeder is closed.
- Make sure that the top document-feeder cover is closed.
- The pages might not be placed correctly. Straighten the pages and adjust the paper guides to center the stack.
- The paper guides must be touching the sides of the paper stack to work correctly. Make sure that the paper stack is straight and the guides are against the paper stack.
- The document feeder input tray or output bin might contain more than the maximum number of pages. Make sure the paper stack fits below the guides in the input tray, and remove pages from the output bin.
- Verify that there are no pieces of paper, staples, paper clips, or other debris in the paper path.
- Clean the document-feeder rollers and the separation pad. Use compressed air or a clean, lint-free cloth moistened with warm water. If misfeeds still occur, replace the rollers.
- From the Home screen on the product control panel, scroll to and touch the [Supplies](#) button. Check the status of the document-feeder kit, and replace it if necessary.

## Prevent paper jams

To reduce the number of paper jams, try these solutions.

1. Use only paper that meets HP specifications for this product.
2. Use paper that is not wrinkled, folded, or damaged. If necessary, use paper from a different package.
3. Use paper that has not previously been printed or copied on.
4. Make sure the tray is not overfilled. If it is, remove the entire stack of paper from the tray, straighten the stack, and then return some of the paper to the tray.
5. Make sure the paper guides in the tray are adjusted correctly for the size of paper. Adjust the guides so they are touching the paper stack without bending it.
6. Make sure that the tray is fully inserted in the product.
7. If you are printing on heavy, embossed, or perforated paper, use the manual feed feature and feed sheets one at a time.
8. From the Home screen on the product control panel, scroll to and touch the [Trays](#) button. Verify that the tray is configured correctly for the paper type and size.
9. Make sure the printing environment is within recommended specifications.

# Clear jams

## Auto-navigation for clearing jams

The auto-navigation feature assists you in clearing jams by providing step-by-step instructions on the product control panel. When you complete a step, the product displays instructions for the next step until you have completed all steps in the procedure.

## Jam locations

Use this illustration to identify locations of jams. In addition, instructions display on the control panel to direct you to the location of jammed paper and how to clear it.

 **NOTE:** Internal areas of the product that might need to be opened to clear jams have green handles or green labels.

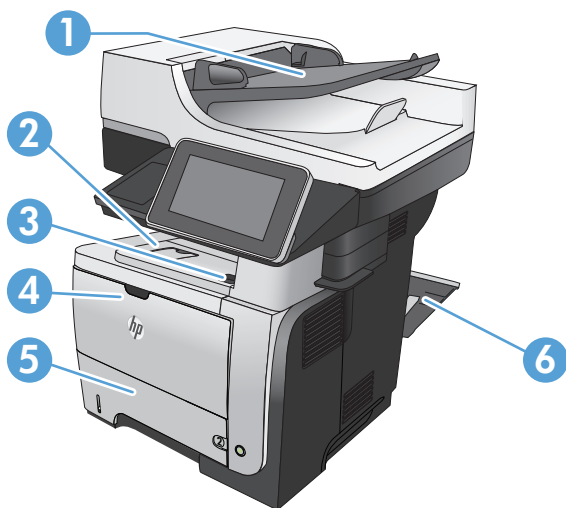

1	Document-feeder area
2	Output-bin area
3	Top-cover and toner-cartridge area
4	Tray 1 area
5	Tray 2 pickup area Duplexing area (remove Tray 2 for access)
6	Rear door area

## Clear jams in the document feeder

1. Lift the latch to release the document-feeder cover.

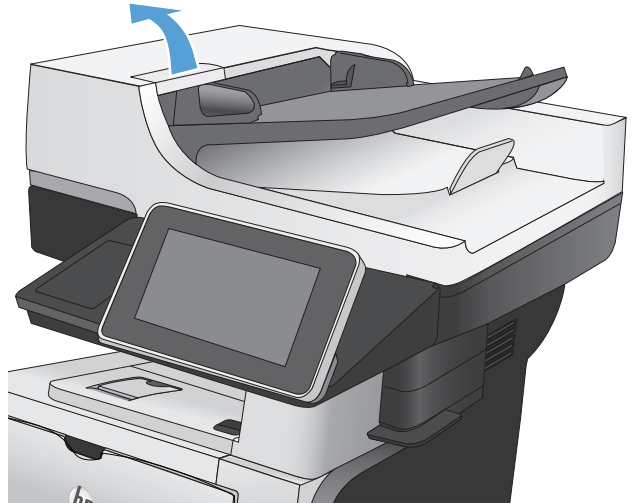

2. Open the document-feeder cover.

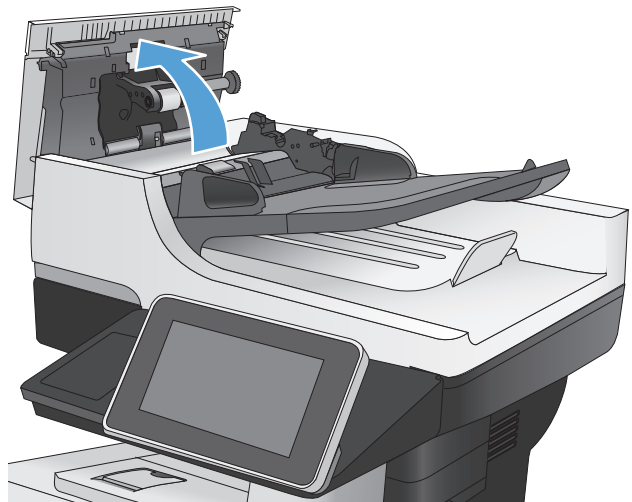



3. Lift the jam-access door, and remove any jammed paper.

If necessary, rotate the green wheel at the front of the document feeder to remove jammed paper.

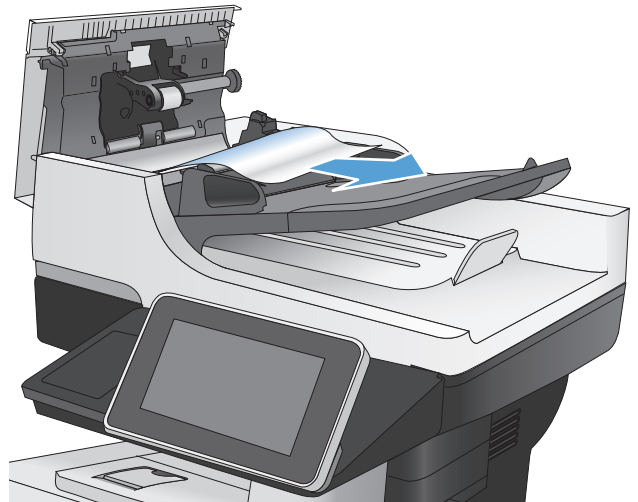

4. Close the document feeder.  
Close the document-feeder cover.

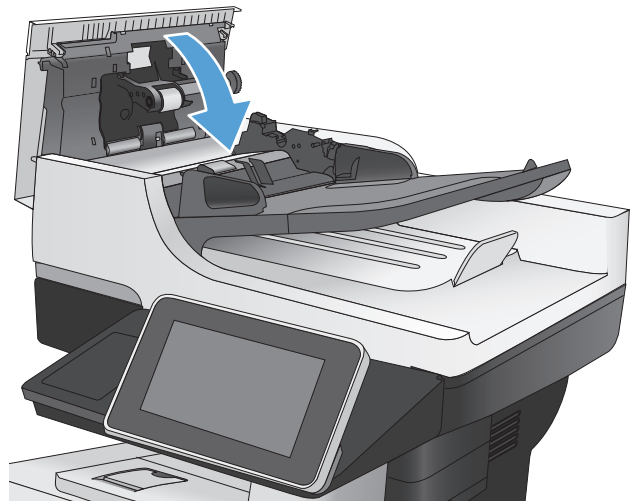

## Clear jams in the output-bin area

1. If paper is visible from the output bin, grasp the leading edge and remove it.



## Clear jams in Tray 1

1. If most of the sheet of paper is visible in the tray, slowly pull the jammed paper out of the product.

If most of the sheet of paper has been pulled inside the product, continue with the following steps.

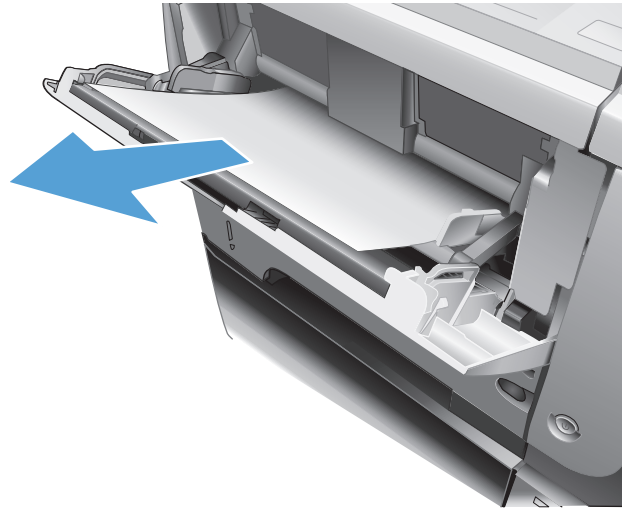

2. Press the front-door-release button.



3. Open the front door.



4. Remove the toner cartridge.

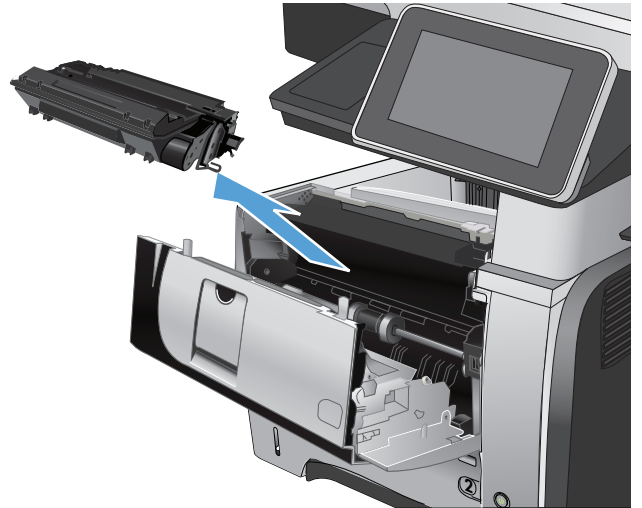

5. Lift the jam-access covers and remove any jammed paper.

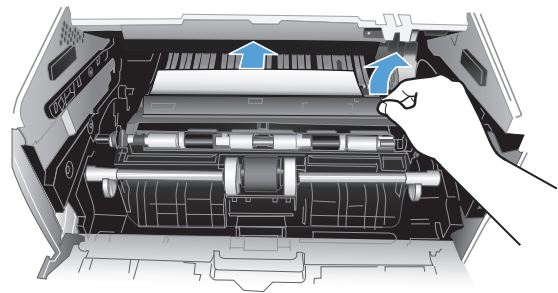

6. Reinsert the toner cartridge.



7. Close the front door.



## Clear jams in Tray 2 or an optional 500-sheet tray

1. Remove the tray from the product.

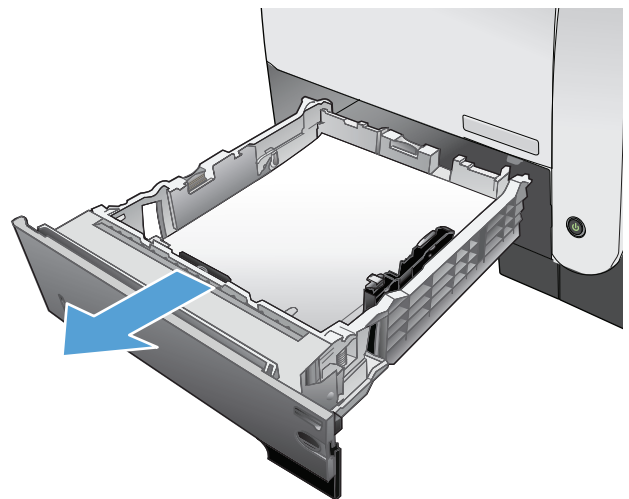

2. Remove the paper from the tray, and discard any damaged paper.

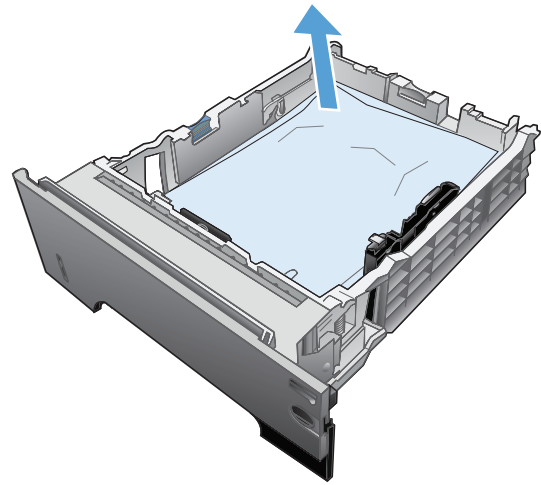

3. Verify that the rear paper guide is adjusted to the indentation for the correct paper size. If necessary, pinch the release and move the rear paper guide to the correct position. It should click into place.

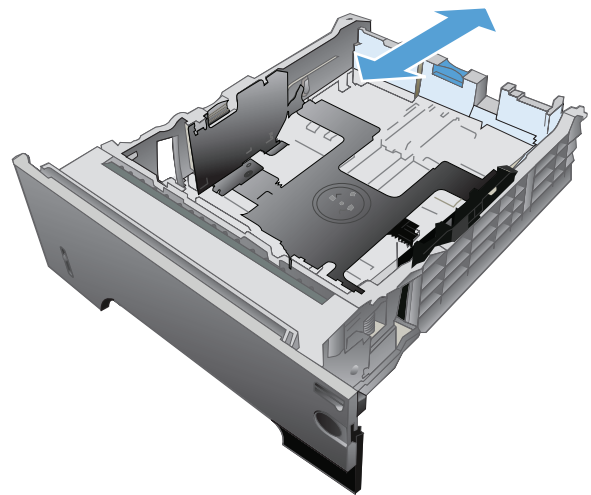

4. Load the paper into the tray. Make sure that the stack is flat at all four corners and that the top of the stack is below the maximum-height indicators.

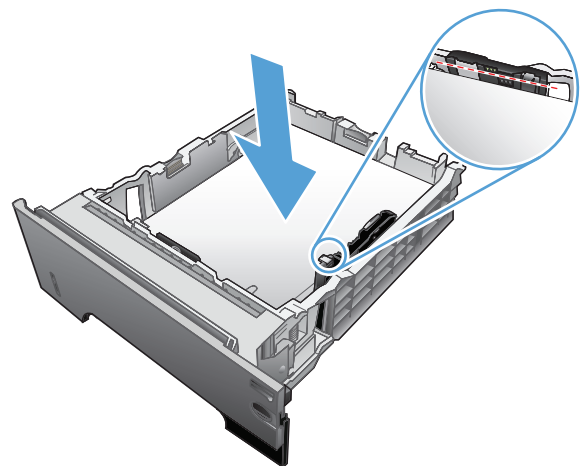

5. Reinsert and close Tray 2.

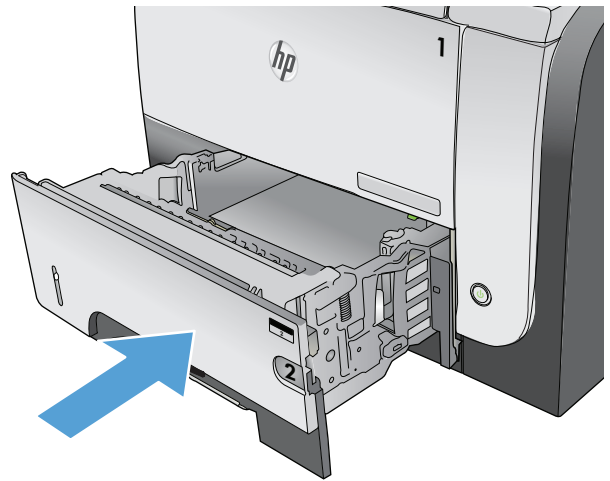

6. Press the front-door-release button.



7. Open the front door.

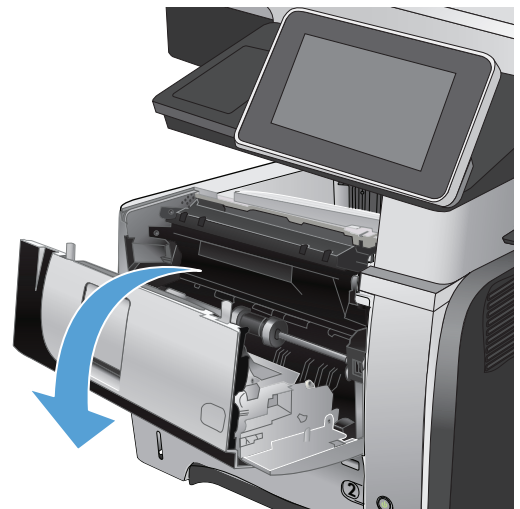

8. Remove the toner cartridge.

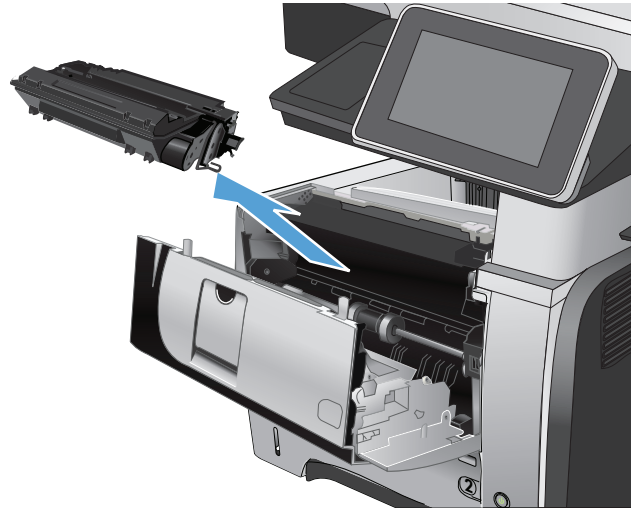

9. Lift the jam-access covers and remove any jammed paper.

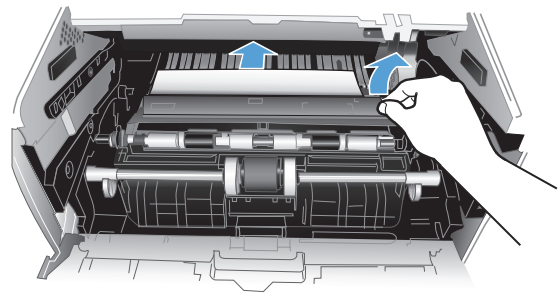

**10.** Reinsert the toner cartridge.



**11.** Close the front door.



## Clear jams in the toner-cartridge area

**1.** Press the front-door-release button.





2. Open the front door.



3. Remove the toner cartridge.



4. Lift the jam-access covers and remove any jammed paper.

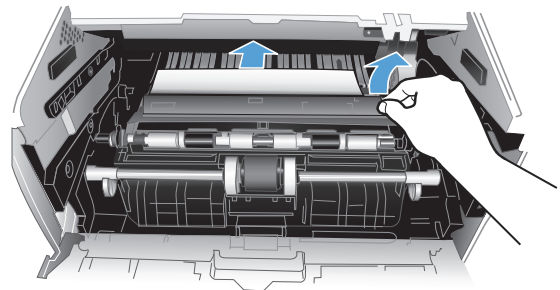

5. Reinsert the toner cartridge.



6. Close the front door.



## Clear jams in the rear-door and the fuser area

1. Open the rear door, and push down so it is fully opened to a 90° angle.

**CAUTION:** The fuser can be hot while the product is in use. Wait for the fuser to cool before clearing jams.

**NOTE:** The rear door has two positions. It opens to a 45° angle for the rear output bin and to a 90° angle for clearing jams.



2. Remove any jammed paper.



3. Press the front-door-release button.



4. Open the front door.



5. Remove the toner cartridge.

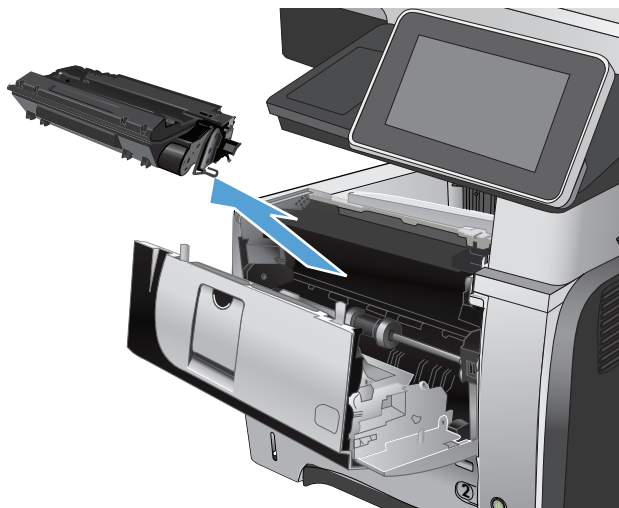

6. Lift the jam-access covers and remove any jammed paper.

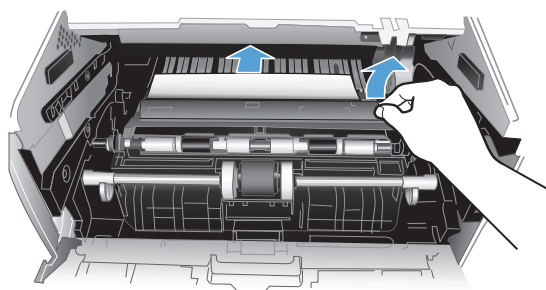

7. Reinsert the toner cartridge.

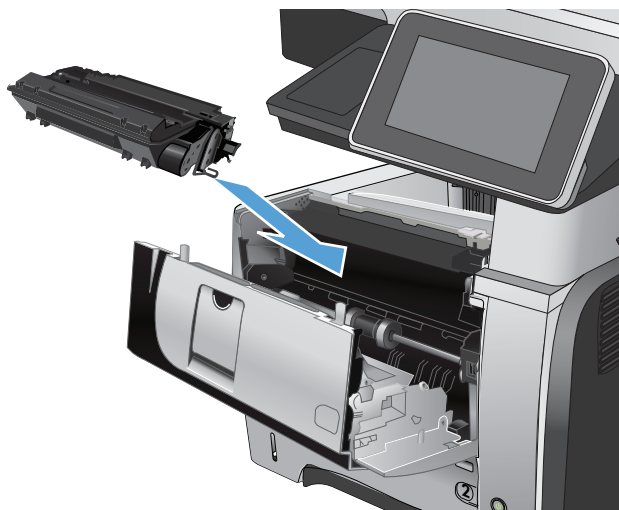

8. Close the front door.



9. Close the rear door.



## Clear jams in the duplexer

1. Completely remove Tray 2 from the product.

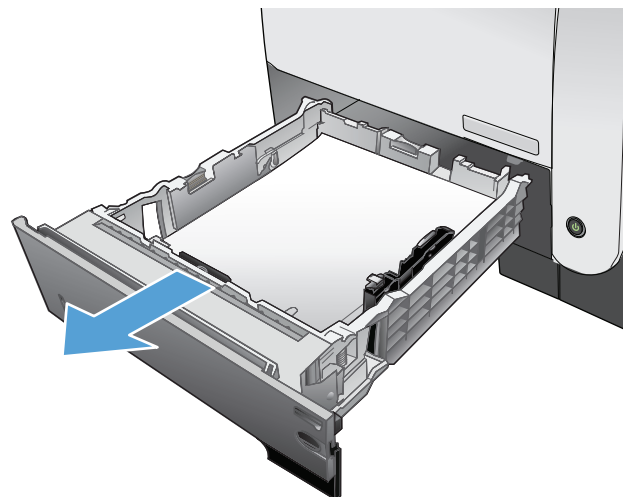

2. Push the green button to release the duplex pan.

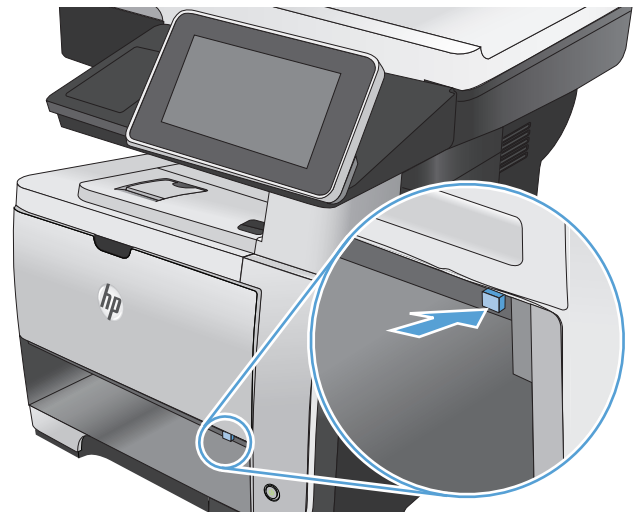

3. Remove any jammed paper.

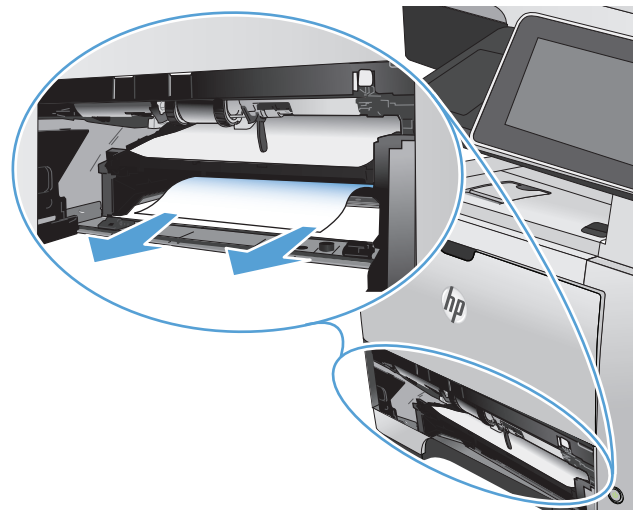

4. Close the duplex pan.

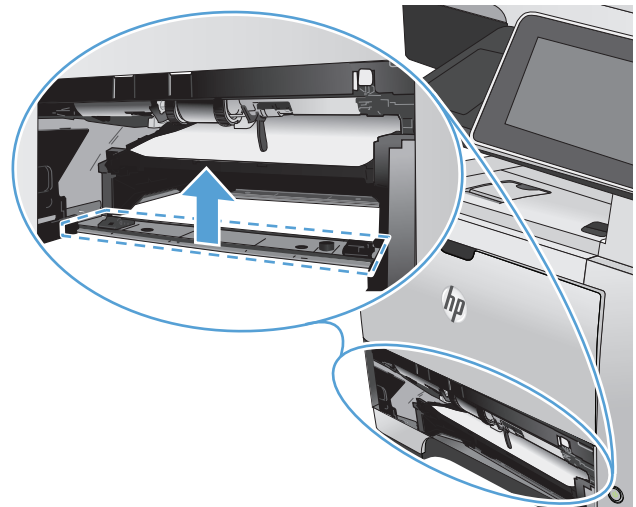

5. Reinsert Tray 2.

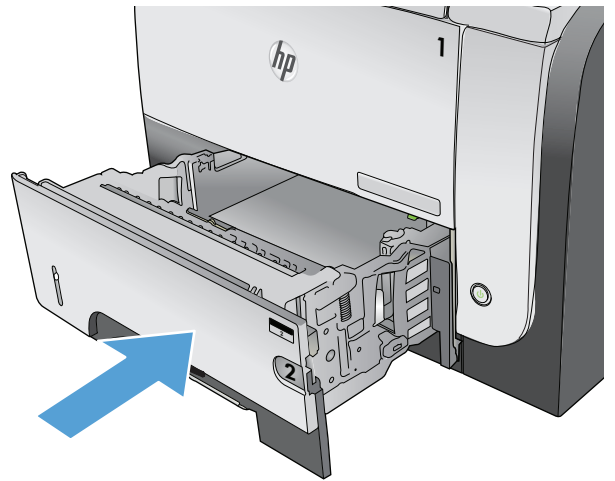

6. Open the rear door, and push down so it is fully opened to a 90° angle.

**NOTE:** The rear door has two positions. It opens to a 45° angle for the rear output bin and to a 90° angle for clearing jams.



7. Remove any jammed paper.



8. Press the front-door-release button.



9. Open the front door.

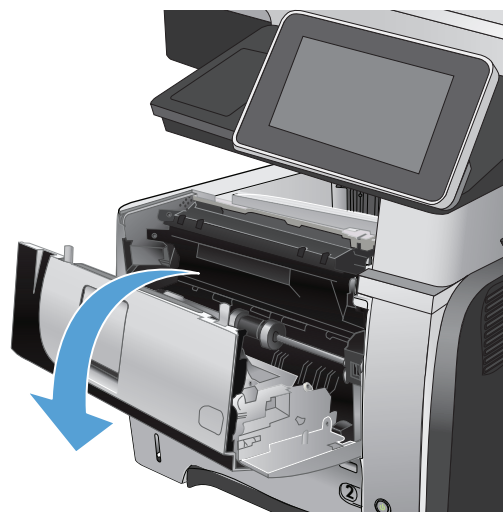

10. Remove the toner cartridge.

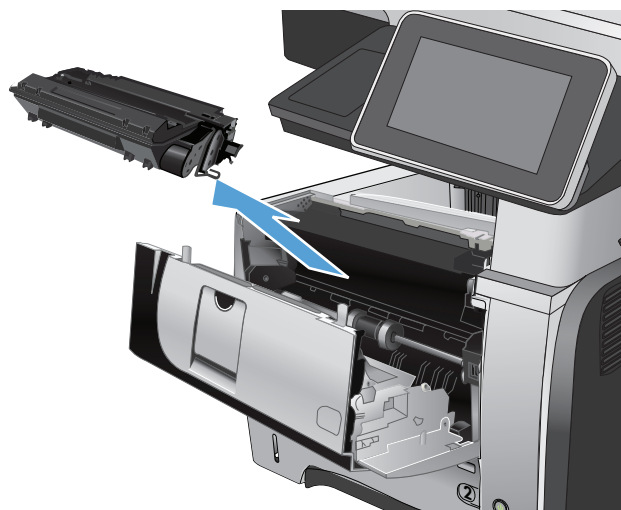



11. Lift the jam-access covers and remove any jammed paper.

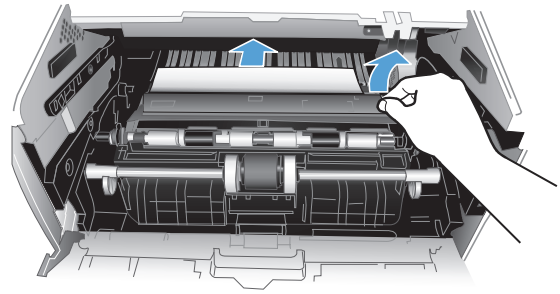

12. Reinsert the toner cartridge.



**13.** Close the front door.



**14.** Close the rear door.



# Change jam recovery

This product provides a jam recovery feature that reprints jammed pages.

1. From the Home screen on the product control panel, scroll to and touch the [Administration](#) button.
  2. Open the [General Settings](#) menu, and then open the [Jam Recovery](#) menu.
  3. Select one of the following options:
    - [Auto](#) — The product attempts to reprint jammed pages when sufficient memory is available. This is the default setting.
    - [Off](#) — The product does not attempt to reprint jammed pages. Because no memory is used to store the most recent pages, performance is optimal.
- 
-  **NOTE:** Some pages can be lost if the product runs out of paper while printing a duplex job with Jam Recovery set to [Off](#).
- 
- [On](#) — The product always reprints jammed pages. Additional memory is allocated to store the last few pages printed.

# Improve print quality

## Print from a different software program

Try printing from a different software program. If the page prints correctly, the problem is with the software program from which you were printing.

## Set the paper-type setting for the print job

Check the paper type setting If you are printing from a software program and the pages have any of these problems:

- smeared print
- fuzzy print
- dark print
- curled paper
- scattered dots of toner
- loose toner
- small areas of missing toner

## Check the paper type setting (Windows)

1. From the software program, select the **Print** option.
2. Select the product, and then click the **Properties** or **Preferences** button.
3. Click the **Paper/Quality** tab.
4. From the **Paper type** drop-down list, click the **More...** option.
5. Expand the list of **Type is:** options.
6. Expand the category of paper types that best describes your paper.
7. Select the option for the type of paper you are using, and click the **OK** button.
8. Click the **OK** button to close the **Document Properties** dialog box. In the **Print** dialog box, click the **OK** button to print the job.

## Check the paper type setting (Mac OS X)

1. Click the **File** menu, and then click the **Print** option.
2. In the **Printer** menu, select the product.
3. By default, the print driver displays the **Copies & Pages** menu. Open the menus drop-down list, and then click the **Finishing** menu.

4. Select a type from the **Media Type** drop-down list.
5. Click the **Print** button.

## Check the toner-cartridge status

Follow these steps to check the estimated life remaining in the toner cartridges and if applicable, the status of other replaceable maintenance parts.

1. From the Home screen on the product control panel, scroll to and touch the [Administration](#) button.
2. Open the following menus:
  - [Reports](#)
  - [Configuration/Status Pages](#)
3. Select the [Supplies Status](#) option, and then touch the [Print](#) button to print the report.
4. Check the percent of life remaining for the toner cartridges and if applicable, the status of other replaceable maintenance parts.

Print quality problems can occur when using a toner cartridge that is at its estimated end of life. The supplies status page indicates when a supply level is very low. After an HP supply has reached the very low threshold, HP's premium protection warranty on that supply has ended.

The supply does not need to be replaced now unless the print quality is no longer acceptable. Consider having a replacement available to install when print quality is no longer acceptable.

If you determine that you need to replace a toner cartridge or other replaceable maintenance parts, the supplies status page lists the genuine HP part numbers.

5. Check to see if you are using a genuine HP cartridge.

A genuine HP toner cartridge has the words "HP" or "Hewlett-Packard" on it, or has the HP logo on it. For more information on identifying HP cartridges go to [www.hp.com/go/learnaboutsupplies](http://www.hp.com/go/learnaboutsupplies).

Hewlett Packard cannot recommend the use of non-HP supplies, either new or remanufactured. Because they are not HP products, HP cannot influence their design or control their quality. If you are using a refilled or remanufactured toner cartridge and are not satisfied with the print quality, replace the toner cartridge with a genuine HP toner cartridge.

## Print a cleaning page

Print a cleaning page to remove dust and excess toner from the fuser if you are having any of the following problems:

- Specks of toner are on the printed pages.
- Toner is smearing on the printed pages.
- Repeated marks occur on the printed pages.

Use the following procedure to print a cleaning page.

1. From the Home screen on the product control panel, scroll to and touch the [Device Maintenance](#) button.
2. Open the following menus:
  - [Calibration/Cleaning](#)
  - [Cleaning Page](#)
3. Touch the [Print](#) button to print the page.
4. The cleaning process can take several minutes. When it is finished, discard the printed page.

## Visually inspect the toner cartridge

1. Remove the toner cartridge from the product, and verify that the sealing tape has been removed.
2. Check the memory chip for damage.
3. Examine the surface of the green imaging drum on the toner cartridge.

---

 **CAUTION:** Do not touch the imaging drum. Fingerprints on the imaging drum can cause print-quality problems.

---

4. If you see any scratches, fingerprints, or other damage on the imaging drum, replace the toner cartridge.
5. If the imaging drum does not appear to be damaged, rock the toner cartridge gently several times and reinstall it. Print a few pages to see if the problem has resolved.

## Check paper and the printing environment

### Use paper that meets HP specifications

Use different paper if you are having any of the following problems:

- The printing is too light or seems faded in areas.
- Specks of toner are on the printed pages.
- Toner is smearing on the printed pages.
- Printed characters seem misformed.
- Printed pages are curled.

Always use a paper type and weight that this product supports. In addition, follow these guidelines when selecting paper:

- Use paper that is of good quality and free of cuts, nicks, tears, spots, loose particles, dust, wrinkles, voids, staples, and curled or bent edges.
- Use paper that has not been previously printed on.

- Use paper that is designed for use in laser printers. Do not use paper that is designed only for use in Inkjet printers.
- Use paper that is not too rough. Using smoother paper generally results in better print quality.

## Check the environment

Environmental conditions can directly affect print quality, and they are a common cause for paper-feeding problems. Try the following solutions:

- Move the product away from drafty locations, such as air-conditioning vents, or open windows or doors.
- Make sure the product is not exposed to temperatures or humidity outside of product specifications.
- Do not place the product in a confined space, such as a cabinet.
- Place the product on a sturdy, level surface.
- Remove anything that is blocking the vents on the product. The product requires good air flow on all sides, including the top.
- Protect the product from airborne debris, dust, steam, grease, or other elements that can leave residue inside the product.

## Check the EconoMode settings

HP does not recommend the full-time use of EconoMode. If EconoMode is used full-time, the toner supply might outlast the mechanical parts in the toner cartridge. If print quality begins to degrade and is no longer acceptable, consider replacing the toner cartridge.

---

 **NOTE:** This feature is available with the PCL 6 print driver for Windows. If you are not using that driver, you can enable the feature by using the HP Embedded Web Server.

---

Follow these steps if the entire page is too dark or too light.

1. From the software program, select the **Print** option.
2. Select the product, and then click the **Properties** or **Preferences** button.
3. Click the **Paper/Quality** tab, and locate the **Print Quality** area.
4. If the entire page is too dark, use these settings:
  - Select the **600 dpi** option.
  - Select the **EconoMode** check box to enable it.

If the entire page is too light, use these settings:

- Select the **FastRes 1200** option.
  - Clear the **EconoMode** check box to disable it.
5. Click the **OK** button to close the **Document Properties** dialog box. In the **Print** dialog, click the **OK** button to print the job.

## Try a different print driver

Try using a different print driver if you are printing from a software program and the printed pages have unexpected lines in graphics, missing text, missing graphics, incorrect formatting, or substituted fonts. The following print drivers are available at [www.hp.com/go/lj500MFP525\\_software](http://www.hp.com/go/lj500MFP525_software).

---

### HP PCL 6 driver

- Provided as the default driver on the product CD. This driver is automatically installed unless you select a different one.
- Recommended for all Windows environments
- Provides the overall best speed, print quality, and product-feature support for most users
- Developed to align with the Windows Graphic Device Interface (GDI) for the best speed in Windows environments
- Might not be fully compatible with third-party and custom software programs that are based on PCL 5

---

### HP UPD PS driver

- Recommended for printing with Adobe® software programs or with other highly graphics-intensive software programs
- Provides support for printing from postscript emulation needs, or for postscript flash font support

---

### HP UPD PCL 5

- Recommended for general office printing in Windows environments
- Compatible with previous PCL versions and older HP LaserJet products
- The best choice for printing from third-party or custom software programs
- The best choice when operating with mixed environments, which require the product to be set to PCL 5 (UNIX, Linux, mainframe)
- Designed for use in corporate Windows environments to provide a single driver for use with multiple product models
- Preferred when printing to multiple product models from a mobile Windows computer

---

### HP UPD PCL 6

- Recommended for printing in all Windows environments
  - Provides the overall best speed, print quality, and printer feature support for most users
  - Developed to align with Windows Graphic Device Interface (GDI) for best speed in Windows environments
  - Might not be fully compatible with third-party and custom software programs that are based on PCL 5
-



## Set the individual tray alignment

Adjust the alignment for individual trays when text or images are not centered or aligned correctly on the printed page.

1. From the Home screen on the product control panel, scroll to and touch the [Administration](#) button.
2. Open the following menus:
  - [General Settings](#)
  - [Print Quality](#)
  - [Image Registration](#)
3. Select the tray that you want to adjust.
4. Touch the arrow buttons on the screen to adjust the image in each direction for each side of the page.
5. Touch the [Print Test Page](#) button to verify the results, and then make further adjustments if necessary.
6. When you are satisfied with the results, touch the [Save](#) button to save the new settings.

# Improve copy quality

## Check the scanner glass for dirt or smudges

Over time, specks of debris might collect on the scanner glass and white plastic backing which can affect performance. Use the following procedure to clean the scanner glass and white plastic backing.

1. Press the power button to turn off the product, and then disconnect the power cable from the electrical outlet.

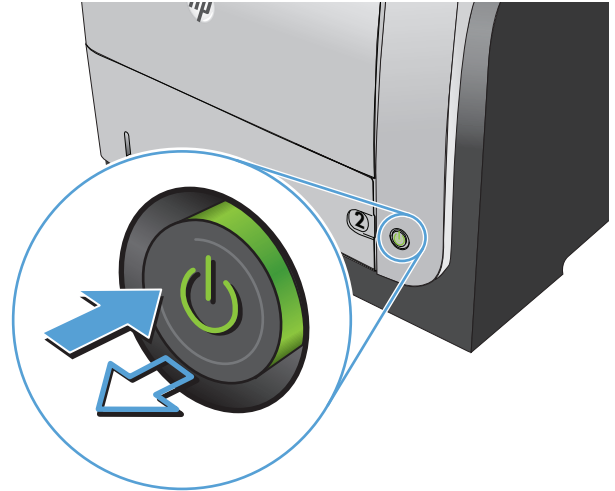

2. Open the scanner lid. Align paper that has copy defects with the scanner glass to identify the locations of dirt or smudges.

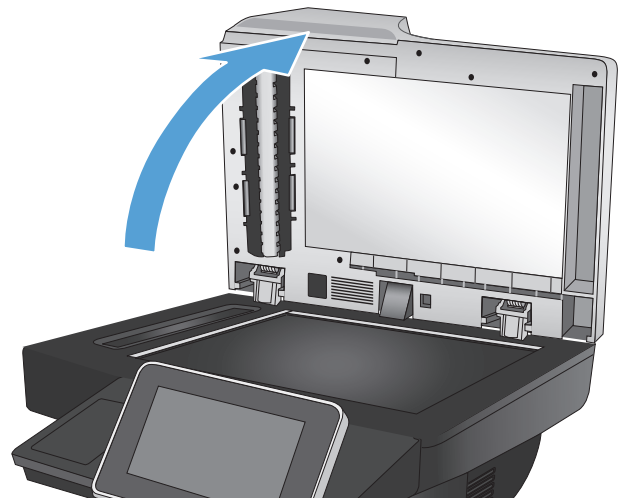

3. Clean the main scanner glass, the document-feeder glass (the small strip of glass on the left side of the scanner), and the white foam backing. Use a soft cloth or sponge that has been moistened with nonabrasive glass cleaner. Dry the glass and white plastic backing by using a chamois or a cellulose sponge to prevent spotting.

**CAUTION:** Do not use abrasives, acetone, benzene, ammonia, ethyl alcohol, or carbon tetrachloride on any part of the product; these can damage the product. Do not place liquids directly on the glass or platen. They might seep and damage the product.

**NOTE:** If you are having trouble with streaks on copies when you are using the document feeder, be sure to clean the small strip of glass on the left side of the scanner.

4. Connect the power cable to an outlet, and then press the power button to turn on the product.

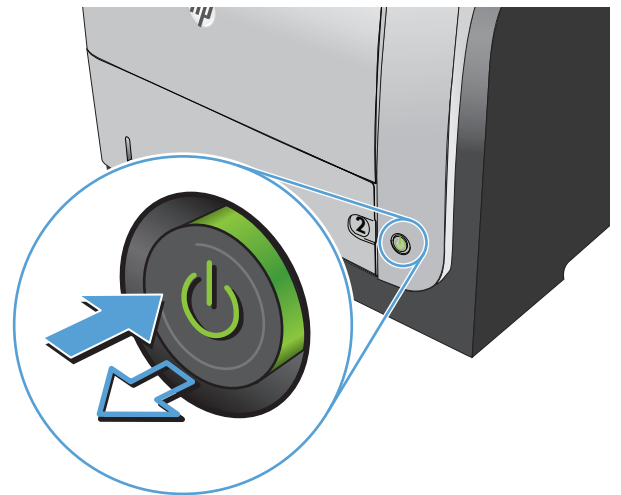
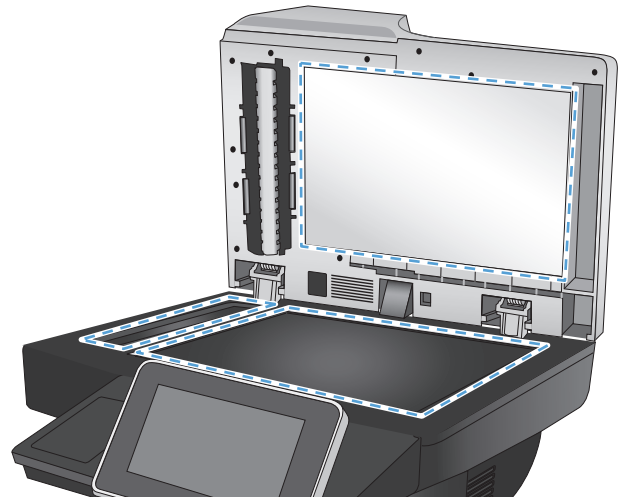

## Calibrate the scanner

If the copied image is not positioned correctly on the page, calibrate the scanner.

 **NOTE:** When using the document feeder, make sure to adjust the guides in the input tray so they are against the original document.

1. From the Home screen on the product control panel, scroll to and touch the [Device Maintenance](#) button.
2. Open the following menus:
  - [Calibration/Cleaning](#)
  - [Calibrate Scanner](#)

3. Touch the [Next](#) button to start the calibration process.
4. Wait while the product calibrates, and then try copying again.

## Check the paper settings

Check the paper settings if copied pages have smears, fuzzy or dark print, curled paper, scattered dots of toner, loose toner, or areas where toner has dropped out.

### Check the paper size and type configuration

1. From the Home screen on the product control panel, scroll to and touch the [Trays](#) button.
2. Touch the line for the tray that you want to configure, and then touch the [Modify](#) button.
3. Select the paper size and paper type from the lists of options.
4. Touch the [OK](#) button to save your selection.

### Select the tray to use for the copy

1. From the Home screen on the product control panel, touch the [Copy](#) button.
2. Touch the [Paper Selection](#) button.
3. Select the tray that holds the paper that you want to use, and then touch the [OK](#) button.

## Check the image-adjustment settings

Adjust these additional settings to improve copy quality.

1. From the Home screen on the product control panel, touch the [Copy](#) button.
2. Touch the [Image Adjustment](#) button.
3. Adjust the sliders to set the [Darkness](#) level, the [Contrast](#) level, the [Sharpness](#) level, and the [Background Cleanup](#) level. Touch the [OK](#) button.
4. Touch the Start  button.

## Optimize copy quality for text or pictures

Optimize the copy job for the type of image being copied: text, graphics, or photos.

1. From the Home screen on the product control panel, touch the [Copy](#) button.
2. Touch the [More Options](#) button, and then touch the [Optimize Text/Picture](#) button.
3. Select one of the predefined options, or touch the [Manually adjust](#) button and then adjust the slider in the [Optimize For](#) area. Touch the [OK](#) button.
4. Touch the Start  button.



**NOTE:** These settings are temporary. After you have finished the job, the product returns to the default settings.

## Edge-to-edge copying

Use this feature to avoid shadows that can appear along the edges of copies when the original document is printed close to the edges.

1. From the Home screen on the product control panel, scroll to and touch the **Administration** button.
2. Open the following menus:
  - **Copy Settings**
  - **Edge-To-Edge**
3. Select the **Edge-To-Edge output** option if the original document is printed close to the paper edges.
4. Touch the **OK** button.

## Clean the pickup rollers and separation pad in the document feeder

1. Lift the document-feeder latch.

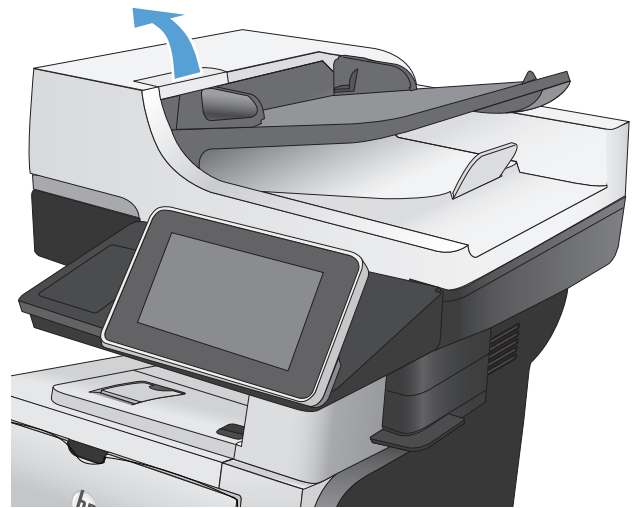

2. Open the document-feeder cover.

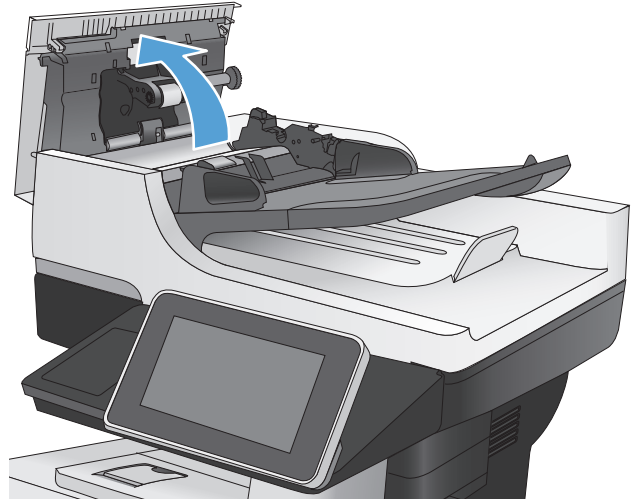

3. Remove any visible lint or dust from each of the feed rollers and the separation pad using compressed air or a clean lint-free cloth moistened with warm water.

**NOTE:** Lift up the roller assembly so you can clean the second roller.

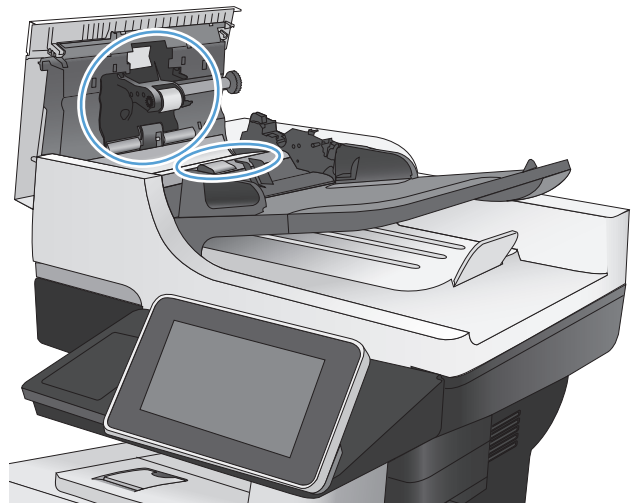

4. Close the document-feeder cover.

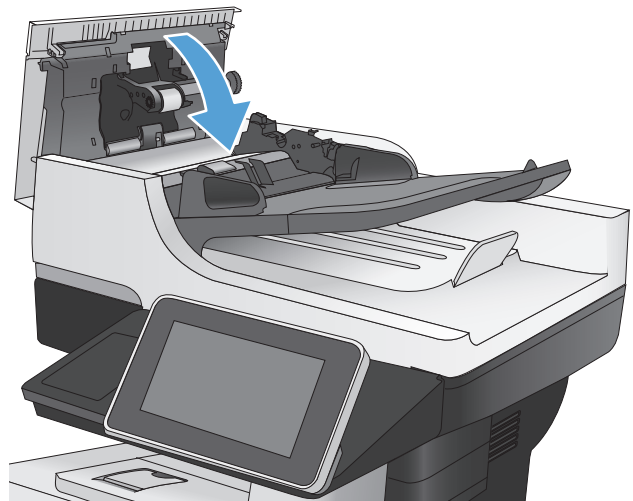

# Improve scan quality

## Check the scanner glass for dirt or smudges

Over time, specks of debris might collect on the scanner glass and white plastic backing which can affect performance. Use the following procedure to clean the scanner glass and white plastic backing.

1. Press the power button to turn off the product, and then disconnect the power cable from the electrical outlet.

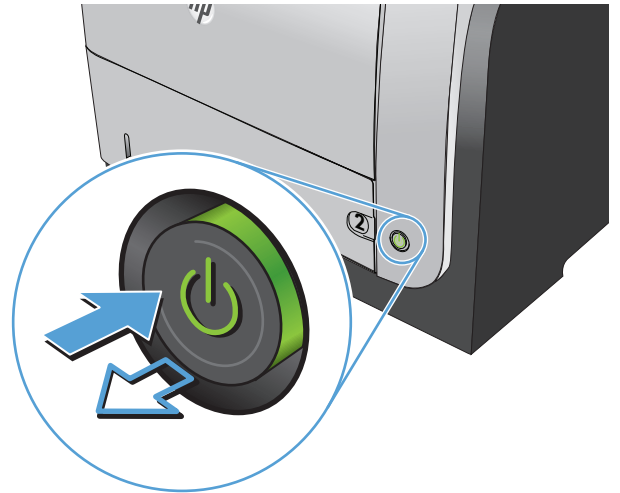

2. Open the scanner lid. Align paper that has copy defects with the scanner glass to identify the locations of dirt or smudges.

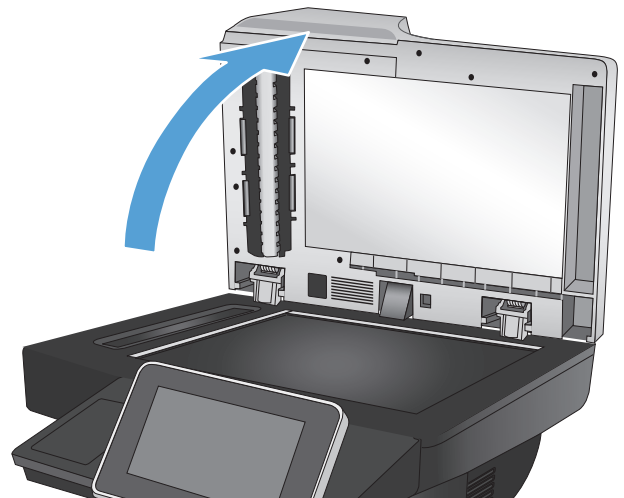

3. Clean the main scanner glass, the document-feeder glass (the small strip of glass on the left side of the scanner), and the white foam backing. Use a soft cloth or sponge that has been moistened with nonabrasive glass cleaner. Dry the glass and white plastic backing by using a chamois or a cellulose sponge to prevent spotting.

**CAUTION:** Do not use abrasives, acetone, benzene, ammonia, ethyl alcohol, or carbon tetrachloride on any part of the product; these can damage the product. Do not place liquids directly on the glass or platen. They might seep and damage the product.

**NOTE:** If you are having trouble with streaks on copies when you are using the document feeder, be sure to clean the small strip of glass on the left side of the scanner.

4. Connect the power cable to an outlet, and then press the power button to turn on the product.

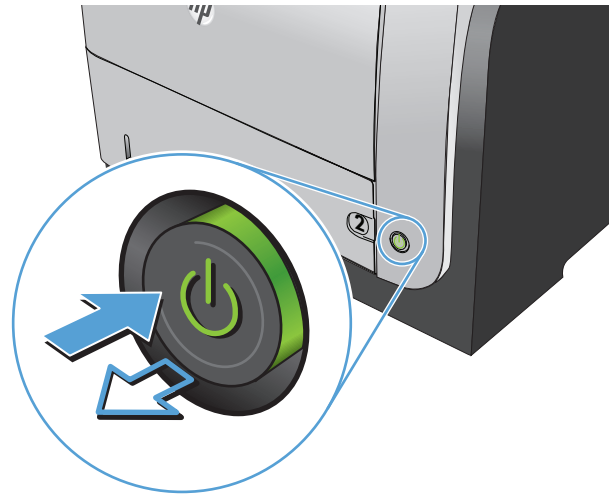
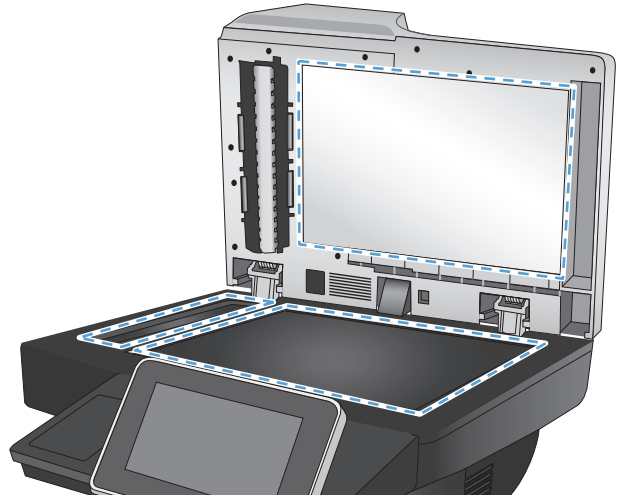

## Check the resolution settings

 **NOTE:** Setting the resolution to a high value increases the file size and the scan time.

1. From the Home screen on the product control panel, scroll to and touch the **Administration** button.
2. Open the **Scan/Digital Send Settings** menu.
3. Select the category of scan and send settings that you want to configure.
4. Open the **Default Job Options** menu.
5. Touch the **Resolution** button.
6. Select one of the predefined options. Touch the **OK** button.
7. Touch the Start  button.



## Check the image-adjustment settings

Adjust these additional settings to improve scan quality.

1. From the Home screen on the product control panel, scroll to and touch the [Administration](#) button.
2. Open the [Scan/Digital Send Settings](#) menu.
3. Select the category of scan and send settings that you want to configure.
4. Open the [Default Job Options](#) menu.
5. Touch the [Image Adjustment](#) button.
6. Adjust the sliders to set the [Darkness](#) level, the [Contrast](#) level, the [Sharpness](#) level, and the [Background Cleanup](#) level. Touch the [OK](#) button.
7. Touch the Start  button.

## Optimize scan quality for text or pictures

Optimize the scan job for the type of image being scanned: text, graphics, or photos.

1. From the Home screen on the product control panel, touch one of the buttons for the scan/send features:
  - [Save to Network Folder](#)
  - [Save to Device Memory](#)
  - [Save to USB](#)
2. Touch the [More Options](#) button, and then touch the [Optimize Text/Picture](#) button.
3. Select one of the predefined options, or touch the [Manually adjust](#) button and then adjust the slider in the [Optimize For](#) area. Touch the [OK](#) button.
4. Touch the Start  button.

---

 **NOTE:** These settings are temporary. After you have finished the job, the product returns to the default settings.

---

## Check the output-quality settings

This setting adjusts the level of compression when saving the file. For the highest quality, select the highest setting.

1. From the Home screen on the product control panel, scroll to and touch the [Administration](#) button.
2. Open the [Scan/Digital Send Settings](#) menu.
3. Select the category of scan and send settings that you want to configure.
4. Open the [Default Job Options](#) menu.
5. Touch the [Output Quality](#) button.

6. Select one of the predefined options. Touch the **OK** button.
7. Touch the Start  button.

## Clean the pickup rollers and separation pad in the document feeder

1. Lift the document-feeder latch.

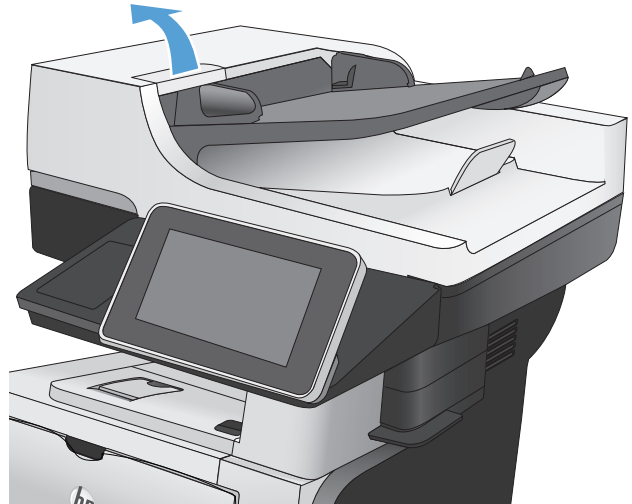

2. Open the document-feeder cover.

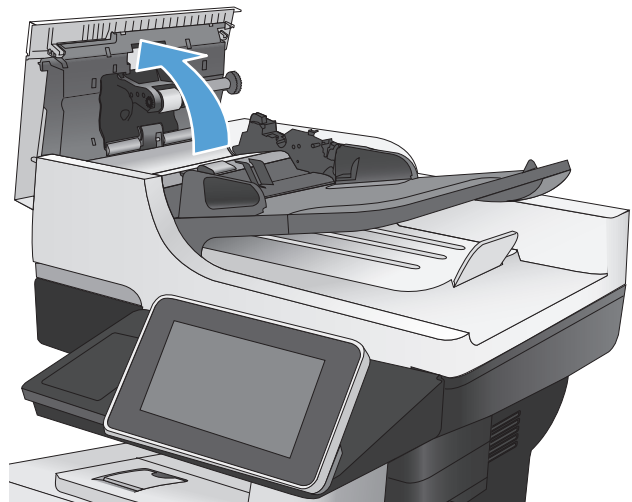

3. Remove any visible lint or dust from each of the feed rollers and the separation pad using compressed air or a clean lint-free cloth moistened with warm water.

**NOTE:** Lift up the roller assembly so you can clean the second roller.

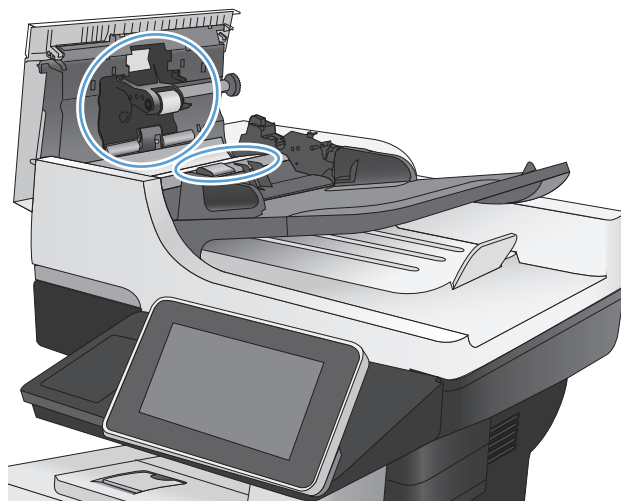

4. Close the document-feeder cover.

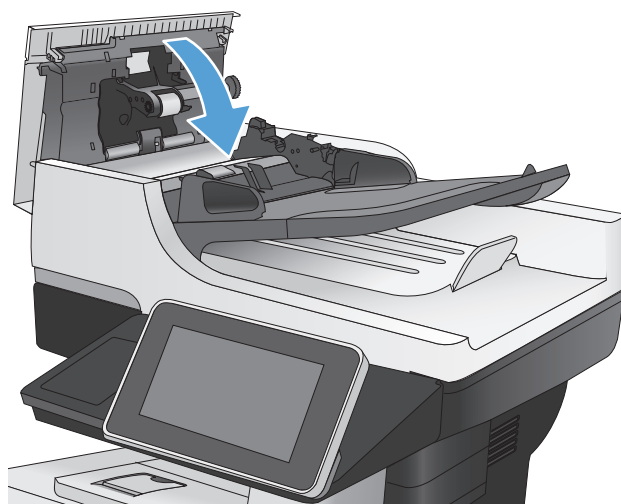

# Improve fax quality

## Check the scanner glass for dirt or smudges

Over time, specks of debris might collect on the scanner glass and white plastic backing which can affect performance. Use the following procedure to clean the scanner glass and white plastic backing.

1. Press the power button to turn off the product, and then disconnect the power cable from the electrical outlet.

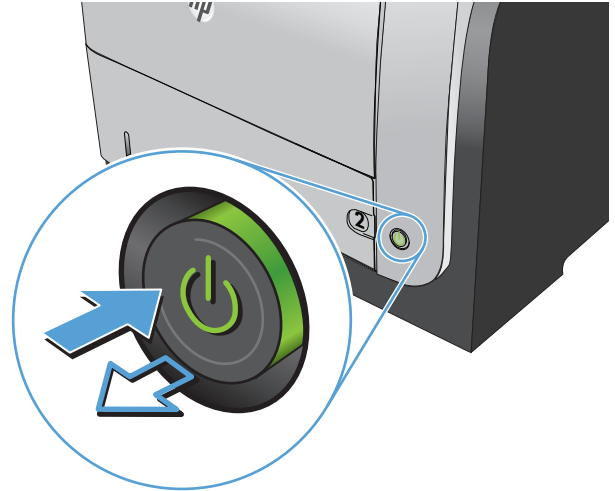

2. Open the scanner lid. Align paper that has copy defects with the scanner glass to identify the locations of dirt or smudges.

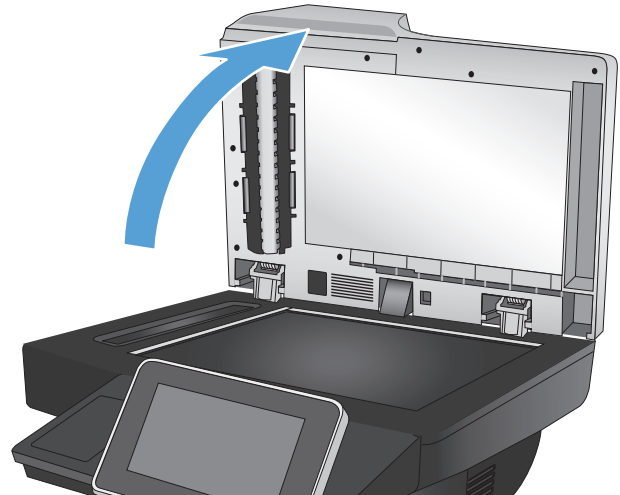

3. Clean the main scanner glass, the document-feeder glass (the small strip of glass on the left side of the scanner), and the white foam backing. Use a soft cloth or sponge that has been moistened with nonabrasive glass cleaner. Dry the glass and white plastic backing by using a chamois or a cellulose sponge to prevent spotting.

**CAUTION:** Do not use abrasives, acetone, benzene, ammonia, ethyl alcohol, or carbon tetrachloride on any part of the product; these can damage the product. Do not place liquids directly on the glass or platen. They might seep and damage the product.

**NOTE:** If you are having trouble with streaks on copies when you are using the document feeder, be sure to clean the small strip of glass on the left side of the scanner.

4. Connect the power cable to an outlet, and then press the power button to turn on the product.

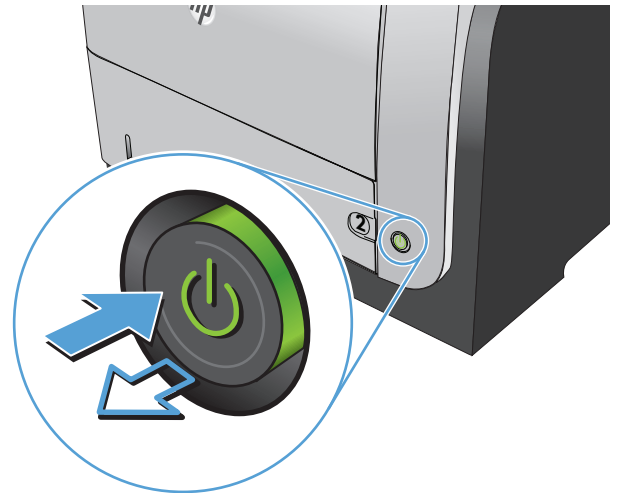
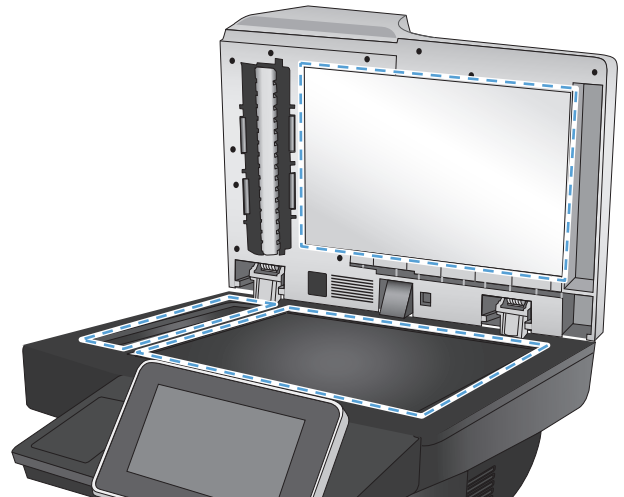

## Check the send-fax resolution settings

 **NOTE:** Increasing the resolution increases the fax size and send time.

1. From the Home screen on the product control panel, scroll to and touch the **Administration** button.
2. Open the following menus:
  - Fax Settings
  - Fax Send Settings
  - Default Job Options
3. Touch the **Resolution** button.

4. Select one of the predefined options. Touch the **OK** button.
5. Touch the Start  button.

## Check the image-adjustment settings

Adjust these additional settings to improve send-fax quality

1. From the Home screen on the product control panel, scroll to and touch the **Administration** button.
2. Open the following menus:
  - **Fax Settings**
  - **Fax Send Settings**
  - **Default Job Options**
3. Touch the **Image Adjustment** button.
4. Adjust the sliders to set the **Darkness** level, the **Contrast** level, the **Sharpness** level, and the **Background Cleanup** level. Touch the **OK** button.
5. Touch the Start  button.

## Optimize fax quality for text or pictures

Optimize the fax job for the type of image being scanned: text, graphics, or photos.

1. From the Home screen on the product control panel, touch the **Copy** button.
2. Touch the **More Options** button, and then touch the **Optimize Text/Picture** button.
3. Select one of the predefined options, or touch the **Manually adjust** button and then adjust the slider in the **Optimize For** area. Touch the **OK** button.
4. Touch the Start  button.



**NOTE:** These settings are temporary. After you have finished the job, the product returns to the default settings.

## Check the error-correction settings

The **Error Correction Mode** setting might be disabled, which can reduce image quality. Follow these steps to enable it.

1. From the Home screen on the product control panel, scroll to and touch the **Administration** button.
2. Open the following menus:
  - **Fax Settings**
  - **Fax Send Settings**

- [Fax Send Setup](#)
  - [General Fax Send Settings](#)
3. Select the [Error Correction Mode](#) option. Touch the [Save](#) button.

## Send to a different fax machine

Try sending the fax to a different fax machine. If the fax quality is better, the problem is related to the initial recipient's fax machine settings or supplies status.

## Clean the pickup rollers and separation pad in the document feeder

1. Lift the document-feeder latch.

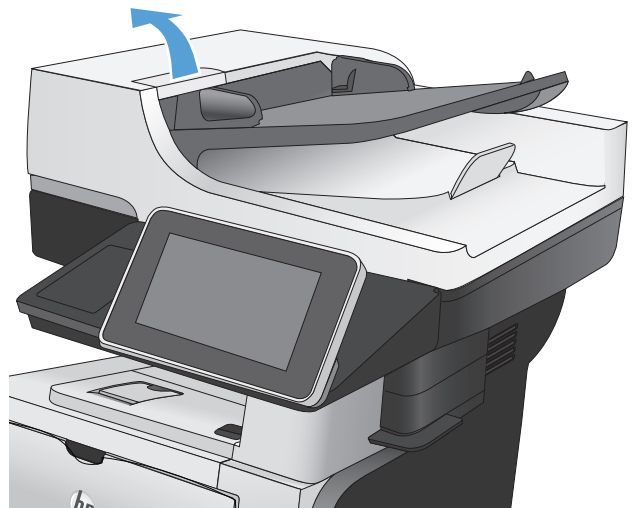

2. Open the document-feeder cover.

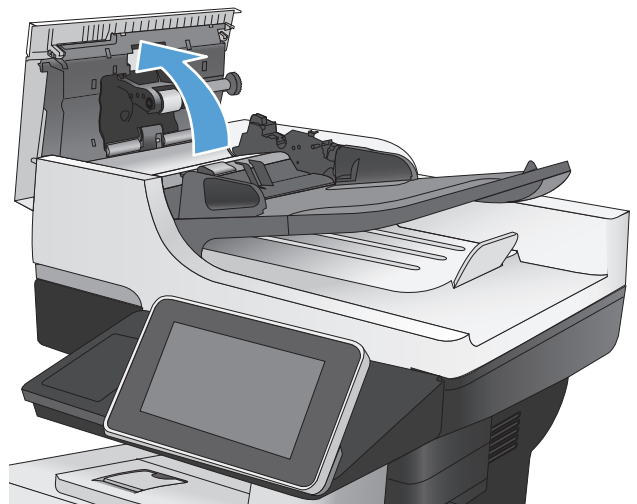

3. Remove any visible lint or dust from each of the feed rollers and the separation pad using compressed air or a clean lint-free cloth moistened with warm water.

**NOTE:** Lift up the roller assembly so you can clean the second roller.

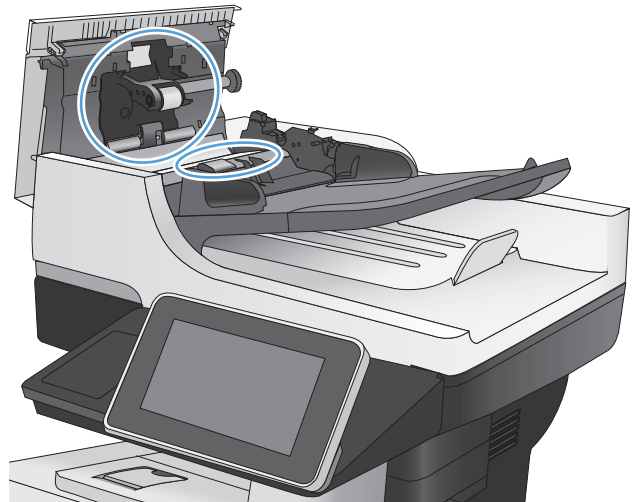

4. Close the document-feeder cover.

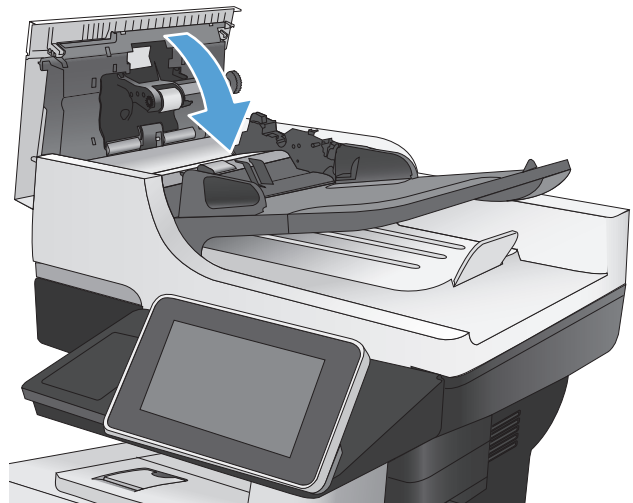

## Check the fit-to-page setting

If the [Fit to Page](#) setting is enabled, and the incoming fax is larger than the default page size, the product attempts to scale the image to fit the page. If this setting is disabled, larger images split across multiple pages.

1. From the Home screen on the product control panel, scroll to and touch the [Administration](#) button.
2. Open the following menus:
  - [Fax Settings](#)
  - [Fax Receive Settings](#)
  - [Default Job Options](#)
  - [Fit to Page](#)
3. Touch the [Enabled](#) option to enable the setting, or touch the [Disabled](#) option to disable it. Touch the [Save](#) button.



## Check the sender's fax machine

Ask the sender to try sending from a different fax machine. If the fax quality is better, the problem is with the sender's fax machine. If a different fax machine is unavailable, ask the sender to consider making the following changes:

- Make sure the original document is on white (not colored) paper.
- Increase the fax resolution, quality level, or contrast settings.
- If possible, send the fax from a computer software program.

# The product does not print or it prints slowly

## The product does not print

If the product does not print at all, try the following solutions.

1. Make sure the product is turned on and that the control panel indicates it is ready.
  - If the control panel does not indicate the product is ready, turn the product off and then on again.
  - If the control panel indicates the product is ready, try sending the job again.
2. If the control panel indicates the product has an error, resolve the error and then try sending the job again.
3. Make sure the cables are all connected correctly. If the product is connected to a network, check the following:
  - Check the light next to the network connection on the product. If the network is active, the light is green.
  - Make sure that you are using a network cable and not a phone cord to connect to the network.
  - Make sure the network router, hub, or switch is turned on and that it is working correctly.
4. Install the HP software from the CD that came with the product or use the UPD print driver. Using generic print drivers can cause delays clearing jobs from the print queue.
5. From the list of printers on your computer, right-click the name of this product, click **Properties**, and open the **Ports** tab.
  - If you are using a network cable to connect to the network, make sure the printer name listed on the **Ports** tab matches the product name on the product configuration page.
  - If you are using a USB cable and are connecting to a wireless network, make sure the box is checked next to **Virtual printer port for USB**.
6. If you are using a personal firewall system on the computer, it might be blocking communication with the product. Try temporarily disabling the firewall to see if it is the source of the problem.
7. If your computer or the product is connected to a wireless network, low signal quality or interference might be delaying print jobs.

## The product prints slowly

If the product prints, but it seems slow, try the following solutions.

1. Make sure the computer meets the minimum specifications for this product. For a list of specifications, go to this Web site: [www.hp.com/support/lj500MFPM525](http://www.hp.com/support/lj500MFPM525).
2. When you configure the product to print on some paper types, such as heavy paper, the product prints more slowly so it can correctly fuse the toner to the paper. If the paper type setting is not correct for the type of paper you are using, change the setting to the correct paper type.

# Solve easy-access USB printing problems

- [The Retrieve From USB Settings menu does not open when you insert the USB flash drive](#)
- [The file does not print from the USB flash drive](#)
- [The file that you want to print is not listed in the Retrieve from USB menu](#)

## The Retrieve From USB Settings menu does not open when you insert the USB flash drive

1. You must enable this feature before you can use it.
  - a. From the Home screen on the product control panel, scroll to and touch the [Administration](#) button.
  - b. Open the following menus:
    - [General Settings](#)
    - [Enable Retrieve from USB](#)
  - c. Select the [Enable](#) option, and then touch the [Save](#) button.
2. You might be using a USB flash drive or a file system that this product does not support. Save the files on a standard USB flash drive that uses File Allocation Table (FAT) file systems. The product supports FAT32 USB flash drives.
3. If another menu is already open, close that menu and then reinsert the USB flash drive.
4. The USB flash drive might have multiple partitions. (Some USB flash drive manufacturers install software on the accessory that creates partitions, similar to a CD.) Reformat the USB flash drive to remove the partitions, or use a different USB flash drive.
5. The USB flash drive might require more power than the product can provide.
  - a. Remove the USB flash drive.
  - b. Turn the product off and then on.
  - c. Use a USB flash drive that has its own power supply or that requires less power.
6. The USB flash drive might not be functioning correctly.
  - a. Remove the USB flash drive.
  - b. Turn the product off and then on.
  - c. Try printing from another USB flash drive.

## The file does not print from the USB flash drive

1. Make sure that paper is in the tray.
2. Check the control panel for messages. If paper is jammed in the product, clear the jam.

## The file that you want to print is not listed in the Retrieve from USB menu

1. You might be trying to print a file type that the USB printing feature does not support. The product supports .pdf, .prn, .pcl, .ps, and .cht file types.
2. You might have too many files in a single folder on the USB flash drive. Reduce the number of files in the folder by moving them to subfolders.
3. You might be using a character set for the file name that the product does not support. In this case, the product replaces the file names with characters from a different character set. Rename the files using ASCII characters.

## Solve USB connection problems

If you have connected the product directly to a computer, check the cable.

- Verify that the cable is connected to the computer and to the product.
- Verify that the cable is not longer than 2 m (6.65 ft). Try using a shorter cable.
- Verify that the cable is working correctly by connecting it to another product. Replace the cable if necessary.

# Solve wired network problems

Check the following items to verify that the product is communicating with the network. Before beginning, print a configuration page from the product control panel and locate the product IP address that is listed on this page.

- [The product has a poor physical connection.](#)
- [The computer is using the incorrect IP address for the product](#)
- [The computer is unable to communicate with the product](#)
- [The product is using incorrect link and duplex settings for the network](#)
- [New software programs might be causing compatibility problems](#)
- [The computer or workstation might be set up incorrectly](#)
- [The product is disabled, or other network settings are incorrect](#)

## The product has a poor physical connection.

1. Verify that the product is attached to the correct network port using a cable of the correct length.
2. Verify that cable connections are secure.
3. Look at the network port connection on the back of the product, and verify that the amber activity light and the green link-status light are lit.
4. If the problem continues, try a different cable or port on the hub.

## The computer is using the incorrect IP address for the product

1. Open the printer properties and click the **Ports** tab. Verify that the current IP address for the product is selected. The product IP address is listed on the product configuration page.
2. If you installed the product using the HP standard TCP/IP port, select the box labeled **Always print to this printer, even if its IP address changes.**
3. If you installed the product using a Microsoft standard TCP/IP port, use the hostname instead of the IP address.
4. If the IP address is correct, delete the product and then add it again.

## The computer is unable to communicate with the product

1. Test network communication by pinging the product.
  - a. Open a command-line prompt on your computer. For Windows, click **Start**, click **Run**, and then type `cmd`.
  - b. Type `ping` followed by the IP address for your product.
  - c. If the window displays round-trip times, the network is working.
2. If the ping command failed, verify that the network hubs are on, and then verify that the network settings, the product, and the computer are all configured for the same network.

## The product is using incorrect link and duplex settings for the network

Hewlett-Packard recommends leaving this setting in automatic mode (the default setting). If you change these settings, you must also change them for your network.

## New software programs might be causing compatibility problems

Verify that any new software programs are correctly installed and that they use the correct print driver.

## The computer or workstation might be set up incorrectly

1. Check the network drivers, print drivers, and the network redirection.
2. Verify that the operating system is configured correctly.

## The product is disabled, or other network settings are incorrect

1. Review the configuration page to check the status of the network protocol. Enable it if necessary.
2. Reconfigure the network settings if necessary.



# Solve fax problems

## Checklist for solving fax problems

Use the following checklist to help identify the cause of any fax-related problems you encounter:

- **Are you using the fax cable supplied with the fax accessory?** This fax accessory has been tested with the supplied fax cable to meet RJ11 and functional specifications. Do not substitute another fax cable; the analog-fax accessory requires an analog-fax cable. It also requires an analog phone connection.
- **Is the fax/phone line connector seated in the outlet on the fax accessory?** Make sure that the phone jack is correctly seated in the outlet. Insert the connector into the outlet until it "clicks."
- **Is the phone wall jack working properly?** Verify that a dial tone exists by attaching a phone to the wall jack. Can you hear a dial tone, and can you make or receive a phone call?

## What type of phone line are you using?

- **Dedicated line:** A standard analog fax/phone line assigned to receive or send faxes.

---

 **NOTE:** The phone line should be for product fax use only and not shared with other types of telephone devices. Examples include alarm systems that use the phone line for notifications to a monitoring company.

---

- **PBX system:** A business-environment phone system. Standard home phones and the fax accessory use an analog phone signal. Some PBX systems are digital and might not be compatible with the fax accessory. You need to have access to a standard analog phone connection to be able to send and receive faxes.
- **Roll-over lines:** A phone system feature where a new call "rolls over" to the next available line when the first incoming line is busy. Try attaching the product to the first incoming phone line. The fax accessory answers the phone after it rings the number of times set in the rings-to-answer setting.

---

 **NOTE:** Roll-over lines can cause problems with receiving faxes. Using roll-over lines with this product is not recommended.

---

 **NOTE:** Roll-over lines can cause problems with receiving faxes. Using roll-over lines with this product is not recommended.

---

## Are you using a surge-protection device?

A surge-protection device can be used between the wall jack and the fax accessory to protect the fax accessory against electrical power passed through the phone lines. These devices can cause some fax communication problems by degrading the quality of the phone signal. If you are having problems sending or receiving faxes and are using one of these devices, connect the product directly to the phone jack on the wall to determine whether the problem is with the surge-protection device.

## Are you using a phone company voice-messaging service or an answering machine?

If the rings-to-answer setting for the messaging service is lower than the rings-to-answer setting for the fax accessory, the messaging service answers the call, and the fax accessory cannot receive faxes. If the rings-to-answer setting for the fax accessory is lower than that of the messaging service, the fax accessory answers all calls.

## Does your phone line have a call-waiting feature?

If the fax telephone line has an activated call-waiting feature, a call-waiting notice can interrupt a fax call in progress, which causes a communication error. Ensure that a call-waiting feature is not active on the fax telephone line.

## Check fax accessory status

If the analog-fax accessory does not appear to be functioning, print a [Configuration Page](#) report to check the status.

1. From the Home screen, scroll to and touch the [Administration](#) button.
2. Open the following menus:
  - [Reports](#)
  - [Configuration/Status Pages](#)
  - [Configuration Page](#)
3. Touch the [Print](#) button to print the report, or touch the [View](#) button to view the report on the screen. The report consists of several pages.

---

 **NOTE:** The product IP address or host name is listed on the Jetdirect Page.

---

On the Fax Accessory Page of the Configuration Page, under the Hardware Information heading, check the Modem Status. The following table identifies the status conditions and possible solutions.

 **NOTE:** If the Fax Accessory Page does not print, there might be a problem with the analog fax accessory. If you are using LAN fax or Internet fax, those configurations could be disabling the feature.

---

Operational / Enabled <sup>1</sup>	The analog-fax accessory is installed and ready.
Operational / Disabled <sup>1</sup>	The fax accessory is installed, but you have not configured the required fax settings yet.  The fax accessory is installed and operational; however, the HP Digital Sending utility has either disabled the product fax feature or has enabled LAN fax. When LAN fax is enabled, the analog-fax feature is disabled. Only one fax feature, either LAN fax or analog fax, can be enabled at a time.

**NOTE:** If LAN fax is enabled, the [Fax](#) feature is unavailable on the product control panel.

---

Non-Operational / Enabled/Disabled <sup>1</sup>	The product has detected a firmware failure. Upgrade the firmware.
Damaged / Enabled/Disabled <sup>1</sup>	The fax accessory has failed. Reseat the fax accessory card and check for bent pins. If the status is still DAMAGED, replace the analog-fax accessory card.

<sup>1</sup> ENABLED indicates that the analog-fax accessory is enabled and turned on; DISABLED indicates that LAN fax is enabled (analog fax is turned off).

## General fax problems

Problem	Cause	Solution
The fax failed to send.	JBIG is enabled, and the receiving fax machine does not have JBIG capability.	Turn off the JBIG setting.
An "Out of Memory" status message displays on the product control panel.	The product storage disk is full.	Delete some stored jobs from the disk. From the Home screen on the product control panel, touch the <a href="#">Retrieve from Device Memory</a> button. Open the list of stored jobs or stored faxes. Select a job to delete, and then touch the <a href="#">Delete</a> button.
Print quality of a photo is poor or prints as a gray box.	You are using the wrong page-content setting or the wrong resolution setting.	Try setting the <a href="#">Optimize Text/Picture</a> option to <a href="#">Photograph</a> setting.
You touched the Stop  button on the product control panel to cancel a fax transmission, but the fax was still sent.	If the job is too far along in the sending process, you cannot cancel the job.	This is normal operation.
No fax address book button displays.	The fax address book feature has not been enabled.	Use the HP MFP Digital Sending Software Configuration utility to enable the fax address book feature.
Not able to locate the Fax settings in HP Web Jetadmin.	Fax settings in HP Web Jetadmin are located under the device's status page drop-down menu.	Select <b>Digital Sending and Fax</b> from the drop-down menu.
The header is appended to the top of the page when the overlay option is enabled.	For all forwarded faxes, the product appends the overlay header to the top of a page.	This is normal operation.
A mix of names and numbers is in the recipients box.	Names and numbers can both display, depending on where they are from. The fax address book lists names, and all other databases list numbers.	This is normal operation.
A one-page fax prints as two pages.	The fax header is being appended to the top of the fax, pushing text to a second page.	To print a one page fax on one page, set the overlay header to overlay mode, or adjust the fit-to-page setting.
A document stops in the document feeder in the middle of faxing.	A jam is in the document feeder.	Clear the jam, and send the fax again.
The volume for sounds coming from the fax accessory is too high or too low.	The volume setting needs to be adjusted.	Adjust the volume in the <a href="#">Fax Send Settings</a> menu and the <a href="#">Fax Receive Settings</a> menu.

## Use Fax over VoIP networks

VoIP technology converts the analog phone signal into digital bits. These are then assembled into packets which travel on the Internet. The packets are converted and transmitted back to analog signals at or near the destination.

Transmission of information on the Internet is digital instead of analog. Therefore, there are different constraints on the fax transmission that might require different fax settings than the analog Public Switched Telephone Network (PSTN). Fax is very dependent upon timing and signal quality, so a fax transmission is more sensitive to a VoIP environment.

### The following are suggested changes in settings for the HP LaserJet Analog Fax Accessory 500 when it is connected to a VoIP service:

- Begin with the fax speed set in Fast (V.34) mode and with Error Correction Mode (ECM) turned on. The V.34 protocol handles any changes in transmission speed needed to accommodate VoIP networks.
- If numerous errors or retries occur with the fax speed set to Fast, set it to Medium (V.17).
- If errors and retries persist, set the fax speed to Slow (V.29) because some VoIP systems cannot handle the higher signal rates associated with fax.
- In rare cases, if errors persist, turn off ECM on the product. The image quality might decrease. Ensure that the image quality is acceptable with ECM off before using this setting.
- If the preceding setting changes have not improved the VoIP fax reliability, contact your VoIP provider for help.

## Problems with receiving faxes

Problem	Cause	Solution
Incoming fax calls are not being answered by the fax accessory (no fax detected).	The rings-to-answer setting might not be set correctly.	Check the rings-to-answer setting.
	The fax cable might not be connected correctly, or the fax cable is not working.	Check the installation. Make sure you are using the fax cable that came with the product or with the fax accessory.
	The phone line might not be working.	Disconnect the fax accessory from the phone jack, and then connect a phone. Try to make a phone call to ensure the phone line is working.
	If you are using a PBX system, the ring signals might not be configured correctly.	Check the ring-signal configuration on the PBX system.

Problem	Cause	Solution
	A voice-messaging service might be interfering with incoming faxes.	Do one of the following: <ul style="list-style-type: none"> <li>Discontinue the messaging service.</li> <li>Use a phone line dedicated to fax calls.</li> <li>Decrease the rings-to-answer for the fax accessory to a number less than the rings-to-answer for the voice mail.</li> </ul>
Faxes are being received very slowly.	You might be receiving a complex fax, such as one with many graphics.	Complex faxes take longer to transmit.
	The sending fax machine might have a slow modem speed.	The fax accessory only receives the fax at the fastest modem speed the sending fax machine can use. Wait for the fax transmission to complete.
	The resolution at which the fax was sent or is being received is very high. A higher resolution typically results in better quality, but also requires a longer transmission time.	Ask the sender to decrease the resolution and resend the fax.
	If there is a poor phone-line connection, the fax accessory and the sending fax machine slow down the transmission to adjust for errors.	Ask the sender to resend the fax. Ask the phone company to check the phone line.
Faxes are not printing on the product.	No paper is in the input tray.	Load paper. Any faxes received while the input tray is empty are stored and will print after the tray has paper.
	The <a href="#">Fax Printing Schedule</a> feature is in use.	Faxes print according to the schedule. To print faxes immediately, disable the <a href="#">Fax Printing Schedule</a> feature.
	The product is either low on toner or has run out of toner.	If configured, the product stops printing as soon as it is low on toner or runs out of toner. Any faxes received are stored in memory and print after the toner has been replaced.
	The incoming call might be a voice call.	Incoming voice calls usually show up in the call report as a <b>No Fax Detected</b> error. Because these are voice calls and not a fax error, no action is necessary.
	The incoming fax was interrupted.	Verify that the fax telephone line does not have an activated call-waiting feature. A call-waiting notice can interrupt a fax call in progress, which causes a communication error.
	The <a href="#">Fax Printing Schedule</a> feature is set to the <a href="#">Always store faxes</a> option.	Change the <a href="#">Fax Printing Schedule</a> setting to the <a href="#">Always print faxes</a> option.

## Problems with sending faxes

Problem	Cause	Solution
Faxes are transmitting very slowly.	You might be sending a complex fax, such as one with many graphics.	Complex faxes take longer to transmit.
	The receiving fax machine might have a slow modem speed.	The fax accessory only sends the fax at the fastest modem speed the receiving fax machine can use. Wait for the fax transmission to complete.
	The resolution at which the fax was sent or is being received is very high. A higher resolution typically results in better quality, but also requires a longer transmission time.	Decrease the resolution and change the <a href="#">Optimize Text/Picture</a> option.
	If there is a poor phone-line connection, the fax accessory and the receiving fax machine slow down the transmission to adjust for errors.	Cancel and resend the fax. Ask the phone company check the phone line.
Faxes quit during sending.	The document might have a gray background, which can increase fax transmission time.	Use the <a href="#">Image Adjustment</a> feature to clean up the background shading.
	The receiving fax machine might be malfunctioning.	Try sending to another fax machine.
	The phone line might not be working.	Disconnect the fax accessory from the phone jack, and connect a phone. Try to make a phone call to ensure the phone line is working.
	The phone line might be noisy or poor quality.	Try using a slower fax speed to improve the reliability of transmission. Use the <a href="#">Fax Dialing Settings</a> menu to set the fax speed for sending faxes.
The fax accessory is receiving faxes but is not sending them.	A call-waiting feature might be active.	Verify that the fax telephone line does not have an activated call-waiting feature. A call-waiting notice can interrupt a fax call in progress, which causes a communication error.
	If the fax accessory is on a PBX system, the PBX system might be generating a dial tone the fax accessory cannot detect.	Disable the detect-dial-tone setting.
	There might be a poor phone connection.	Try again later.
	The receiving fax machine might be malfunctioning.	Try sending to another fax machine.
	The phone line might not be working.	Disconnect the fax accessory from the phone jack, and connect a phone. Try to make a phone call to ensure the phone line is working.

Problem	Cause	Solution
Outgoing fax calls keep dialing.	The fax accessory automatically redials a fax number if the <a href="#">Redial On Busy</a> option is on or if the <a href="#">Redial On No Answer</a> option is on.	This is normal operation. If you do not want the fax to retry, set the <a href="#">Redial On Busy</a> option to 0, set the <a href="#">Redial On No Answer</a> option to 0, and set the <a href="#">Redial on error</a> option to 0.
Faxes you send are not arriving at the receiving fax machine.	The receiving fax machine might be turned off or might have an error condition, such as being out of paper.	Ask the recipient to make sure the fax machine is turned on and ready to receive faxes.
	A fax might be in memory because it is waiting to redial a busy number, or there are other jobs ahead of it waiting to be sent.	If a fax job is in memory for either of these reasons, an entry for the job displays in the fax log. Print the fax activity log, and check the <b>Result</b> column for jobs with a <b>Pending</b> designation.

## Fax error codes

If a fax problem occurs which prevents or interrupts fax transmission, an error code is generated that can help in determining the cause of the problem. Error codes show up in the fax activity log, the fax call report, and the T.30 Protocol Trace. Print one of these reports to obtain the error code. A detailed description of the error codes and the appropriate action is available at [www.hp.com](http://www.hp.com). Search for HP LaserJet Analog Fax Accessory 500.

## Fax error messages on the product control panel

If the fax process is interrupted or an error occurs during a fax transmission or reception, a two-part status/error description is generated by the fax subsystem on the product. Normal or successful faxes also generate messages indicating success. The message information consists of a text description and a numeric code (a few messages do not include numeric codes). Only the text part of the message is displayed on the product control panel; however, both the text message and numeric code are listed in the Fax Activity Report, Fax Call Report, and the Fax T.30 Trace. The numeric code is shown in parentheses after the text part of the message in the reports.

The fax modem generates the numeric code. Usually a numeric code of (0) indicates a normal modem response. Some messages always display a numeric code of (0), other messages can have a range of numeric codes, and a few messages have no numeric code. Usually a numeric code of (0) indicates an error was not associated with the fax modem, but occurred in another part of the fax system or other product system such as the printing system. Non-zero error codes give further detail into the particular action or process that the modem is executing, and they do not necessarily indicate that there is a problem with the modem.

Persistent error messages with numeric codes different than those listed here require assistance of customer support. Print a Fax T.30 Trace report before contacting customer support to help identify the problem. This report contains details of the last fax call.

1. From the Home screen on the product control panel, scroll to and touch the [Administration](#) button.
2. Open the following menus:
  - [Troubleshooting](#)
  - [Fax](#)
  - [Fax T.30 Trace](#)
3. Select the [Print T.30 Report](#) option to print the report.



## Send-fax messages

**Table 10-1 Send-fax messages**

Message	Error No.	Description	Action
<b>Cancelled</b>	0	Someone cancelled the fax at the product control panel.	None.
<b>Success</b>	n/a	The fax was sent successfully.	None.
<b>Fail Busy</b>	0	The receiving fax machine is busy.	The fax will be retired automatically (if configured), otherwise try resending fax later.
<b>No Answer</b>	0 or 17	The receiving fax machine is not answering the call, or a person answered the call.	The receiving fax machine might be disconnected or turned off; contact the receiver to check the machine. Try resending.
<b>No Dial Tone</b>	0	No dial tone is detected when sending the fax.	Verify the phone line is active; set the sending fax to "not" to detect a dial tone.
<b>Failed</b>	Any	The fax might be corrupted or not sent.	Try resending fax.
<b>Failed</b>	0	Incompatible page width, or page had too many bad lines.	Try resending fax; if the error persists, contact service.
<b>Failed</b>	17 or 36	Lost telephone connection between sender and receiver. The issue might be due to voice calls interrupting the fax, or a person answering the call.	Try resending the fax.
<b>Failed or Communication Error</b>	Any besides 17 or 36	General communications issue where the fax transmission was interrupted or did not proceed as expected.	Try resending fax; if the error persists, contact support.
<b>Space Fail</b>	0	Unable to read or write the fax image file to disk; could be corrupt product disk or no space available on the product's disk.	Try resending fax; if the error persists, contact support.
<b>Memory Error</b>	0	Out of memory on product.	If the error persists, delete items from the product memory, such as stored jobs or saved faxes.
<b>Power Failure</b>	0	A power failure occurred on the sending fax product during the fax transmission.	Try resending the fax.

## Receive-fax messages

**Table 10-2 Receive-fax messages**

Message	Error No.	Description	Action
<b>Success</b>	n/a	The fax transmission was successful.	None.
<b>Blocked</b>	n/a	The receiving fax machine is using the blocked-number feature and is blocking this fax.	None.
<b>Failed</b>	Any	The fax might be corrupted or not sent.	Ask the sender to resend the fax; if the error persists, contact support.
<b>Failed</b>	0	Incompatible page width or page had too many bad lines.	Ask the sender to resend the fax; if the error persists, contact support.
<b>Failed</b>	17, 36	Lost telephone connection or interruption between sender/receiver.	Ask the sender to resend the fax (if the sending machine does not automatically retry).
<b>Failed</b>	Any besides 17 or 36	General communications issue where the fax transmission was interrupted or did not proceed as expected.	Ask the sender to resend the fax; if the error persists, contact support.
<b>Space Fail</b>	0	Unable to read or write image file to disk; could be corrupt product disk or no space on disk.	Ask the sender to resend the fax; if the error persists, contact support.
<b>Memory Error</b>	0	Out of memory on product.	If the error persists, delete items from the product memory, such as stored jobs or saved faxes.
<b>Print Fail</b>	0	The received image file cannot be decoded.	Ask the sender to resend the fax; enable Error Correction Mode if it is not already enabled.
<b>Power Failure</b>	0	A power failure occurred during the fax reception.	Ask the sender to resend the fax.
<b>No Fax Detected</b>	17, 36	A voice call was made to the fax.	None

## Service settings

These items in the control-panel menus are intended to be used when an HP service representative is assisting you.

## Settings in the Troubleshooting menu

1. From the Home screen on the product control panel, scroll to and touch the [Administration](#) button.
2. Open the following menus:
  - [Troubleshooting](#)
  - [Fax](#)

---

<a href="#">Fax T.30 Trace</a>	This is a printed report of all the communications between the sending and receiving fax machines for the last Fax transmission or reception. The report contains detailed error codes and other information that might be useful in troubleshooting a particular problem related to sending or receiving a fax. Print this report before contacting HP customer support.
<a href="#">Fax V.34</a>	This setting controls the modem's method of transmission. The <a href="#">Normal</a> setting allows the modem to select any of the supported fax speeds up to 33,600 bps. The <a href="#">Off</a> setting sets the fax speed to 14,400 bps or lower, depending on the speed settings for sending and receiving.
<a href="#">Fax Speaker Mode</a>	In <a href="#">Normal</a> mode, the modem speaker is turned on during dialing, through the initial connection, and then it turns off. In <a href="#">Diagnostic</a> mode, the speaker is turned on and remains on for all fax communications until the setting is returned to <a href="#">Normal</a> mode.
<a href="#">Fax Log Entries</a>	The <a href="#">Standard</a> fax log includes basic information such as the time and whether the fax was successful. The <a href="#">Detailed</a> fax log shows the intermediate results of the redial process not shown in the <a href="#">Standard</a> fax log.

---

# Solve product software problems (Windows)

## A print driver for the product is not visible in the Printer folder

1. Reinstall the product software.

 **NOTE:** Close any applications that are running. To close an application that has an icon in the system tray, right-click the icon, and select **Close** or **Disable**.

2. Try connecting the USB cable to a different USB port on the computer.

## An error message was displayed during the software installation

1. Reinstall the product software.

 **NOTE:** Close any applications that are running. To close an application that has an icon in the system tray, right-click the icon, and select **Close** or **Disable**.

2. Check the amount of free space on the drive where you are installing the product software. If necessary, free up as much space as you can, and reinstall the product software.
3. If necessary, run the Disk Defragmenter, and reinstall the product software.

## The product is in Ready mode, but nothing prints

1. Print a configuration page, and verify the product functionality.
2. Verify that all of the cables are correctly seated and within specifications. This includes the USB and power cables. Try a new cable.
3. Verify that the product IP address listed on the configuration page matches the IP address for the software port. Use one of the following procedures:

### Windows XP, Windows Server 2003, Windows Server 2008, and Windows Vista

- a. Click **Start**, or for Windows Vista click the Windows icon in the lower-left corner of the screen.
- b. Click **Settings**.
- c. Click **Printers and Faxes** (using the default Start menu view) or click **Printers** (using the Classic Start menu view).
- d. Right-click the product driver icon, and then select **Properties**.
- e. Click the **Ports** tab, and then click **Configure Port**.
- f. Verify the IP address, and then click **OK** or **Cancel**.
- g. If the IP addresses are not the same, delete the driver, and reinstall the driver using the correct IP address.

## Windows 7

- a. Click the Windows icon in the lower-left corner of the screen.
- b. Click **Devices and Printers**.
- c. Right-click the product driver icon, and then select **Printer properties**.
- d. Click the **Ports** tab, and then click **Configure Port**.
- e. Verify the IP address, and then click **OK** or **Cancel**.
- f. If the IP addresses are not the same, delete the driver, and reinstall the driver using the correct IP address.

# Solve product software problems (Mac OS X)

- [The product name does not appear in the product list in the Print & Fax or the Print & Scan list](#)
- [A print job was not sent to the product that you wanted](#)
- [When connected with a USB cable, the product does not appear in the Print & Fax or the Print & Scan list after the driver is selected](#)

## The product name does not appear in the product list in the Print & Fax or the Print & Scan list

1. Make sure that the cables are connected correctly and the product is on.
2. Print a configuration page to check the product name. Verify that the name on the configuration page matches the product name in the Print & Fax or the Print & Scan list.
3. Replace the USB or network cable with a high-quality cable.
4. If necessary, reinstall the software.

---

 **NOTE:** Connect the USB or network cable before attempting to reinstall the software.

---

## A print job was not sent to the product that you wanted

1. Open the print queue and restart the print job.
2. Another product with the same or similar name might have received your print job. Print a configuration page to check the product name. Verify that the name on the configuration page matches the product name in the Print & Fax or the Print & Scan list.

## When connected with a USB cable, the product does not appear in the Print & Fax or the Print & Scan list after the driver is selected

### Software troubleshooting

- ▲ Make sure that your Mac operating system is Mac OS X 10.5 or later.

### Hardware troubleshooting

1. Make sure that the product is turned on.
2. Make sure that the USB cable is connected correctly.
3. Make sure that you are using the appropriate high-speed USB cable.

4. Make sure that you do not have too many USB devices drawing power from the chain. Disconnect all of the devices from the chain, and connect the cable directly to the USB port on the computer
5. Check to see if more than two non-powered USB hubs are connected in a row on the chain. Disconnect all of the devices from the chain, and then connect the cable directly to the USB port on the computer.



**NOTE:** The iMac keyboard is a non-powered USB hub.

---

# Remove software (Windows)

## Windows XP

1. Click **Start, Control Panel**, and then **Add or Remove Programs**.
2. Find and select the product from the list.
3. Click the **Change/Remove** button to remove the software.

## Windows Vista

1. Click the Windows icon in the lower-left corner of the screen. Click **Control Panel**, and then click **Programs and Features**.
2. Find and select the product from the list.
3. Select the **Uninstall/Change** option.

## Windows 7

1. Click the Windows icon in the lower-left corner of the screen. Click **Control Panel**, and then under the **Programs** heading, click **Uninstall a program**.
2. Find and select the product from the list.
3. Select the **Uninstall** option.



## Remove the print driver (Mac OS X)

You must have administrator rights to remove the software.

1. Open **System Preferences**.
2. Select **Print & Fax**.
3. Highlight the product.
4. Click the minus (-) symbol.
5. Delete the print queue, if necessary.



# Index

## A

- accessories
  - ordering 36
- activity log 175
- address books, email
  - recipient lists 140
  - recipient lists, creating 138
- adjust copy images 114
- administration menu map
  - description 9
- AirPrint 93
- alternative letterhead mode 25
- anticounterfeit supplies 38

## B

- billing code report
  - printing 176
- billing codes 152
- billing codes report
  - description 10
- bins, output
  - locating 2
  - selecting 32
- blank pages
  - placing between print jobs 90
- blocked fax list
  - description 10
- blocked fax list report
  - printing 176
- Bonjour
  - identifying 180
- booklets
  - creating (Windows) 77
  - printing (Mac) 81
- books
  - copying 118
- both sides, copying 108, 109
- both sides, copying manually
  - duplex, manual 109

- browser requirements
  - HP embedded Web Server 180

## C

- calibrate
  - scanner 233
- call report 176
- canceling a fax 174
- canceling a print request (Mac OS X) 84
- canceling a print request (Windows) 82
- card stock
  - output bin, selecting 32
- cartridges
  - non-HP 37, 46
  - order numbers 46
  - recycling 46
  - replacing 47
  - storage 46
- checklist
  - problems 198
- cleaning
  - control panel 7
  - paper path 227
  - rollers 235, 240, 245
  - scanner glass 232, 237, 242
- clear jams 205
- collate
  - copy jobs 106
- configuration page
  - description 9
- configuring
  - IP address 13, 16
- connection
  - USB with Mac 15
  - USB with Windows 12

- control panel
  - cleaning 7
  - help 7, 202
  - locating 2
- copy
  - adjust lightness/darkness 114
  - books 118
  - collate 106
  - enlarge 111
  - from document feeder 101, 102, 104
  - from glass 101, 102, 104
  - improve quality 232, 237, 242
  - Job Build 117
  - Job Mode 117
  - multiple originals 117
  - optimize for text or pictures 113, 234
  - photos 120
  - reduce 111
  - restoring default settings 100
  - set options 98
  - special paper 116
  - two-sided documents 108, 109
- copy multiple pages 104
- copy settings
  - HP Embedded Web Server 182
- counterfeit supplies 38
- cover pages
  - printing on different paper (Windows) 72
- covers, locating 2
- current settings page
  - description 9

- D**
- date/time setting 147
- default gateway, setting 178
- default settings, copy
  - restoring 100
- deleting
  - stored jobs 89
- digital send settings
  - HP Embedded Web Server 183
- digital sending
  - address books 138, 140
  - folders 128
  - job settings 126
  - product memory 131
  - recipient lists 140
  - sending documents 135
  - USB flash drive 132
- document feeder 108
  - copying two-sided documents 108
  - jams 206
  - make copies from 101, 102, 104
  - paper-feeding problems 204
- double-sided copying 108, 109
- drivers
  - changing paper sizes 82
  - changing settings (Mac) 57
  - changing settings (Windows) 56
  - paper types 23
  - presets (Mac) 79
  - settings (Mac) 79
  - universal 54
- duplex 108
- duplex printing
  - Mac 79
- duplex printing (double-sided)
  - settings (Windows) 63
- duplexer
  - jams 219
- E**
- easy-access USB printing 95
- EconoMode setting 190, 229
- edge-to-edge copying 235
- email
  - address books 138, 140
  - recipient lists 140
  - sending documents 135
- email feature
  - enabling 124
- Embedded Web Server (EWS)
  - assigning passwords 193
  - features 180
  - network connection 180
- energy use, optimizing 190
- enlarge
  - copy jobs 111
- envelopes
  - output bin, selecting 32
- error
  - codes 261
- errors
  - software 266
- Explorer, versions supported
  - HP Embedded Web Server 180
- F**
- fax
  - canceling 174
  - feeding problems 257
  - optimize for text or pictures 244
  - required settings 146
  - setup wizard 146
  - speed dial 168
- fax activity log
  - description 9
- fax address book 171
- fax call report
  - description 10
- Fax Reports
  - description 9
- fax settings
  - HP Embedded Web Server 184
- feeding problems 257
- file directory page
  - description 9
- file upload, Mac 187
- firmware
  - update, Mac 187
- first page
  - printing on different paper (Windows) 72
- folders
  - sending to 128
- fonts
  - upload, Mac 187
- formatter
  - security 194
- fraud Web site 38
- fuser
  - jams 216
- G**
- gateway, setting default 178
- general configuration
  - HP Embedded Web Server 181
- group dial. See speed dial
- H**
- hard disks
  - encrypted 194
- heavy paper
  - output bin, selecting 32
- help, control panel 7, 202
- HP Embedded Web Server
  - copy settings 182
  - digital send settings 183
  - fax settings 184
  - general configuration 181
  - HP Web Services 185
  - information pages 181
  - network settings 185
  - other links list 185
  - print settings 182
  - scan settings 183
  - security settings 185
  - troubleshooting tools 184
- HP Embedded Web Server (EWS)
  - features 180
  - network connection 180
- HP ePrint Mobile Driver 92
- HP ePrint, using 91
- HP fraud Web site 38
- HP Smart Print 94
- HP Universal Print Driver 54
- HP Utility 187
- HP Utility, Mac 187
- HP Web Jetadmin 189
- HP Web Services
  - enabling 185
  - HP Web Services, enabling 91

**I**

- information pages
  - HP Embedded Web Server 181
  - printing or viewing 9
- installing
  - product on wired networks, Mac 16
  - software, wired networks 14
- interface ports
  - locating 3, 4
- Internet Explorer, versions supported
  - HP Embedded Web Server 180
- IP address
  - configuring 13, 16
- IP Security 193
- IPsec 193
- IPv4 address 178
- IPv6 address 179

**J**

- jams
  - auto-navigation 205
  - causes of 204
  - clearing 205
  - document feeder 206
  - duplexer 219
  - fuser 216
  - locations 205
  - output bin 207
  - rear door 216
  - recovery 225
  - toner cartridge 214
    - Tray 1 208
    - Tray 2 210
- Jetadmin, HP Web 189
- Job Build, copying 117
- Job Mode, copying 117
- job storage
  - Mac settings 88
- job-separator pages 90
- jobs, stored
  - creating (Windows) 86
  - deleting 89
  - printing 89

**L**

- labels
  - output bin, selecting 32
  - printing (Windows) 69
- landscape orientation
  - changing (Mac) 80
  - selecting, Windows 67
- last page
  - printing on different paper (Windows) 72
- loading
  - staples 50
  - toner cartridges 44
    - Tray 1 27
    - Tray 2 30
- log/report
  - activity log 175
  - billing code report 176
  - blocked fax list report 176
  - fax call report 176
  - speed dial list report 176

**M**

- Mac
  - driver settings 57, 79
  - problems, troubleshooting 268
  - removing software 271
- Mac driver settings
  - Job Storage 88
- Macintosh
  - HP Utility 187
- managing network 178
- margins, small
  - copying 235
- media
  - loading Tray 1 27
  - loading Tray 2 30
  - stapling 50
- memory DIMMs
  - security 194
- modem speed 258
- multiple pages per sheet
  - printing (Mac) 79
  - printing (Windows) 65

**N**

- Netscape Navigator, versions supported
  - HP embedded Web Server 180

- network
  - settings, changing 178
  - settings, viewing 178
- Network Folder, scan to 128
- network settings
  - HP Embedded Web Server 185
- networks
  - default gateway 178
  - HP Web Jetadmin 189
  - IPv4 address 178
  - IPv6 address 179
  - subnet mask 178
- networks, wired
  - installing product, Mac 16
  - installing product, Windows 13
- non-HP supplies 37, 46
- not configured 146

**O**

- on/off button, locating 2
- online help, control panel 7, 202
- optimize copy images 113, 234
- optimize fax images 244
- optimize scanned images 143, 239
- ordering
  - supplies and accessories 36
- orientation
  - changing (Mac) 80
  - selecting, Windows 67
- other links list
  - HP Embedded Web Server 185
- output bin
  - jams 207
  - locating 2

**P**

- page orientation
  - changing (Mac) 80
- page sizes
  - scaling documents to fit (Mac) 81
  - scaling documents to fit (Windows) 75
- pages per sheet
  - selecting (Mac) 79
  - selecting (Windows) 65

- paper
    - covers, using different paper 72
    - first and last pages, using different paper 72
    - jams 204
    - loading Tray 1 27
    - loading Tray 2 30
    - selecting 228
    - supported paper sizes 20
    - supported sizes 20
    - supported types 23
  - paper pickup problems solving 203
  - paper size changing 82
  - paper sizes
    - selecting (Mac) 84
    - selecting custom sizes (Mac) 84
    - selecting custom sizes (Windows) 83
  - paper type selecting (Windows) 69
  - paper types selecting (Mac) 80
  - paper, covers printing (Mac) 80
  - paper, ordering 36
  - part numbers
    - replacement parts 41
    - supplies 41
    - toner cartridges 41
    - trays 43
  - PBX systems troubleshooting 260
  - PCL drivers universal 54
  - PCL font list description 10
  - performance factors Tray 1 200
  - phone lines troubleshooting 260
  - photos copying 120
  - portrait orientation changing (Mac) 80 selecting, Windows 67
  - ports locating 4
  - postcards output bin, selecting 32
  - power connection locating 3, 4
  - power switch, locating 2
  - presets (Mac) 79
  - print drivers supported 54
  - print drivers (Mac) changing settings 57 settings 79
  - print drivers (Windows) changing settings 56
  - print on both sides Mac 79
  - print settings HP Embedded Web Server 182
  - printing from USB storage accessories 95 settings (Mac) 79 stored jobs 89
  - printing on both sides settings (Windows) 63
  - problem-solving no response 248 slow response 249
  - product memory sending to 131
  - product memory, scan to 131
  - PS font list description 10
- R**
- rear door jams 216
  - rear output bin printing to 32
  - recipient lists 140
  - recycling supplies 46
  - reduce copy jobs 111
  - removing Mac software 271
  - replacement parts part numbers 41
  - replacing printing cartridges 47
  - required settings country/region 146
  - resize documents Mac 81 Windows 75
  - restore factory settings 201
  - restoring default settings copy 100
  - rollers cleaning 235, 240, 245
  - rough paper output bin, selecting 32
- S**
- save to device memory enabling 124
  - save to network folder enabling 124
  - Save to product memory 131
  - Save to USB 132
  - save to USB enabling 124
  - scale documents Mac 81 Windows 75
  - scan job settings 126
  - scan settings HP Embedded Web Server 183
  - scanner calibrate 233
  - scanner glass cleaning 232, 237, 242
  - scanning optimize for text or pictures 239 scan pictures 143
  - scanning to email address books 138, 140 job settings 126 recipient lists 140 sending documents 135
  - scanning to folder 128
  - scanning to product memory 131
  - scanning to USB 132
  - security settings HP Embedded Web Server 185
  - security encrypted hard disk 194

- Send to email
    - enabling 124
  - Send to Folder 128
  - sending a fax
    - delete multiple recipients 164
    - to multiple recipients 160
    - using fax address book numbers 171
  - sending to email
    - address books 138, 140
    - job settings 126
    - recipient lists 140
    - sending documents 135
  - service settings 264
  - settings
    - billing codes 152
    - driver presets (Mac) 79
    - drivers 56
    - drivers (Mac) 57
    - required 146
    - restore factory 201
  - shortcuts (Windows)
    - creating 60
    - using 58
  - Sign in
    - control panel 193
  - sleep mode
    - disabling 191
    - enabling 191
  - Sleep Schedule
    - setting 191
  - slow fax reception 258
  - slow fax transmission 260
  - small margins 235
  - small paper
    - output bin, selecting 32
  - software
    - HP Utility 187
    - installing, wired networks 14
    - problems 266
    - uninstalling for Windows 270
    - uninstalling Mac 271
  - solving
    - direct-connect problems 252
    - easy-access USB printing problems 250
    - network problems 253
  - special paper
    - copying 116
    - printing (Windows) 69
  - special paper for covers
    - printing (Mac) 80
  - speed dial
    - creating 160
    - delete 164
    - faxes 168
    - list report 176
  - speed dial list
    - description 10
  - speed, optimizing 190
  - staple cartridge
    - loading 50
    - part number 50
  - stapler
    - loading staples 50
  - staples, loading 50
  - stapling 50
  - status
    - HP Utility, Mac 187
  - status, fax accessory page 256
  - stopping a print request (Mac OS X) 84
  - stopping a print request (Windows) 82
  - storage, job
    - Mac settings 88
  - stored jobs
    - creating (Mac) 88
    - creating (Windows) 86
    - deleting 89
    - printing 89
  - storing
    - toner cartridges 46
  - storing jobs
    - with Windows 86
  - straight-through paper path 32
  - subnet mask 178
  - supplies
    - counterfeit 38
    - non-HP 37, 46
    - ordering 36
    - part numbers 41
    - recycling 46
    - replacing toner cartridges 47
    - status, viewing with HP Utility 187
  - supplies status 227
  - supplies status page
    - description 9
  - supported paper 20
  - system requirements
    - HP Embedded Web Server 180
- T**
- T.30 Trace report 264
  - TCP/IP
    - manually configuring IPv4 parameters 178
    - manually configuring IPv6 parameters 179
  - toner cartridge
    - jams 214
  - toner cartridges
    - loading 44
    - non-HP 37, 46
    - order numbers 46
    - part numbers 41
    - recycling 46
    - replacing 47
    - storage 46
  - toner-cartridge status 227
  - top output bin
    - printing to 32
  - transparencies
    - output bin 32
    - printing (Windows) 69
  - Tray 1
    - jams 208
    - loading 27
  - tray 1
    - capacity 26
  - Tray 2
    - jams 210
    - loading 30
  - tray 2
    - capacity 29
  - trays
    - configure 24
    - locating 2
    - part numbers 43
  - troubleshooting
    - checklist 198
    - direct-connect problems 252
    - easy-access USB printing problems 250
    - jams 204
    - Mac problems 268
    - network problems 253
    - paper feed problems 203

- PBX systems 260
  - slow fax reception 258
  - slow fax transmission 260
- troubleshooting tools
  - HP Embedded Web Server 184
- two-sided copying 108, 109
- two-sided printing
  - settings (Windows) 63

## U

- uninstalling Mac software 271
- uninstalling Windows software 270
- universal print driver 54
- usage page
  - description 9
- USB
  - sending to 132
- USB configuration, Mac 15
- USB configuration, Windows 12
- USB storage accessories
  - printing from 95
- USB, scan to 132

## V

- VoIP 258

## W

- watermarks
  - printing (Mac) 85
  - printing (Windows) 83
- Web browser requirements
  - HP Embedded Web Server 180
- Web services status page
  - description 9
- Web sites
  - fraud reports 38
  - HP Web Jetadmin,
    - downloading 189
  - universal print driver 54
- Windows
  - driver settings 56
  - universal print driver 54
- Windows print drivers
  - supported 54
- wizard, fax setup 146







CF116-90912

